

PowerWave – 8

8 Zone Control Panel Communicator

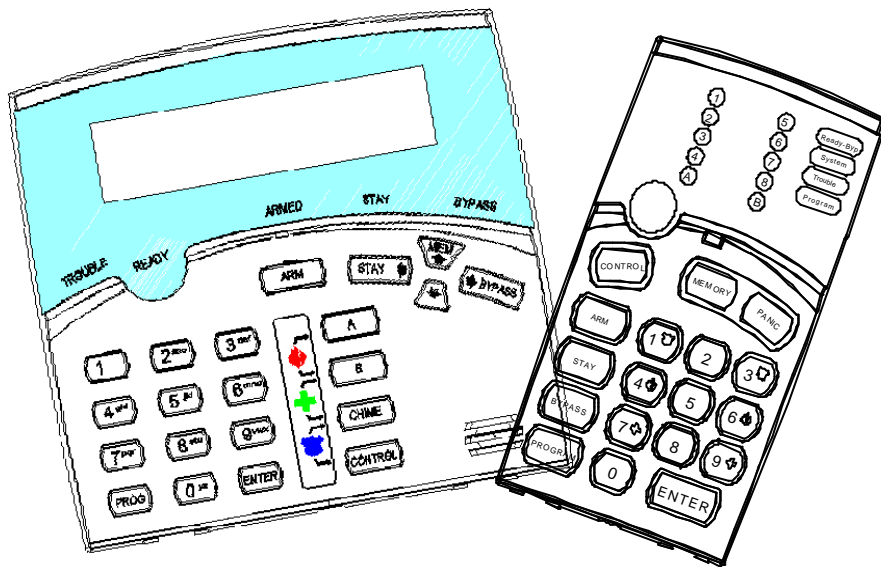

Installation and Programming Guide

CONTENTS

CONNECTION DIAGRAM	3
INPUTS	4
OUTPUTS	5
TELECOM INTERFACE	6
KEYPADS OPTIONS.....	7
KEYPAD INSTALLATION.....	8
MEMORY VIEWING MODE	9
KEYPAD ADDRESS ASSIGNMENT.....	10
KEYPAD FUNCTIONS	11
INSTALLING RX-4 0 RADIO RECEIVER.....	11
ACCESSING & EXITING PROGRAM MODES.....	12
USER CODE PROGRAMMING.....	13
USER CODE OPTIONS.....	14
OUTPUT OPTION PROGRAMMING	14
ZONE ALARMS TO OUTPUTS	16
MONITOR ALARMS TO OUTPUTS	16
24 HOUR ALARMS TO OUTPUTS	16
DAY ZONES TO OUTPUTS	17
ZONE TAMPER ALARMS TO OUTPUTS	17
RADIO PENDANTS TO OUTPUTS	17
TEMPORARY OUTPUT DISABLE	18
AREA "A" OPTIONS	18
AREA "A" OUTPUT OPTIONS	19
AREA "B" OPTIONS	20
AREA "B" OUTPUT OPTIONS	20
ZONE EOL OPTIONS	21
ZONE PROGRAM OPTIONS.....	22
ZONE INACTIVITY TIMER	24
ENTRY DELAY TIMES	24
EXIT DELAY TIMES.....	24
TWO TRIGGER TIMER.....	24
DAY MODE TIMER TO KEYPAD BUZZER.....	24
OUTPUT TIMING OPTIONS	25
LOADING RADIO ZONES	26
RADIO ZONE OPTIONS	26
LOADING RADIO PENDANTS.....	27
RADIO PENDANT OPTIONS "A"	28
RADIO PENDANT OPTIONS "B"	28
KEYPAD PARTITION ASSIGNMENT.....	29
KEYPAD PANIC BUTTON ENABLE/OPTIONS	29
KEYPAD FIRE BUTTON ENABLE/OPTIONS	30
KEYPAD MEDICAL BUTTON ENABLE/OPTIONS	30
MISCELLANEOUS PANEL OPTIONS.#1.....	31
MISCELLANEOUS PANEL OPTIONS.#2.....	32
DURESS DIGIT	33
SETTING THE REAL TIME CLOCK	33
SETTING DAYLIGHT SAVING START/FINISH.....	33
RESET DEFAULTS	33
CLEAR MEMORY EVENT BUFFER.....	34
WALK-TEST MODE ENABLE	34
DATA TRANSFER UNIT(DTU)	34
DIALER PROGRAMMING OPTIONS	35
PHONE NUMBER PROGRAMMING & OPTIONS	38
CONTACT ID REPORTING CODES	41
ACCOUNT CODE	41
4+2 REPORTING CODES	42
VOICE BOARD & DTMF CODE PROGRAMMING	45
UPLOAD/DOWNLOAD SECURITY CODE	46
AUTO-ANSWER RING COUNT & MAINS FAIL REPORT DELAY.....	46
AUTOMATIC TEST REPORTING TIME PROGRAMMING.....	46
PROGRAM SUMMARY	47

CONNECTION DIAGRAM

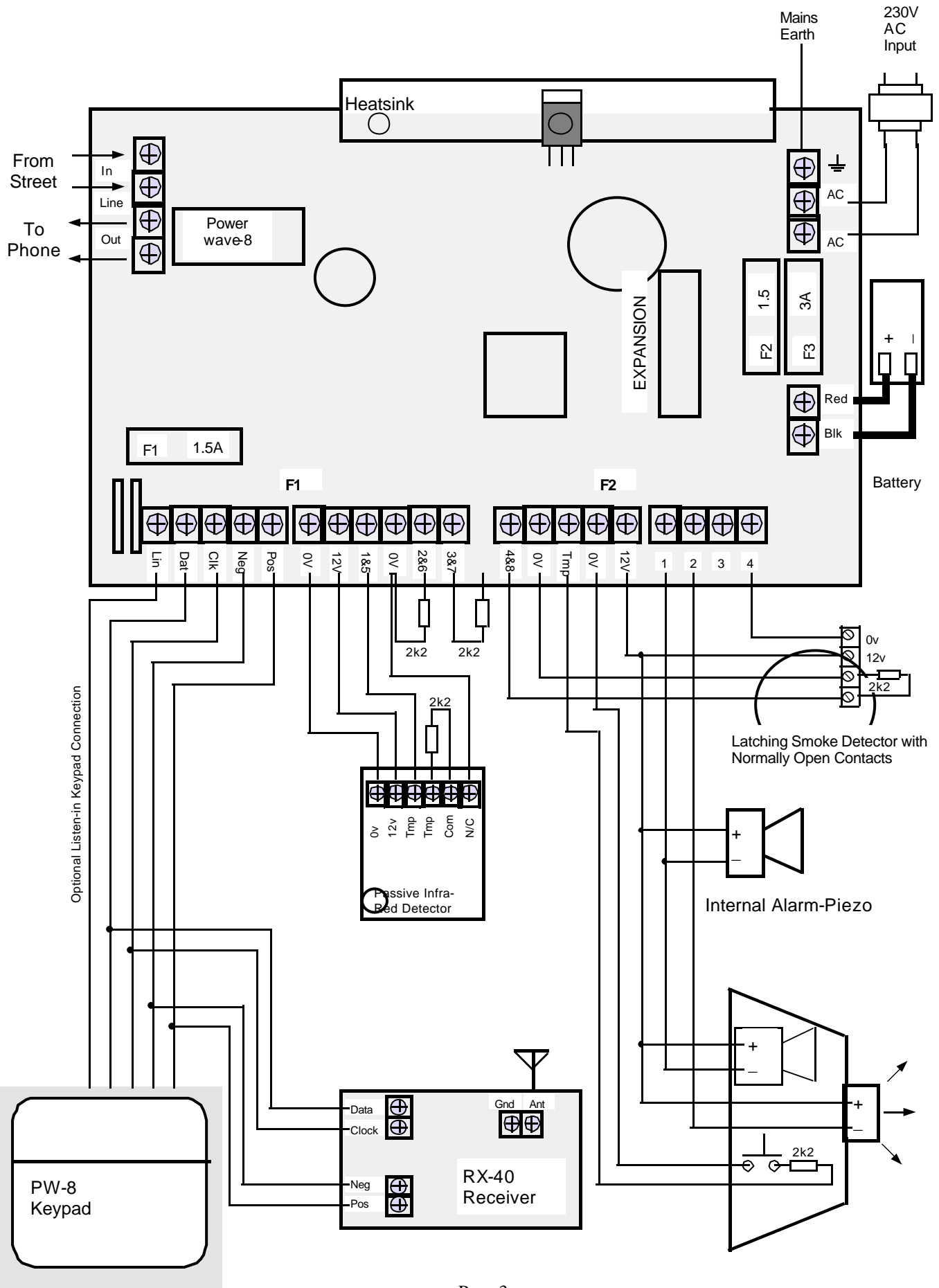

INPUTS

The PW-8 has 5 separate programmable monitored analogue inputs,

- 4 x Programmable, multi-state detection inputs
- 1 x Programmable tamper input (with optional Key-switch functions)

Each input must be terminated with short circuit or the appropriate value of end-of-line resistors, even if the input is unused.

ZONE INPUTS - Each of the 4 zone inputs can be assigned one of the following configuration options

- Type 1 4 ZONE Short circuit input No-End-of-Line (EOL).
- Type 2 4 ZONE End-of-Line 2k2 (EOL) with no tamper.
- Type 3 8 ZONE End-of-Line (EOL) No Tamper.
- Type 4 8 ZONE End-of-Line (EOL) With open & short circuit Tamper.

The following table shows end-of-line resistor configurations.

The reference to LEDS in bold below relate to the program option setting at address P130E.

Zone Type	Low Zone Resistor	Hi Zone Resistor	Tamper End-of-line
Type 1 (4 Zone) LEDS 1-4 off, 5-8 off	N/A (Short circuit)	N/A	N/A
Type 2 (4 Zone) LEDS 1-4 on, 5-8 off	2k2	-	-
Type 3 (8 Zone) LEDS 1-4 off, 5-8 on	4k7	8k2	N/A
Type 4 (8 zone) LEDS 1-4 on, 5-8 on	4k7	8k2	2k2

Type 1

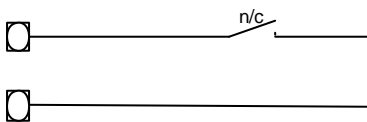

Type 2

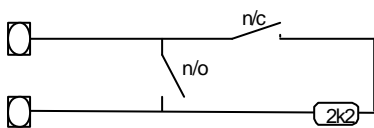

Type 3

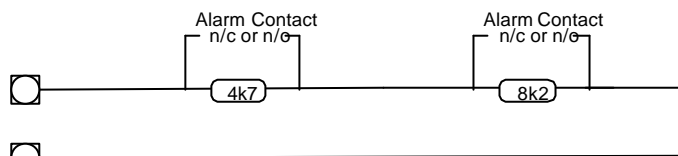

Type 4

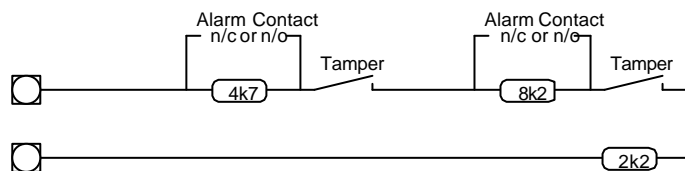

LED at Addr. P130E	Zone Relationship	LED at Addr. P130E	Zone Relationship
LED #1	Zone 1 Short or EOL	LED #5	Zone 5 Enabled
LED #2	Zone 2 Short or EOL	LED #6	Zone 6 Enabled
LED #3	Zone 3 Short or EOL	LED #7	Zone 7 Enabled
LED #4	Zone 4 Short or EOL	LED #8	Zone 8 Enabled

TAMPER - A 24Hr tamper circuit is available for monitoring tamper status of detectors, junction boxes, cabinets and satellite sirens etc. This Tamper circuit is programmable with 2 options (P170E1E) either normally closed loop or 2k2 EOL supervision(the default is normally closed loop). The tamper circuit must be terminated with an end-of-line resistor if 2k2 EOL supervision is selected. The activation events and outputs for this tamper circuit are mapped in the same manner as for detection zones 1-8. Using Dual-End-of-Line resistors (Refer to zones on Page 4) the Tamper input can also provided two key-switches. The Low key-switch (4k7 resistor) operates Partition A while the High key-switch (8k2 resistor) operates partition B. In this configuration the 2k2 resistor must still be installed to seal the system Tamper.

In addition to the Analogue monitoring inputs, you will find the following system inputs on your PW-8 control PCB;

AC - Connect the two low voltage wires (no polarity) from the transformer to the terminals marked AC on the PW-8 PCB. The PW-8 includes a mains transformer rated at 1.4 amps at 17 volts.

EARTH - Always connect the mains earth to the appropriate terminal on the mains terminal block in the control box cabinet. Also connect a lead from this earth point to the terminal marked with the Earth symbol (next to AC terminals) on the PW-8 PCB.

BATTERY - Connect a sealed lead acid rechargeable 12V d.c. battery to the red and black battery leads. Be careful to observe correct polarity as damage may occur from incorrect connection. The minimum recommended battery capacity is 7 amp hours. Battery charge current at these terminals is limited to 350mA maximum. The battery connection is fuse protected by fuse F3 (3A). The panel performs a dynamic load test on the battery every 5 seconds and if it fails the test at any time it will flash the system LED (refer to the "View Memory" chart on page 9 for more details).

LINE IN - This pair of terminals is used to connect the PW-8 to the incoming telephone line from the street. The communicator uses this line for reporting.

LINE OUT - This pair of terminals is used to connect telephones and other communication equipment to the incoming phone line via the PW-8 controller. The telephone line is passed through the PW-8 controller to ensure that the line is available to the controller when it is required.

OUTPUTS

12 VOLT OUTPUTS - There are two 12 volt dc outputs available on the PW-8 PCB. These 12 volt outputs are both regulated and fuse protected. These outputs are marked 12v and 0v, and are supplied by fuse F2. A maximum total load of 1 amp may be drawn from these terminals.

OUTPUTS 1 & 2 - These fully programmable, high current, open collector (high-going-low) type FET outputs are capable of switching up to **1A @ 12V d.c.** These 2 outputs are normally set as switched outputs, providing power for 12v sirens or piezos. If required, these outputs can be programmed to be siren outputs designed to drive an 8 ohm 10 watt horn speaker per output. Also if a horn speaker is connected to **Output #1** you may select (Refer to P190E program address) the listen-in feature to this output as well so that the dialing sequence can be heard at the speaker.

OUTPUTS 3 & 4 - These are low current, open collector (high-going-low) type outputs capable of switching no more than **100mA**. Like Outputs 1 & 2 they are fully programmable.

NOTE: - **Connecting devices which draw current in excess of 100mA to outputs 3 & 4 will cause permanent damage to the Pw-8 controller.**

KEYPAD PORT - The terminals marked *POS*, *NEG*, *CLOCK*, & *DATA* make up the communications port which the keypads and other intelligent field devices use to talk to the PW-8 controller. The terminals are connected to corresponding terminals on the remote devices. The keypad 12v output I(*POS,NEG*) is also protected by fuse F1.

EXPANSION PORT - The expansion port is for the connection of the Arrowhead RS232 serial board, 90 second voice board or EPROM data transfer board (DTU). The serial board allows for the direct connection of a PC running the Upload/Download software. The 90 second voice board allows voice messages to be programmed for monitoring purposes and remote control via a telephone.

TELECOM INTERFACE

The communicator facility of this PW-8 controller has been designed to provide optimum flexibility in the way in which alarm events are reported. This flexibility includes options for reporting to a central monitoring station using Ademco Contact ID format, a domestic reporting option using alternating siren tones, a format for reporting alarms to an alpha numeric pager and a powerful speech dialer.

In accordance with the statutory requirements of the Telepermit standards we must bring the following points to your attention;

A readily accessible disconnect device shall be incorporated into the 230V fixed wiring.

In the event of any problem with this device, the by-pass switch should be operated. The user is to then arrange with the installer of the device to make the necessary repairs. Should the matter be reported to Telecom as a wiring fault, and the fault be proven to be due to the alarm panel, a call out charge will be incurred.

Should the Alert control panel require relocation the Telecom connection must be disconnected before the power is disconnected. Similarly when reconnecting the dialer, it is necessary to power up the Alert before connecting the dialer to the Telecom Network.

Connection to the Telecom network should be made in accordance with Access Standards Newsletter #65 dated November 1993. This connection is to be readily accessible to allow disconnection in the event of a fault. An example of this connection method is shown below.

NOTE: The telephone line must not enter the cabinet through the same cable entry hole as any 230 volt mains cables. A separate cable entry must be used for 230 volt cabling

When using one of the knock-outs around the side of the cabinet for supply entry, a suitable bushing must be used where the supply cables pass through a knock-out.

The transmit level from this device is set at a fixed level and because of this there may be circumstances where this device does not give its optimum performance. Before reporting such occurrences as faults, please check the line with a standard Telepermitted telephone, and do not report a fault unless the telephone performance is impaired.

This automatic dialing equipment shall not be set up to make calls to the Telecom "111" Emergency Service

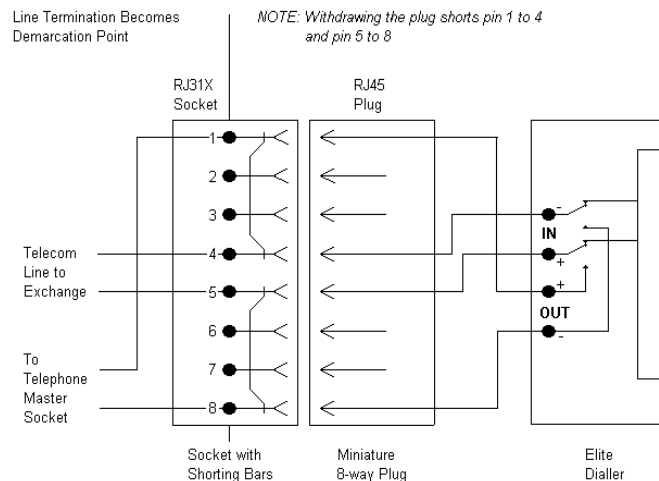

PW-8 KEYPAD OPTIONS

LCD-KEYPAD

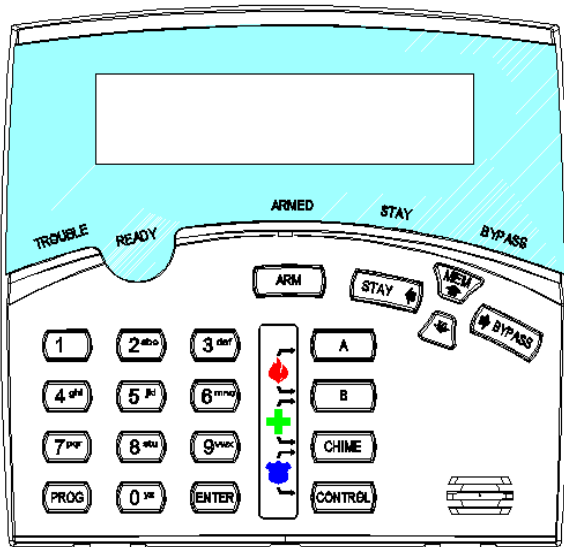

- ✓ Multiple language versions
- ✓ LED indicators ... READY , ARMED, TROUBLE....
- ✓ 3 KeyPad activated alarms FIER,MEDICAL, PANIC
- ✓ Audible feedback of correct key entries, pre-alert , system trouble
- ✓ Backlit keypad and display with boost control
- ✓ keypad tone control
- ✓ Large 32-character LCD display
 - system menus and prompts
 - trouble indications
 - time &date clock
 - viewable event buffer
 - all system parameters programming
 - customizable zone labeling

LED-KEYPAD

- ✓ LED indicators ... READY , ARMED, TROUBLE....
- ✓ 4 KeyPad activated alarms FIER,MEDICAL, PANIC
- ✓ Audible feedback of correct key entries, pre-alert , system trouble
- ✓ Backlit keypad
- ✓ Viewable event buffer
- ✓ All system parameters programmable

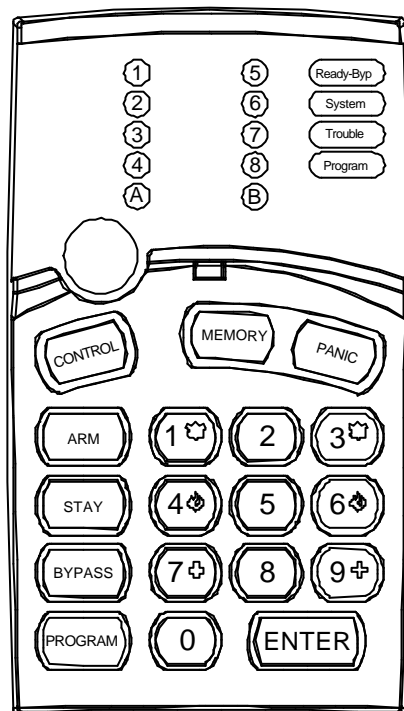

KEYPAD LED or LCD INSTALLATION

INSTALLATION

Remove the Well Mount Bracket (Back cover) by unscrewing the holding screw at the bottom side. Screw the bracket to the wall using the mounting holes provided with the necessary number of screws. Make sure the base is mounted right side up.

When fixing the bracket to the wall make sure the top of the screw heads will not touch or short out the underside of the PCB when the top half of the keypad is reinstalled.

Insert the wire through the wire access hole at centre of the base.

Connect the 4 or 5 wires to the 5 way terminal block on the back side of the keypad PCB, make sure to match the cables up with the terminals as marked on the control panel's keypad port.

The 5th wire is connected from the "LINE" terminal of the keypad to the "Lin" (Listen) terminal of the PW8 PCB keypad port.

Once the cables have been terminated and the required address allocated (see section below) replace the front half of the keypad onto the bracket by first engaging the clips at the top edge and then close the front down and screw it in at the bottom. Now stick the zone list provided to the inside of the keypad cover.

WIRING

The PW8 keypad connects to the PW 8 Controller via a 4 or 5 wire data security cable. A maximum of 8 LED keypads can be connected, each wired in parallel. A 5th wire may be used to provide a "Listen-in" facility at the keypad when an PW8 communicator panel is being used.

The maximum recommended cable using standard 0.2mm security cable is 50m. Cable runs exceeding this distance may require 0.5mm cable. Always use good quality cable. Some installations may require CAT5 data cable to ensure data integrity in noisy sites.

User information :

**Keypad LCD — Power Wave CR16M-LCD Keypad
Users' Operating and Programming Guide**

**Keypad LED — Power Wave – 8
Users' Operating and Programming Guide**

When the PW-4 is displaying codes and address values in program mode it may be necessary to display the 9 and 0 digits. As there are no Zone indicators for 0 and 9 the "A" and "B" indicators are used.

i.e.. When displaying values in program mode

LIGHT\INDICATION	OFF	ON STEADY	FLASHING
READY\BYP	Zone Unsealed	All Zones Sealed	A Zone is bypassed
SYSTEM	Normal	System Alarm Reset	New System Alarm
TROUBLE	Normal	Trouble Alarm Active	New Trouble Alarm
PROGRAM	Run Mode	Client Program Mode	Installer Program Mode or Control Function Active
READY\BYP & PROGRAM	-	Bypass Mode Active (Zones can be Bypassed)	-
ZONES 1-4	Zone Secure	Zone Violated	Zone in Alarm
Armed A	Partition A Disarmed	Partition A Armed	Partition A STAY Mode
Armed B	Partition B Disarmed	Partition B Armed	Partition B STAY Mode

VIEW MEMORY MODE

When viewing the memory event buffer at the keypad by pressing the "MEMORY" button, the first thing that will always be displayed is the "SYSTEM" LED. If the system led turns on but no other Zone LED's are on at the same time, this means that there are no current system alarms. If a zone LED or LED's are On then this indicates system alarms that have not yet cleared. The zone LED's 1-8 are pre-defined as to what system alarm they will display. These system alarm indications are shown in the table below. Following the display of current system alarms the panel will then sequence through the 127 historical memory events starting at the most recent event. The second table shows the alarm events that can be displayed in memory mode and what indicators are used to show them.

LED # 1	Battery Low	LED # 5	Radio Pendant Battery Low
LED # 2	Mains Failure	LED # 6	Supervised Detector Failure
LED # 3	Telephone Line Failure	LED # 7	Zone Inactivity Timeout
LED # 4	Radio Detector Battery Low	LED # 8	Dialer Kiss-off Failure

EVENT TYPE \ INDICATION ?	DEVICE	INDICATOR	STATUS
ACTIVATION	Zones 1-4	LED's 1-4	On Steady
BYPASS	Zones 1-4	READY/BYPL LED's 1-4	On Steady On Steady
DETECTOR TAMPER (SHORT CIRCUIT)	Zones 1-4	TROUBLE LED's 1-4	Flashing On Steady
DETECTOR TAMPER (OPEN CIRCUIT)	Zones 5-8	TROUBLE LED's 5-8	Flashing On Steady
CABINET TAMPER	Cabinet or Satellite Siren	TROUBLE	Flashing
LOW BATTERY	Controller Battery	SYSTEM LED 1	On Steady On Steady
MAINS FAILURE	Controller Mains Supply	SYSTEM LED 2	On Steady On Steady
RADIO ZONE LOW BATTERY	Radio PIR Zone 1-4	LED's 1-4	Flashing
PENDANT LOW BATTERY	Radio Key User 1-4	TROUBLE LED's 1-4	On Steady Flashing
PANIC BUTTON (or BUTTONS 1&3 PRESSED TOGETHER)	Keypad Panic	SYSTEM	Flashing
FIRE ALARM (BUTTONS 4&6 PRESSED TOGETHER)	Keypad Fire	SYSTEM AREA A	Flashing Flashing
MEDICAL ALARM (BUTTONS 7&9 PRESSED TOGETHER)	Keypad Medical	SYSTEM AREA B	Flashing Flashing
PENDANT PANIC	Radio Key User 1-4	SYSTEM LED 1-4	Flashing Flashing
ARMED A	Area A is Armed	AREA A	On Steady
ARMED B	Area B is Armed	AREA B	On Steady
STAY MODE A	Area A STAY Mode ON	AREA A	Flashing
STAY MODE B	Area B STAY Mode ON	AREA B	Flashing
DURESS ALARM	Duress Alarm	TROUBLE AREA A & B	On Steady Flashing
SUPERVISED RADIO ALARM	Supervised Radio Passive Infra-Red	SYSTEM TROUBLE LED's 1-4	On Steady Flashing Flashing
ZONE INACTIVITY ALARM	Zones 1-4	READY/EXCL TROUBLE LED's 1-4	On Steady On Steady On Steady
TELEPHONE LINE FAILURE	Phone Line Failure	TROUBLE LED 3	On Steady On Steady

LED KEYPAD ADDRESS ASSIGNMENT

Each of the 8 possible LED keypads which are able to be connected to your PW8 panel must be addressed individually to avoid BUS conflicts when multiple users are operating different keypads simultaneously. As default, each keypad comes addressed as #1 (Switches A B and C at ON position).

To assign a keypad as address #2, change switch A to OFF position.

To assign a keypad as address #3, change switch B to OFF position.

To assign a keypad as address # 4, change switches A and B to OFF position.

INDIVIDUAL KEYPAD ADDRESS SETTING

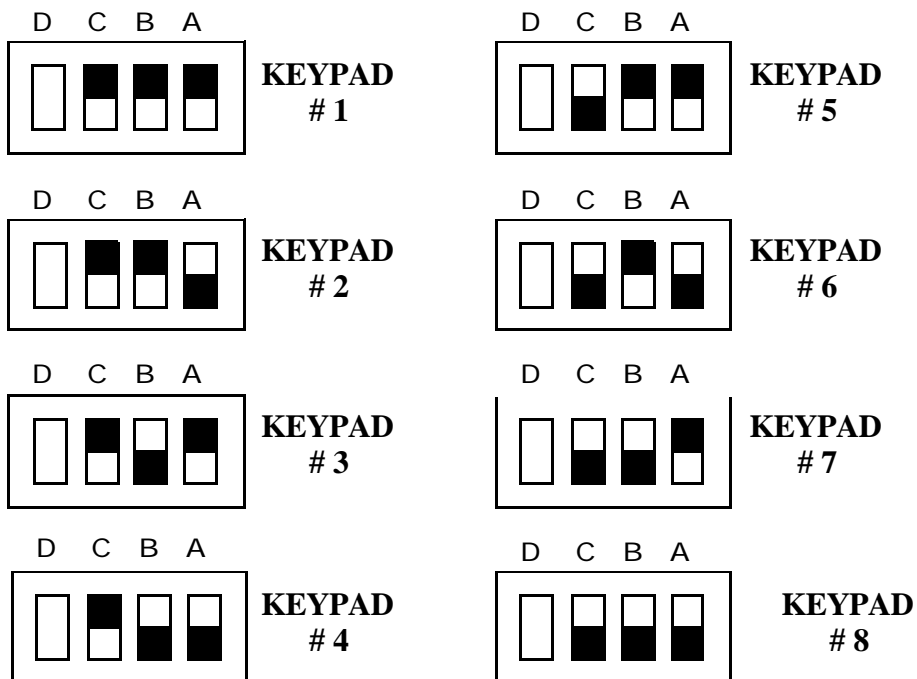

KEYPAD TAMPER OPTION SETTING

Switch marked D used to Enable and Disable the Keypad Tamper option:



LED KEYPAD FUNCTIONS

The PW-8 LED Keypad consists of; an 18 button, backlit silicone rubber keypad, 14 LED ICON indicators and an internal piezo buzzer housed in a modern white plastic housing. The plastic housing has a hinged front lid to cover and protect the rubber buttons when not in use. All the electronics are contained on a single circuit board inside the housing.

BUTTONS

The 18 silicone rubber buttons are used for the following functions.

In normal operating mode the numeric keys are used for entering Access Codes. In Program Mode the numeric keys are used for entering options & new values.

The buttons with text labels are used as function buttons and select the options indicated by the text and normally precede other button presses, e.g. to enter Bypass Mode press <BYPASS> and the numeric key corresponding to the zone number you wish to be bypassed.

The **PROGRAM** Key is used to prefix option selections in the program modes e.g.<PROGRAM> 4 <ENTER> selects User Code 4. The **PROGRAM** key is also used prior to a Master Code to enter user program mode from normal operating mode.

The **ENTER** Key is used to enter access or program codes. It is normally used at the end of a button sequence.

The **CONTROL** button, if enabled, is used to isolate day zone audible alarms if temporarily not required and/or to directly control outputs if programmed.

ICON LED INDICATORS

The ICON LED indicators are used to display system conditions including Zone status, Battery state, Tamper etc. Please refer to the LED table on page 7 for a full explanation of the conditional displays.

INSTALLING RX-40 RADIO RECEIVERS

The PW8 is fully high level compatible with the new RX-40 radio receivers. The addition of this receiver will add wireless capability to your system in the form of wireless PIR detectors, Wireless Radiokey transmitters and wireless reed switch transmitters. The RX receiver connects to the same communications port as the keypads and can be installed, either inside the cabinet, or if preferred, may be installed at a remote location. The RX-40 are available in 3 frequencies, 303.875MHz, 433.92 MHz or 868 MHz.

The RX receivers requires 4 cores and can successfully be run in 0.2mm unscreened cable over a distance of up to 100metres. Like the keypads the RX-16 and RX-40 has 12v connections labeled *POS and NEG* which are wired to the 12v supply and CLK and DATA terminals for connection to the communications bus.

The green LED fitted to the RX receivers will indicate when the unit is in "Learn" mode (Flashing - see P601E) or when it is receiving an actual radio transmission (On Steady)

PROGRAMMING YOUR PW-8

HOW TO PROGRAM

The programming sequence always follows this pattern:

<PROGRAM> - <1,2 or 3 digit address> - <ENTER>

3 short beeps if OK - 1 long beep if error

The LEDs will display current value or status

Enter the new value or option <New Value> - <ENTER>

3 short beeps if OK - 1 long beep if error

Throughout this manual you will see program instructions expressed as

P 10 E 5 E as an example.

***In this example the <P> represents the **PROGRAM** key and <E> represents the **ENTER** key.

ACCESS TO PROGRAMMING ON POWER UP (INSTALLER MODE)

When power is applied to the controller for the first time, with the panel tamper input open, the panel will inhibit tamper alarms and ready the panel to enter INSTALLER PROGRAM Mode (unless the Installer Lock-out option P170E2E has previously been enabled). At this point you can go to any keypad which is connected to the panel and press "PROGRAM" "ENTER" which will automatically put that keypad into full Program mode, Program LED Flashing. (NOTE: Only one keypad can be in Program mode at any time)

ACCESS TO INSTALLER PROGRAM MODE FROM RUN MODE

Before you can enter Installer program mode, the panel must not be Armed or in STAY mode

Press <PROGRAM> - <Code 11 (Installer Code)> - <ENTER>

Program light will Flash

Note: Default Installer Code (Code 11) is 000000.

You are now in Installer Program Mode. Any program addresses may be viewed or changed in this mode.

Note: Using LCD KP - Where there are multiple options at one address , Press <CONTROL>+<BYPASS> to prompt the options description. Press <MEM> to display all options at one address . To switch back to address mode press <CONTROL>+<BYPASS> again .

ACCESS TO CLIENT PROGRAM MODE FROM RUN MODE

Press <PROGRAM> - <User Code> - <ENTER>

Program light On Steady

Note: Default User Code (P1) is 123.

You are now in Client Program Mode. Only User Codes 1-10 can be viewed or changed in this mode. Codes may be denied access to Client mode, allowed access to change their code only or allowed access to view & change all user codes.

RESETTING BACK TO FACTORY DEFAULT SETTINGS (From Install Mode Only)

This address allows you to reset the panel back to the factory defaults (Reset All defaults).

e.g. To reset All System defaults including User Codes (P620 E)

Press <PROGRAM> - 620 - <ENTER>
3 beeps - Program light flashing

After the system configuration has been reset back to defaults, all values, options & Codes will be set to the values shown in the Program Option Summary as defaults. These value & option selections have been chosen as the most common set-up for the majority of systems.

P621-P625 allow selective defaults to be set (refer to program summary at the back of the manual for more details).

TO EXIT PROGRAM MODES

To exit either program mode when you have finished programming:

Press <PROGRAM> - <ENTER>
Program light goes out

The panel is now back in Run Mode, any program changes you have made will have replaced previous values and be in effect.

Note: During programming Tamper and 24 hour alarms are disabled which allows quiet access to the panel, detectors and satellite siren units etc. On exiting program mode, all inputs are scanned and if any tamper or 24 Hr alarms are present an activation will occur.

PROGRAMMING USER CODES

Note: Where there are multiple options at one address, options 0 & 9 have been reserved. Entering a 0 at the address will turn all options off whereas entering a 9 will turn all options on.

USER CODES - (P1E to P10E) & (P11E)

There are 11 codes available in the PW-8, 10 user codes and 1 install code. The user codes are located in addresses 1-10. As default, Code 1 has Master Code permissions and must be used to enter Client program mode. The Installer code is stored at address 11 and is used to access *Installer* Program mode.

Codes 1-10 may be varied in length from 1 to 6 digits. Code 11 must be 3-6 digits.

To program a User Code you must first be in client or installer program mode, then select the address from 1-10. (If there is already a code programmed at this address, it will be flashed back to you) Now enter the code then press the **ENTER** key.

e.g.. P 1 E 1234 E
3 beeps - program light on solid or flashing

In this example we have set Code 1 (Master Code) to be 1234.

e.g.. P 5 E 567 E
3 beeps - program light on solid or flashing

In this example we have set code 5 to be 567

To replace a code simply enter the new code in the same address as the old code. This will overwrite the previous code but maintain the user permissions as mapped to that user number.

To clear or delete a code simply enter the Bypass button at the address where the old code is stored.

e.g.. P 3 E <BYPASS> E
3 beeps - Program light on solid or flashing
User Code # 3 Erased

When flashing back codes and values Zone indicators 1-8 are used to indicate digits 1-8. The digit 0 is indicated by the "A" light and 9 is indicated by the "B" light.

User 5 Code
567

USER CODE OPTIONS

USER CODE PERMISSIONS (Code Options) - P21E-P30E

- Option 1 - Code has Area A permissions
- Option 2 - Code has Area B permissions
- Option 3 - Code can Arm Area
- Option 4 - Code can Disarm Area
- Option 5 - Code can turn STAY on
- Option 6 - Code can turn STAY off
- Option 7 - Code can Program their own code
- Option 8 - Code can Program Other Codes

User 1 Options

1 2 3 4 5 6 7 8

NOTE: Options 3,4, 5 & 6 are used in conjunction with options 1 & 2 whereby options 3,4,5 & 6 determine the functions and options 1 & 2 determine the area of operation. If option 8 is on for the user, that user can change the telephone numbers and change the Real Time Clock.

INSTALLER CODE - P11E

This code is used to enter full Installer Program mode (Program LED flashing). The default installer code is 000000. To change this code enter your new installer code at the P11E address. The new code will be flashed back to you automatically. The Program code may vary from 3-6 digits in length.

Installer Code

000000

PROGRAMMING OUTPUT OPTIONS

NOTE: With all output programming options we refer to outputs 1-8. Only outputs 1-2 are available as standard, with outputs 3-8 requiring the connection of the optional 4 way output expander unit that connects to the keypad buss (the output expander provides 4 change-over relay contacts).

OUTPUT OPTIONS A- P31E-P38E

This block of addresses (P31E - P38E) are used to map output modifiers to each of the 8 outputs available on the PW-8.

- | | | |
|-------------|-----------|--|
| P31E | 1E | Invert output - Default off |
| | 2E | Flash output - Default off |
| | 3E | Single pulse to output - Default off |
| | 4E | Lockout output once reset - Default off (P34E =ON) |
| | 5E | Siren Driver to output - Default off |
| | 6E | “Control” button & DTMF Remote Control can operate output - Default off |
| | 7E | Output flashes on a 24 hour zone alarm - Default off |
| | 8E | Day zones (CHIME) linked to pulse timer - Default off |

Options A O/P 1

- - - - -

- Option 1 **Invert Output** - This option is used to invert the normal state of the output. The PW-8 uses open collector type transistor switches and the default state of all outputs is off or high. When in alarm the transistor switch is turned on and the output is switched low. The invert option reverses this function.
 - Option 2 **Flash Output** - This option causes the output to turn on and off at a rate set by the pulse timer for this output (P221E-P228E) when in alarm and is normally used to flash a lamp during an activation.
 - Option 3 **Single Pulse to Output** - This option, when applied, produces a single pulse at the output during an alarm (the pulse time is the value programmed at the output pulse timer address, P221E-P228E).
 - Option 4 **Lockout Once Reset** - This option is used to limit the output to one operation per arming period.
 - Option 5 **Siren Driver to Output** - This option causes the output to be a modulated output designed to drive 8 ohm 10 watt horn speakers directly. Outputs 1 & 2 can have the siren driver feature. A different tone is generated at output 1 to that at outputs 2.
- NOTE: DO NOT CONNECT A HORN SPEAKER TO OUTPUT 1 or 2 WITHOUT FIRST TURNING**

THIS OPTION ON OTHERWISE DAMAGE MAY OCCUR TO THE OUTPUT CONCERNED.

- Option 6 **“Control” button & DTMF Remote Control can operate output** - The “Control’ button on the PW-8 keypad can be used to turn outputs on or off. Also, if the optional 90 second voice board is fitted, the outputs can be turned On or Off remotely via a Touchtone (DTMF) phone. For this to happen this option must be turned on for the output/s concerned. To turn an output on locally at the keypad the operator simply presses the “Control’ button at which time the “System” & “Program” LED’s will illuminate to indicate that the Control mode is active. If any controllable outputs are currently on, the relevant green led (LEDS 1-8) will be on. The operator can now press a button relating to the output/s they wish to control e.g. pressing the “1” button will turn output 1 on or off, The “2” button for output 2 etc. When an output state is changed the LED will indicate the change of state. When finished the operator then presses the “Enter” button to cancel the Control mode and return to normal. To operate the output/s via a telephone please refer to the instructions supplied with the voice board.
- Option 7 **Flash 24 hour alarm** - If a 24 hour zone activates the alarm this option will cause the output to flash at a rate equal to the value set for the pulse timer (P221E-P228E).
- Option 8 **Day Zones (CHIME) Linked to Pulse Timer** - Day Zones programmed to this output will pulse at the pulse timer rate (P221E -P228E) for the duration of the day zone to output timer (P211E-P218E)
P32E - P38E As per P31E above for Outputs 2-8

PROGRAMMING OUTPUT OPTIONS cont.

OUTPUT OPTIONS B - P41E - P48E

In this block of addresses P41E relates to output #1, P42E relates to output #2 etc

- P41E 1E** Pendant Panic to Output - Default **on (P43E-48E = OFF)**
- 2E** Keypad Panic to Output - Default **on (P43E-48E = OFF)**
- 3E** Keypad Fire to Output - Default **off**
- 4E** Keypad Medical to Output - Default **off**
- 5E** Cabinet Tamper to Output- Default**on (P43E-48E = OFF)**
- 6E** Duress Alarm to Output - Default **off**
- 7E** Mains Fail to Output - Default **off**
- 8E** Battery Low to Output - Default **off**

Options B O/P 1
1 2 - - 5 - - -

- Option 1 **Pendant Panic to Output** - This option is used to map the operation of the Radio Pendant panic button to an output i.e. when the Radio Panic button is pressed any output with this option enabled will turn on.
- Option 2 **Keypad Panic to Output** - This option is used to map the Keypad Panic Button, or the 2 button Panic function to an output. Keypad Panics are generated when a user presses the Panic Button or buttons **1 & 3 Simultaneously** at the keypad.
- Option 3 **Keypad Fire to Output** - This option is used to map the manual Keypad Fire alarm function to an output. The keypad Fire alarm is generated when a user presses buttons **4 & 6 Simultaneously** at the keypad.
- Option 4 **Keypad Medical to Output** - This option is used to map the manual Keypad Medical alarm function to an output. The keypad Medical alarm is generated when a user presses buttons **7 & 9 Simultaneously** at the keypad.
- Option 5 **Cabinet Tamper to Output** - This option is used to map activations of the common Tamper Input to an output. This common tamper input is normally used to STAY the panel cabinet and satellite tamper switches.

- Option 6 **Duress Alarm to Output** - This option will map the Duress Function to an output. Programming of the Duress Digit is at address P230E.
- Option 7 **Mails Fail To Output** - A mains failure will be indicated at this output when option 7 is enabled at this address. The Alarm Reset Timer must be set to "0" when this option is used.
- Option 8 **Low Battery** - A battery Low condition will be indicated at this output when option 8 is enabled at this address. The alarm reset timer must be set to "0" when this option is used.

P42E - P48E As per P41E above for Outputs 2-8

MAPPING ZONE ALARMS TO OUTPUTS

ZONE ALARM MAPPING TO OUTPUTS - P51E - P58E

When a zone is in alarm (during the ARMED state only) this block of addresses allows individual zones to be mapped to selected outputs. The default setting is that zones 1-8 will turn on all outputs 1-8 when in alarm.

- P51E** Zone Alarms to Output #1. Options=Zones 1-8 (Default=**1-8**)
- P52E** Zone Alarms to Output #2. Options=Zones 1-8 (Default=**1-8**)
- P53E** Zone Alarms to Output #3. Options=Zones 1-8 (Default= 0)
- P54E** Zone Alarms to Output #4. Options=Zones 1-8 (Default= 0)
- P55E** Zone Alarms to Output #5. Options=Zones 1-8 (Default= 0)
- P56E** Zone Alarms to Output #6. Options=Zones 1-8 (Default= 0)
- P57E** Zone Alarms to Output #7. Options=Zones 1-8 (Default= 0)
- P58E** Zone Alarms to Output #8. Options=Zones 1-8 (Default= 0)

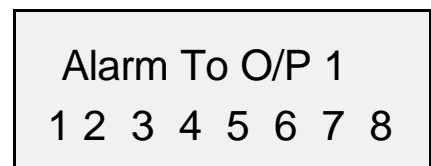

MAPPING STAY ZONE ALARMS TO OUTPUTS

STAY ZONE ALARM MAPPING TO OUTPUTS - P61E - P68E

When a Stay Mode zone is in alarm (during the STAY state only) this block of addresses allows individual zones to be mapped to selected outputs. The default setting is that zones 1-8 will turn on output 2 only when a STAY mode alarm occurs.

- P61E** Stay Mode Zone Alarms to Output #1. Options=Zones 1-8 (Default=**1-8**)
- P62E** Stay Mode Zone Alarms to Output #2. Options=Zones 1-8 (Default=**1-8**)
- P63E** Stay Mode Zone Alarms to Output #3. Options=Zones 1-8 (Default=None)
- P64E** Stay Mode Zone Alarms to Output #4. Options=Zones 1-8 (Default=None)
- P65E** Stay Mode Zone Alarms to Output #5. Options=Zones 1-8 (Default=None)
- P66E** Stay Mode Zone Alarms to Output #6. Options=Zones 1-8 (Default=None)
- P67E** Stay Mode Zone Alarms to Output #7. Options=Zones 1-8 (Default=None)
- P68E** Stay Mode Zone Alarms to Output #8. Options=Zones 1-8 (Default=None)

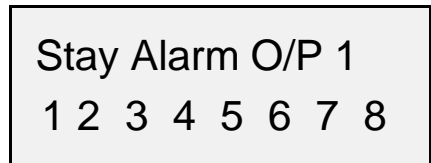

MAPPING 24 HOUR ZONE ALARMS TO OUTPUT

24 HOUR ZONE ALARM MAPPING TO OUTPUTS - P71E - P78E

When a 24 Hour zone is in alarm this block of addresses allows individual zones to be mapped to selected outputs. The default setting is that zones 1-8 will turn on output 2 only when a 24 Hour alarm occurs.

- P71E** 24 Hour Zone Alarms to Output #1. Options=Zones 1-8 (Default=**1-8**)
- P72E** 24 Hour Zone Alarms to Output #2. Options=Zones 1-8 (Default=**1-8**)
- P73E** 24 Hour Zone Alarms to Output #3. Options=Zones 1-8 (Default=None)
- P74E** 24 Hour Zone Alarms to Output #4. Options=Zones 1-8 (Default=None)
- P75E** 24 Hour Zone Alarms to Output #5. Options=Zones 1-8 (Default=None)
- P76E** 24 Hour Zone Alarms to Output #6. Options=Zones 1-8 (Default=None)

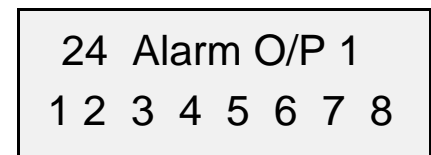

- P77E 24 Hour Zone Alarms to Output #7. Options=Zones 1-8 (Default=None)
- P78E 24 Hour Zone Alarms to Output #8. Options=Zones 1-8 (Default=None)

MAPPING DAY ZONES TO OUTPUTS

DAY ZONES TO OUTPUTS - P81E - P88E

When a Day zone is unsealed this block of addresses allows individual zones to be mapped to selected outputs. The default setting is that no Day zones are mapped to any of the 8 outputs.

- P81E Day Zones to Output #1. Options=Zones 1-8 (Default=None)
- P82E Day Zones to Output #2. Options=Zones 1-8 (Default=None)
- P83E Day Zones to Output #3. Options=Zones 1-8 (Default=None)
- P84E Day Zones to Output #4. Options=Zones 1-8 (Default=None)
- P85E Day Zones to Output #5. Options=Zones 1-8 (Default=None)
- P86E Day Zones to Output #6. Options=Zones 1-8 (Default=None)
- P87E Day Zones to Output #7. Options=Zones 1-8 (Default=None)
- P88E Day Zones to Output #8. Options=Zones 1-8 (Default=None)

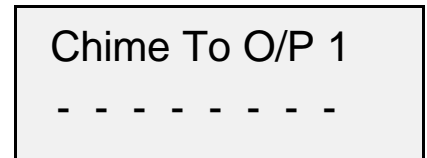

MAPPING ZONE TAMPERS TO OUTPUTS

ZONE TAMPER MAPPING TO OUTPUTS - P91E - P98E

When a zone input is set for Dual-End-of-Line (P130E) the short & open circuit tampers are automatically enabled for that zone input. This option allows the zone tamper alarms to be mapped through to individual outputs. **Led 1-4 is a short on the Zone 1-4 and a Led 5-8 is an open loop in Zone 5-8.**

- P91E Zone Tamper to Output #1. Options= Zone Tampers 1-8 (Default=**1-8**)
- P92E Zone Tamper to Output #2. Options= Zone Tampers 1-8 (Default=**1-8**)
- P93E Zone Tamper to Output #3. Options= Zone Tampers 1-8 (Default=**1-8**)
- P94E Zone Tamper to Output #4. Options= Zone Tampers 1-8 (Default=None)
- P95E Zone Tamper to Output #5. Options= Zone Tampers 1-8 (Default=None)
- P96E Zone Tamper to Output #6. Options= Zone Tampers 1-8 (Default=None)
- P97E Zone Tamper to Output #7. Options= Zone Tampers 1-8 (Default=None)
- P98E Zone Tamper to Output #8. Options= Zone Tampers 1-8 (Default=None)

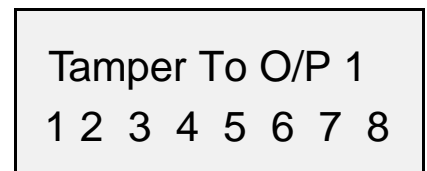

MAPPING RADIO KEYS TO OUTPUTS

RADIO KEY(PENDANT) MAPPING TO OUTPUTS - P101E - P108E

When a Radio Key is to be used to operate a garage door or similar function this block of addresses allows individual Radio Keys to be mapped to selected outputs. The default setting is that none of the 8 Radio Keys are mapped to any outputs.

- P101E Radio Key to Output #1. Options=Pendant 1-8 (Default=None)
- P102E Radio Key to Output #2. Options=Pendant 1-8 (Default=None)
- P103E Radio Key to Output #3. Options=Pendant 1-8 (Default=None)
- P104E Radio Key to Output #4. Options=Pendant 1-8 (Default=None)
- P105E Radio Key to Output #5. Options=Pendant 1-8 (Default=None)
- P106E Radio Key to Output #6. Options=Pendant 1-8 (Default=None)
- P107E Radio Key to Output #7. Options=Pendant 1-8 (Default=None)
- P108E Radio Key to Output #8. Options=Pendant 1-8 (Default=None)

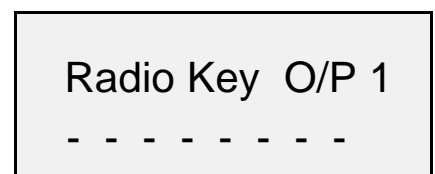

TEMPORARY OUTPUT DISABLE

This address P109E allows a technician to select any output/s to be temporarily disabled for one alarm or armed cycle, eg by turning on LEDS 1-4 at P109E then leaving program mode, outputs 1-4 will not turn on following any alarms. The technician is now free to arm the system to test all monitoring signals without having all of the internal & external alarms activating. When the alarm is reset or disarmed all outputs will now work normally again.

P109E Select output # 1-8

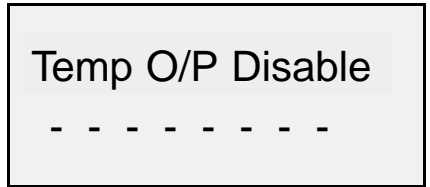

PARTITION "A" OPTIONS

PARTITION "A" OPTIONS - P110E

This address allows modification of how Partition "A" arming, STAY and control keys work at the keypad.

- P110E 1E** "ARM" button required before code to set- Default off
- 2E** "STAY" button required before code to turn on Stay Mode- Default off
- 3E** "CODE" required to arm- Default off
- 4E** "ARM" button can disarm system during exit delay - Default **on**
- 5E** "STAY" button can disarm Stay Mode at any time- Default **on**
- 6E** No Exit Beeps to keypads in Stay Mode- Default off
- 7E** Key-switch Enabled- Default off
- 8E** Key-switch Mode- Default off

- Option 1 **"ARM" button required before code to set** - This option determines if the "ARM" button must be pressed before a code is entered to set Area "A". If a keypad is assigned to both Partitions, this option should be set to allow individual arming of each area. This option disables the Arm button from disarming during the exit delay.
- Option 2 **"STAY" button required before code to set** - This option determines if the "STAY" button must be pressed before a code is entered to set Area "A" Stay Mode. If a keypad is assigned to both Partitions, this option should be set to allow individual arming of Stay Mode for each area.
- Option 3 **"CODE" required to set** - If this option is set, the "ARM" button is disabled and the panel requires a code to arm as well as disarm.
- Option 4 **"ARM" button can disarm during exit delay** - If this option is on then the "arm" button can disarm Partition "A" during the exit delay time with a single press of the button. If the option is off then the alarm can only be unset by a valid code, even during the exit delay time.
- Option 5 **"STAY" button can disarm Stay Mode** - This option allows the "Stay" button to disarm STAY mode at any time (including when Stay Mode is fully set). If the option is off then Stay Mode can only be unset by a valid code. This feature is defaulted to keypad addresses 1 & 4 (4 being the default address for the STAY key station).
- Option 6 **No Exit Beeps to keypads in Stay Mode** - This option stops the exit beeps from occurring at all keypads when Stay Mode is set. Normally used for silent night arming.
- Option 7 **Enable Partition "A" Key-switch** - If this option is turned on then the system tamper input (Tmp) becomes a Dual End of Line Input (Refer to Type 4 drawing on Page 4 for wiring details). The low input 4K7 is reserved for Partition "A" key-switch operation. An open circuit will still be seen as a system tamper.
- Option 8 **Key-switch Mode** - If this option is On then the key-switch has a toggle function (ie the arm/disarm state will follow the key-switch state). If Off then the key-switch is momentary (ie each single pulse will change the arm/disarm state). The panel tamper input is used to provide the key-switch function.

Area A Option
- - - 4 5 - - -

PARTITION "A" OUTPUT OPTIONS

PARTITION "A" OUTPUT OPTIONS - P111E - P118E

This block of addresses sets a number of output options which are specific and unique to the operation of partition or Area "A". Activity in Areas "B" will have no direct effect on the options set at these addresses.

AreaA Opt O/P 1
- - - - -

- P111E 1E** Arm status to output- Default off (**P113E=ON**)
- 2E** Stay Mode on status to output- Default off (**P113E=ON**)
- 3E** Disarm status to output- Default off (P113E=)
- 4E** Pendant chirps for Arm to output - Default off
- 5E** Pendant chirps for Stay Mode On to output - Default off
- 6E** Pendant chirps for Disarm to output - Default off
- 7E** Pulse on Arming to output - Default off (**P114E=ON**)
- 8E** Pulse on Disarming to output - Default off

- Option 1 **Arm indication to output** - This option will turn the output on when Area "A" is armed. The output will turn on at the start of the exit delay and turn off when the Area is disarmed. The output reset time should be set to zero.
- Option 2 **Stay Mode On indication to output** - This option will turn the output on when Area "A" Stay Mode is armed. The output will turn on at the start of the exit delay and turn off when Stay Mode is disarmed. The output reset time should be set to zero.
- Option 3 **Disarm indication to output** - This option will turn the output on when Area "A" is Disarmed. The output will turn on when the Area "A" is disarmed and turn off when the Area is Armed or in Stay Mode. The output reset time should be set to zero.
- Option 4 **Pendant Chirps for Arm to output** - This option will map two short pulses (Chirps) to the output when Area "A" is armed via a radio key (Pendant) ,(the length of the pulses is set by the pulse timer P221E-P228E).
- Option 5 **Pendant Chirps for Stay Mode On to output** - This option will map two short pulses (Chirps) to the output when Area "A" Stay Mode is set via a radio key (Pendant) ,(the length of the pulses is set by the pulse timer P221E -P228E).
- Option 6 **Pendant Chirps for Disarm to output** - This option will map four short pulses (Chirps) to the output when Area "A" is Disarmed via a radio key (Pendant) ,(the length of the pulses is set by the pulse timer P221E-P228E).
- Option 7 **Pulse on Arming to output** - This option will map a pulse to the Output each time Area"A" is armed (the length of the pulses is set by the pulse timer P221E-P228E).
- Option 8 **Pulse on Disarming to output** - This option will map a pulse to the Output each time Area"A" is disarmed (the length of the pulses is set by the pulse timer P221E -P228E).

Note: P112E through P118E are as above but applied to outputs 2-8

PARTITION "B" OPTIONS

PARTITION "B" OPTIONS - P120E

This address allows modification of how Partition "B" arming, STAY and control keys work at the keypad.

P120E	1E	"ARM" button required before code to set- Default off
	2E	"STAY" button required before code to turn on Stay Mode- Default off
	3E	"CODE" required to arm- Default off
	4E	"ARM" button can disarm system during exit delay - Default on
	5E	"STAY" button can disarm Stay Mode at any time- Default on
	6E	No Exit Beeps to keypads in Stay Mode- Default off
	7E	Key-switch Enabled- Default off
	8E	Key-switch Mode- Default off

AreaB Option

- - - 4 5 - - -

- Option 1 **"ARM" button required before code to set** - This option determines if the "ARM" button must be pressed before a code is entered to set Area "B". If a keypad is assigned to both Partitions, this option should be set to allow individual arming of each area. This option disables the Arm button from disarming during the exit delay.
- Option 2 **"STAY" button required before code to set** - This option determines if the "STAY" button must be pressed before a code is entered to set Area "B" Stay Mode. If a keypad is assigned to both Partitions, this option should be set to allow individual arming of Stay Mode for each area.
- Option 3 **"CODE" required to set** - If this option is set, the "ARM" button is disabled and the panel requires a code to arm as well as disarm.
- Option 4 **"ARM" button can disarm during exit delay** - If this option is on then the "arm" button can disarm Partition "B" during the exit delay time with a single press of the button. If the option is off then the alarm can only be unset by a valid code, even during the exit delay time.
- Option 5 **"STAY" button can disarm Stay Mode** - This option allows the "Stay" button to disarm STAY mode at any time (including when Stay Mode is fully set). If the option is off then Stay Mode can only be unset by a valid code. This feature is defaulted to keypad addresses 1 & 4 (4 being the default address for the STAY key station).
- Option 6 **No Exit Beeps to keypads in Stay Mode** - This option stops the exit beeps from occurring at all keypads when Stay Mode is set. Normally used for silent night arming.
- Option 7 **Enable Partition "B" Key-switch** - If this option is turned on then the system tamper input (Tmp) becomes a Dual End of Line Input (Refer to Type 4 drawing on Page 4 for wiring details). The high input 8K2 is reserved for Partition "B" key-switch operation. An open circuit will still be seen as a system tamper.
- Option 8 **Key-switch Mode** - If this option is On then the key-switch has a toggle function (ie the arm/disarm state will follow the key-switch state). If Off then the key-switch is momentary (ie each single pulse will change the arm/disarm state). The panel tamper input is used to provide the key-switch function.

PARTITION "B" OUTPUT OPTIONS

PARTITION "B" OUTPUT OPTIONS - P121E - P128E

This block of addresses sets a number of output options which are specific and unique to the operation of partition or Area "B". Activity in Areas "A" will have no direct effect on the options set at these addresses.

P121E	1E	Arm status to output- Default off
	2E	Stay Mode on status to output- Default off
	3E	Disarm status to output - Default off

- 4E Pendant chirps for Arm to output - Default off
- 5E Pendant chirps for Stay Mode On to output - Default off
- 6E Pendant chirps for Disarm to output - Default off
- 7E Pulse on Arming to output - Default off (P124=ON)
- 8E Pulse on Disarming to output - Default off

- Option 1 **Arm indication to output** - This option will turn the output on when Area "B" is armed. The output will turn on at the start of the exit delay and turn off when the Area is disarmed. The output reset time should be set to zero.
- Option 2 **Stay Mode On indication to output** - This option will turn the output on when Area "B" Stay Mode is armed. The output will turn on at the start of the exit delay and turn off when Stay Mode is disarmed. The output reset time should be set to zero.
- Option 3 **Disarm indication to output** - This option will turn the output on when Area "B" is Disarmed. The output will turn on when the Area "B" is disarmed and turn off when the Area is Armed or in Stay Mode. The output reset time should be set to zero.
- Option 4 **Pendant Chirps for Arm to output** - This option will map two short pulses (Chirps) to the output when Area "B" is armed via a radio key (Pendant) ,(the length of the pulses is set by the pulse timer P221E-P228E).
- Option 5 **Pendant Chirps for Stay Mode On to output** - This option will map two short pulses (Chirps) to the output when Area "B" Stay Mode is set via a radio key (Pendant) ,(the length of the pulses is set by the pulse timer P221E -P228E).
- Option 6 **Pendant Chirps for Disarm to output** - This option will map four short pulses (Chirps) to the output when Area "B" is Disarmed via a radio key (Pendant) ,(the length of the pulses is set by the pulse timer P221E-P228E).
- Option 7 **Pulse on Arming to output** - This option will map a pulse to the Output each time Area "B" is armed (the length of the pulses is set by the pulse timer P221E-P228E).
- Option 8 **Pulse on Disarming to output** - This option will map a pulse to the Output each time Area "B" is disarmed (the length of the pulses is set by the pulse timer P221E -P228E).

Note: P122E through P128E are as above but applied to outputs 2-8

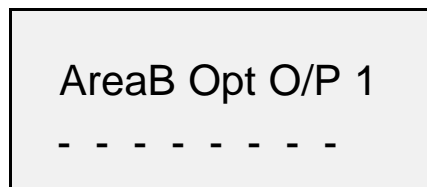

PROGRAMMING ZONE EOL OPTIONS

SINGLE ZONE EOL OR DUAL ZONE INPUT (4 or 8 zones) - P130E - Default=1-8 OFF

- P130E 1-8E Single Zone EOL or dual zone input** - This option is used to define the PW-8 as a 4 zone panel with or without EOL (End of Line Resistors) or an 8 zone panel. Options 1-4 relate to zones 1-4 respectively and decide whether the zone input requires an end of line resistor or just a short or open circuit to seal the zone. If the LED's are **OFF** (Type 1 Drawing on Page 4) then a short on the input is all that is needed to seal the input. If the LED's 1-4 are **ON** (Type 2 Drawing on Page 4) then the input requires a 2k2 resistor to seal the zone. Options 5-8 relate to zone inputs 1-4 respectively and allow "Zone Doubling" to be turned on for a particular input. When a zone has been assigned "Zone Doubling" the one input is used for both a low (1-4) and a high (5-8) zone. When zone doubling is turned On, zone 1 input is used for zones 1 & 5, zone 2 input is used for zones 2 & 6, zones 3 input is used for zones 3 & 7 and zone 4 input is used for zones 4 & 8. Zone doubling is assigned on a zone-by-zone basis. Each input can be configured as two zones (Type 3 drawing on page 4) without tamper monitoring or two zones (Type 4 drawing on page 4) with tamper monitoring. To use the Type 3 mode for zones 1 & 5

you must turn LED#1 Off and LED#5 On. To use Type 4 mode for zones 1 & 5 you must turn LED#1 On and LED#5 On. The same applies to the other zone inputs. Refer to the table on Page 4 for more details.

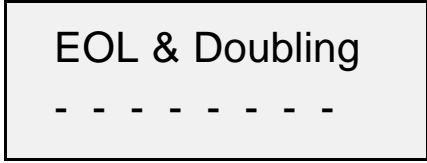

PROGRAMMING ZONE OPTIONS

PROGRAMMING ZONE OPTIONS— P129E,P131E-P150E

This block of addresses (P129E - P150E) are used to select the desired functions for Zones 1-8

P131E Partition “A” Zones Zones 1-8. (Default = **All 8 zones**)
This option allows programming of which zones will be assigned to Partition A. If a zone is in Both A & B then it becomes common to both Areas.

P132E Partition “B” Zones Zones 1-8. (Default = No zones)
This option allows programming of which zones will be assigned to Partition B. If a zone is in Both A & B then it becomes common to both Areas.

P133E Zone is NC or NO Zones 1-8. (Default =Led Off, All Zones NC, Normally Closed)

By turning the LED on for zone 1 at this address, the panel is now looking for a Normally Open (NO) contact on the zone (4K7).

P134E Radio Zone Input Zones 1-8. (Default = No zones)
This option allows programming of which zones will be radio zones. If a zone is a radio zone, the panel ignores the state of the hardwired input for that zone). If the zone input has been set to tamper monitoring , the tampers are still active even if zones are set for Radio operation.

P135E Manually BYPASSED Zone Zones 1-8. (Default = **All 8 zones**)
This option allows programming of which zones can be manually BYPASSED prior to Arming. If a zone has this option turned off, then that zone cannot be BYPASSED manually). Zones are BYPASSED during the disarm state and normal zones which are BYPASSED become re-included once the alarm has been set then unset. 24 hour zones, however remain BYPASSED until manually re-included again. Every time the alarm is set or unset with zones BYPASSED the keypad will respond with a long beep instead of the normal 3 short beeps to indicate that excludes are present. When excluding zones, the READY\EXCL & PROGRAM LED's are on to indicate that you have entered BYPASS mode. After BYPASSING zones the READY\BYP led will flash when all zones are sealed to indicate that zones are BYPASSED

P136E Auto-BYPASSED Zone Zones 1-8. (Default = No zones)
This option allows programming of which zones can be automatically BYPASSED at the end of the exit delay if unsealed at that time. If a zone has this option turned off, then that zone will not auto-BYPASSED and will go into alarm if not sealed.

P137E Follow/Handover Zone Zones 1-8. (Default = **only zone 2 =on**)
This option allows programming of which zones will be handover zones. If a zone is a handover zone then it's entry delay time will apply provided a non-handover zone is triggered before the handover zone. If no other entry delays are active when the handover zone is triggered, the zone will activate immediately.

P138E Two Trigger Zone Zones 1-8. (Default = No zones)
This option allows programming of which zones will require two triggers before they activate. To cause an activation a two trigger zone must alarm twice within the 2 trigger time period, P229E, or 2 two trigger zones can alarm once each within the two trigger time period before the alarm is generated. If a two trigger zone is unsealed and remains unsealed for a period longer than the two trigger time period, an alarm will also be generated.

P139E Stay Mode Zone Zones 1-8. (Default = **Zone 1**)

This option allows programming of which zones can be assigned as Stay Mode Zones. Only zones programmed at this address will be active when STAY mode is armed.

P129E 24 Hour Fire Zone Zones 1-8. (Default = No zones)

This option allows a zone to be programmed as a 24 hour fire zone. If programmed as a fire zone, when the zone causes an alarm it will flash any outputs it is programmed to operate at a rate set by the pulse timer (P221-228E).

P140E 24 Hour Zone Zones 1-8. (Default = No zones)

This option allows programming of which zones can be assigned as 24 Hour Zones. Only zones programmed at this address will be active at all times. If a 24 hour zone has an entry delay assigned to it, the entry delay acts as an abort timer e.g. the zone must be in alarm longer than the entry delay time before the alarm is activated. If the zone is sealed before the entry delay expires, no alarm is generated.

P141E Non-Latching 24 Hour Zone Zones 1-8. (Default = No zones)

This option allows programming of which zones can be assigned as Non-Latching 24 Hour Zones. A Non-Latching 24 Hour Zone will operate as a normal 24 Hour zone except that when the zone re-seals the zone LED and any assigned outputs will reset automatically.

P142E Lockout Zone Zones 1-8. (Default = No zones)

This option allows programming of which zones can be assigned as Lockout Zones. A Lockout Zone will only cause the alarm output to sound once during an armed period. If the lockout function is not programmed then the zone can cause the audible alarms to sound on every zone alarm. In the case of a 24 hour zone, if this option is turned on then the zone will only activate the alarm output/s once and must be reset by a code before another alarm signal can operate the output/s again.

P143E Day Zone (CHIME) when Disarmed Zones 1-8. (Default = No zones)

This option allows programming of which zones can be assigned as Day Zones. A Day Zone can be used as a door minder in a shop to warn when a customer has entered the premises. A day zone has the day zone function when the alarm is disarmed, but becomes a normal security zone when armed. Day zones can be temporarily disabled with the "Control" button if programmed to do so.

P144E Permanent Day Zone (CHIME) Zones 1-8. (Default = No zones)

This option allows programming of which zones can be assigned as Permanent Day Zones. A Permanent Day Zone can be used as a door minder in a shop to warn when a customer has entered the premises. A Permanent day zone will never cause an activation when the alarm is armed. Day zones can be temporarily disabled with the "Control" button if programmed to do so.

P145E Can Arm if not Sealed Zones 1-8. (Default = No zones)

This option allows programming of which zones can be unsealed and still allow the panel to arm. Option 4 at P170E must be on before this address has any effect. This option allows setting of the panel if low security areas are not sealed at the time of arming.

P146E Report BYPASS to Dialer Zones 1-8. (Default = All zones)

If this option is on then the zone will report any exclusion (Bypass) of the zone to a Monitoring Station via Contact ID or 4 + 2.

P147E Send Multiple Alarms to Dialer Zones 1-8. (Default = All zones)

If this option is assigned to the zone, the zone can send multiple activation reports to a monitoring company during any armed cycle. If off, the zone can only send one activation per armed cycle. In the case of a 24 hour zone, if this option is turned off then the zone will only send one signal via the dialer and must be reset by a code before another signal can be sent.

P148E Report Zone Tamper to Dialer Zones 1-8. (Default = All zones)

This option allows the programming of zone tamper to be sent via the dialer to a Monitoring Station.

P149E Zone Reports Area "B" Account Zones 1-8. (Default = No zones)

When a zone is in both partitions A&B this address allows the option of specifying which account number a zone alarm will report to. The default is that a common zone will report to area A account code (P332E) but if this option is on for a common zone it will report to area B account code (P333E).

P150E Inactivity Timer Zones Zones 1-8. (Default = None)

This option allows the programming of which zones will be monitored for inactivity. All zones programmed with this feature ON will be monitored for activity for the period set below (P240E). The inactivity timer only works

during the disarmed state and is accumulative, which means that if a zone does not trip at least once during a disarm period the inactivity timer is not reset for that zone and will continue with the balance of the time period left when the panel is next disarmed. The timer for each zone is reset every time a zone unseals.

PROGRAMMING ZONE INACTIVITY TIMER

P240E Inactivity Timer - 0-255 Hours. **Default =120 Hours**

Inactivity Timer
120

PROGRAMMING ENTRY DELAYS

P301E Zone 1 Entry Delay Time - 0-9999 Seconds (Default = **20 Sec**)
P302E Zone 2 Entry Delay Time - 0-9999 Seconds (Default = **20 Sec**)
P303E Zone 3 Entry Delay Time - 0-9999 Seconds (Default = 0 Sec)
P304E Zone 4 Entry Delay Time - 0-9999 Seconds (Default = 0 Sec)
P305E Zone 5 Entry Delay Time - 0-9999 Seconds (Default = 0 Sec)
P306E Zone 6 Entry Delay Time - 0-9999 Seconds (Default = 0 Sec)
P307E Zone 7 Entry Delay Time - 0-9999 Seconds (Default = 0 Sec)
P308E Zone 8 Entry Delay Time - 0-9999 Seconds (Default = 0 Sec)

Zone 1 Entry De-
20

PROGRAMMING EXIT DELAYS

P219E Partition "A" Exit Delay Time - 0-255 Seconds (Default = **60 Sec**)
P220E Partition "B" Exit Delay Time - 0-255 Seconds (Default = **60 Sec**)

Area A Exit Delay
60

PROGRAMMING TWO TRIGGER TIMER

P229E Two Trigger Timer - 0-255 Seconds (Default = **60 Sec**)

Two Trigger Timer
60

DAY MODE TO KEYPAD BUZZER TIMER

These addresses can be programmed to have a value from 0 to 99 but the value is in 1/10 of a second increments. This means the default of 20 at addresses P209E & P210E is equal to 2 seconds. This gives a much greater control on the duration of the day zone beep to the keypad.

P209E Area "A" Day Mode to Keypad Buzzer Timer - 0-99 (Default = 20 1/10th sec)
P210E Area "B" Day Mode to Keypad Buzzer Timer - 0-99 (Default = 20 1/10th sec)

AreaA Chime time
20

OUTPUT TIMING OPTIONS

OUTPUT RESET TIME-P311E-P318E (0-9999 Seconds)

The output reset time is how long an output will stay on following an alarm condition. A value of "0" means the output will latch until reset by a valid user code.

P311E Output 1 Alarm Reset Time - (Default = 300 Sec)
P312E Output 2 Alarm Reset Time - (Default = 300 Sec)
P313E Output 3 Alarm Reset Time - (Default = 0 Sec)
P314E Output 4 Alarm Reset Time - (Default = 0 Sec)
P315E Output 5 Alarm Reset Time - (Default = 0 Sec)
P316E Output 6 Alarm Reset Time - (Default = 0 Sec)
P317E Output 7 Alarm Reset Time - (Default = 0 Sec)
P318E Output 8 Alarm Reset Time - (Default = 0 Sec)

O/P 1 Reset Time
300

OUTPUT DELAY ON TIME-P201E-P208E (0-99 Seconds)

The output delay ON time is how long an output will be delayed before turning on following an alarm condition.

P201E Output 1 Delay On Time - (Default = 0 Sec)
P202E Output 2 Delay On Time - (Default = 0 Sec)
P203E Output 3 Delay On Time - (Default = 0 Sec)
P204E Output 4 Delay On Time - (Default = 0 Sec)
P205E Output 5 Delay On Time - (Default = 0 Sec)
P206E Output 6 Delay On Time - (Default = 0 Sec)
P207E Output 7 Delay On Time - (Default = 0 Sec)
P208E Output 8 Delay On Time - (Default = 0 Sec)

O/P 1 Delay Time
0

OUTPUT DAY MODE TIME-P211E-P218E (0-99 1/10th Second)

The output day mode timer is how long an output will turn on following a day zone unsealing. The Day Mode Timer is in 1/10th Sec intervals e.g. 20=2 Seconds

P211E Output 1 Day Mode Time - (Default = 20)
P212E Output 2 Day Mode Time - (Default = 20)
P213E Output 3 Day Mode Time - (Default = 20)
P214E Output 4 Day Mode Time - (Default = 20)
P215E Output 5 Day Mode Time - (Default = 20)
P216E Output 6 Day Mode Time - (Default = 20)
P217E Output 7 Day Mode Time - (Default = 20)
P218E Output 8 Day Mode Time - (Default = 20)

O/P 1 Chime Time
20

OUTPUT PULSE TIMER-P221E-P228E (0-99 1/10th Second)

The output pulse timer is how long an output will turn on when the pulse timer is used. The Pulse Timer is in 1/10th Sec intervals e.g. 20=2 Seconds

P221E Output 1 Pulse Timer - (Default = 20)
P222E Output 2 Pulse Timer - (Default = 20)
P223E Output 3 Pulse Timer - (Default = 20)
P224E Output 4 Pulse Timer - (Default = 20)
P225E Output 5 Pulse Timer - (Default = 20)
P226E Output 6 Pulse Timer - (Default = 20)
P227E Output 7 Pulse Timer - (Default = 20)
P228E Output 8 Pulse Timer - (Default = 20)

O/P 1 Pulse Time
20

ENROLLING RADIO ZONE (CODE LOAD)

To load a radio device as a zone input on the panel, press the appropriate address number (eg P604E for Zone 4). The keypad buzzer will beep once a second to indicate learn mode has been initiated and the Led on the RX-40 board will flash. The radio device you wish to load must transmit a signal within 30 seconds of entering learn mode otherwise the panel will time out and no code will be loaded. If a valid code is received within the 30 seconds the keypad will give 3 short beeps and exit learn mode. To remove a loaded radio code at a single address only, enter in the address you wish to delete the code at eg P604E, then without operating the transmitter and before the 30 second timer expires press the "Enter" button. This will remove the code loaded against this address (in this case radio zone 4).

P601E	Load Radio Code for Zone 1
P602E	Load Radio Code for Zone 2
P603E	Load Radio Code for Zone 3
P604E	Load Radio Code for Zone 4
P605E	Load Radio Code for Zone 5
P606E	Load Radio Code for Zone 6
P607E	Load Radio Code for Zone 7
P608E	Load Radio Code for Zone 8

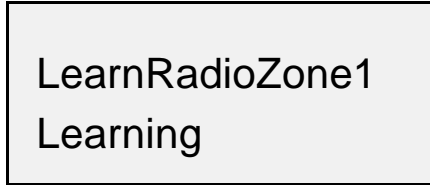

RADIO ZONE DETECTOR OPTIONS

RADIO ZONE DETECTOR OPTIONS- P231E-P238E - Default= 0

This block of addresses (P231E - P238E) are used to select the type of detector to be used on the radio zone input and allow functions such as battery low, tamper and normal alarm to be correctly recognized. To make the radio zone work you must also tell the zone input that it is a radio zone (P134E-zones 1-8).

P231E-Zone 1 Options 1E	Crow AE series battery Low
2E	Crow AE series Radio Reed Switch
3E	Crow Merlin PIR (supervised signal ignored)
4E	Crow Merlin PIR (supervised signal active)
5E	Freelink with checksum (supervised signal active)
6E	Freelink with checksum (Non-supervised)
11E	Ness Radio devices Battery Low
12E	Ness Radio Reed Switch
21E	Electronics Line Cougar Radio PIR
31E	Visonic K900 Radio PIR
32E	Visonic Powercode Devices (supervised signal ignored)
33E	Visonic Powercode Devices (supervised signal active)

- Option 5 **Freelink with checksum (supervised signal active)** - If a Crow Freelink radio PIR is used on the Alert radio zone input, setting this bit allows the panel to correctly recognize the alarm, tamper & battery low signal from the device. The automatic supervised signal is sent every 20 minutes.
- Option 6 **Freelink with checksum (non-supervised)** - If a Crow Freelink radio PIR is used on the Alert radio zone input, setting this bit allows the panel to correctly recognize the alarm, tamper & battery low signal from the device. The automatic supervised signal sent every 20 minutes by the PIR is ignored in this mode.
- Option 1 **Crow AE Series Battery Low** - If a Crow (AE) radio pendant or PIR is used on the PW-8 radio zone input, setting this bit allows the panel to correctly recognize the battery low signal from Crow devices.
- Option 2 **Crow AE Series Radio Reed Switch** - If a Crow (AE) radio reed switch is used on the PW-8 radio zone input, setting this bit allows the panel to correctly recognize the battery low signal from the Crow device. This bit also recognizes the open and closed signals from the reed switch so the zone Led can follow the correct state of the reed switch (i.e. open or closed)
- Option 3 **Crow Merlin PIR (unsupervised)** - If a Crow Merlin radio PIR is used on the PW-8 radio zone input, setting this bit allows the panel to correctly recognize the alarm, tamper & battery low signal from the device. The automatic supervised signal sent every 40 minutes by the PIR is ignored in this mode.
- Option 4 **Crow Merlin PIR (supervised)** - If a Crow Merlin radio PIR is used on the PW-8 radio zone input, setting this bit allows the panel to correctly recognize the alarm, tamper & battery low signal from the device. Setting this option on also starts a 4 hour timer for the supervised signal. The 4 hour timer is

constantly being reset while valid supervised signals are being received every 40 minutes. If no supervised signals are received from the PIR within the 4 hour period, a supervised alarm is generated.

- Option 11 **Ness Battery Low** - If a Ness radio pendant or PIR is used on the PW-8 radio zone input, setting this bit allows the panel to correctly recognize the battery low signal from Ness devices.
- Option 12 **Ness Radio Reed Switch** - If a Ness radio reed switch is used on the PW-8 radio zone input, setting this bit allows the panel to correctly recognize the battery low signal from Ness device. This bit also recognizes the open and closed signals from the reed switch so the zone Led can follow the correct state of the reed switch (ie open or closed)
- Option 21 **Electronics Line Radio PIR-** If an Electronics Line radio PIR is used on the PW-8 radio zone input, setting this bit allows the panel to correctly recognize the alarm, tamper & battery low signal from EL device.
- Option 31 **Visonic Radio PIR-** If a Visonic K900 radio PIR is used on the PW-8 radio zone input, setting this bit allows the panel to correctly recognize the alarm, tamper & battery low signal from the device.
- Option 32 **Visonic Powercode (unsupervised)** - If a Visonic Powercode radio device is used on the PW-8 radio zone input, setting this bit allows the panel to correctly recognize the alarm and battery low signal from the device but the supervised signal is ignored.
- Option 33 **Visonic Powercode (supervised)** - If the Visonic Powercode range of radio PIR or reed switch are used on the PW-8 radio zone input, setting this bit allows the panel to correctly recognize the alarm, tamper & battery low signal from the device. Setting this option on also starts a 4 hour timer for the supervised signal. The 4 hour timer is constantly being reset while valid supervised signals are being received every 1-1.5 hours. If no supervised signals are received from the PIR within the 4 hour period, a supervised alarm is generated.

Note: P232E through P238E are as above but applied to zones 2-8

Radio Zone 1 Type

5

RADIO ZONE SUPERVISED TIMER

P239E RADIO ZONE SUPERVISED TIMER - Default= 240 Minutes (Value 0-255 Minutes)

ENROLLING RADIO KEYS

To load a radio pendant on the panel, press the appropriate address number (e.g. P614E for Pendant 4). The keypad buzzer will beep once a second to indicate learn mode has been initiated and the Led on the RX-40 board will flash. The radio pendant you wish to load must transmit a signal within 30 seconds of entering learn mode otherwise the panel will time out and no code will be loaded. If a valid code is received within the 30 seconds the keypad will give 3 short beeps and exit learn mode. To remove a loaded radio pendant at a single address only, enter in the code load address as above eg P614E, then without operating the transmitter and before the 30 second timer expires press the "Enter" button. This will remove the code loaded against this address (in this case radio pendant 4).

- P611E Load Radio Pendant # 1**
- P612E Load Radio Pendant # 2**
- P613E Load Radio Pendant # 3**
- P614E Load Radio Pendant # 4**
- P615E Load Radio Pendant # 5**
- P616E Load Radio Pendant # 6**
- P617E Load Radio Pendant # 7**
- P618E Load Radio Pendant # 8**

Learn Pendant 1
Learning

RADIO PENDANT OPTIONS "A"

RADIO PENDANT OPTIONS "A" - P151E-P158E

This block of addresses (P151E - P158E) are used to select the operational settings for each of the 8 radio pendants. Functions such as arm only, disarm only or both can be selected for each pendant independently.

Pendant 1 Opt A 1 - 3 4 - - - -

- | | | |
|---------------------------------|-----------|---|
| P151E-Pendant #1 Options | 1E | Assigned to Partition "A" - Default on |
| | 2E | Assigned to Partition "B" - Default off |
| | 3E | Pendant can Arm the system - Default on |
| | 4E | Pendant can Disarm the system - Default on |
| | 5E | Pendant can turn Stay Mode On - Default off |
| | 6E | Pendant can turn Stay Mode Off - Default off |
| | 7E | Spare - Default off |
| | 8E | Pendant is disabled if panel is in alarm - Default off |

- Option 1 **Assigned to Partition "A"** - This option assigns the pendant to partition "A". The pendant must be assigned to at least one partition to allow it to perform arm/disarm functions. The pendant can be assigned to both partitions if required.
- Option 2 **Assigned to Partition "B"** - This option assigns the pendant to partition "B". The pendant must be assigned to at least one partition to allow it to perform arm/disarm functions. The pendant can be assigned to both partitions if required.
- Option 3 **Pendant can Arm** - This option assigns the Arm function to a pendant. The partition/s it will arm has to be selected at options 1 & 2.
- Option 4 **Pendant can Disarm** - This option assigns the Disarm function to a pendant. The partition/s it will disarm has to be selected at options 1 & 2.
- Option 5 **Pendant can turn Stay Mode On** - This option assigns the Stay Mode Arm function to a pendant. The partition/s it will arm has to be selected at options 1 & 2. If Stay Mode arming is to be used for this pendant then Options 2 & 3 should be turned off.
- Option 6 **Pendant can turn Stay Mode Off** - This option assigns the Stay Mode Disarm function to a pendant. The partition/s it will disarm has to be selected at options 1 & 2. If Stay Mode disarming is to be used for this pendant then Options 2 & 3 should be turned off.
- Option 7 **Spare**
- Option 8 **Pendant Disabled if panel is in Alarm** - This option stops the pendant from working while the panel is in alarm. This feature should only be set if you feel that a pendant with disarming functions could be prone to misuse in an alarm condition.

Note: P152E through P158E are as above but applied to pendants 2-8

RADIO PENDANT OPTIONS "B"

RADIO PENDANT OPTIONS "B" - P161E-P168E

This block of addresses (P161E - P168E) are used to select output control and Panic options for each of the 8 radio pendants. To prevent confusion, if a pendant is set to control an output or provide instant Panic, then you should turn off any Arm or Disarm options at addresses P151E-P158E.

Pendant 1 Opt B - - - - -

- | | | |
|---------------------------------|-----------|--|
| P161E-Pendant #1 Options | 1E | Turn output ON - Default off |
| | 2E | Turn output OFF - Default off |
| | 3E | Visonic Powercode Battery Low - Default off |

- 4E Spare - Default off
- 5E Report Pendant Panic To Dialer - Default off
- 6E Immediate Panic Alarm - Default off
- 7E Delayed Panic Alarm (1.5 Seconds) - Default off
- 8E Ness Battery Low - Default off

- Option 1 **Turn Output On** - This option allows the pendant to turn an output on. The output the pendant will turn On is programmed at address P101E-P108E. If the output reset time is set to Latched operation (set to "0") then you must also program Option 2 to the pendant to allow for turning the output Off.
- Option 2 **Turn Output Off** - This option allows the pendant to turn an output off. The output the pendant will turn Off is programmed at address P101E-P108E. For this option to work, option 1 above must also be assigned to the pendant to allow the pendant to first turn the output on before it can turn it off.
- Option 3 **Visonic Powercode Battery Low** - If a Visonic Powercode Transmitter with battery low monitoring is used on the PW-8, setting this option will allow the battery signal to be correctly recognised.
- Option 4 **Spare**
- Option 5 **Report Panic to Dialer**- This option enables a panic alarm from a pendant to be sent via the dialer to a Monitoring Station.
- Option 6 **Immediate Panic Alarm** - If this option is on, pressing the pendant button will produce a pendant panic alarm. The Panic alarm can also be silent at the keypad or sound the keypad buzzer (see P175E)
- Option 7 **Delayed Panic Alarm**- If this option is on, the pendant button must be pressed continuously for 1.5 seconds or longer to produce a pendant panic alarm.
- Option 8 **Ness Battery Low** - If using a Ness pendant with battery low reporting, this option must be turned on to allow the battery low signal to be recognized properly.,

Note: P162E through P168E are as above but applied to pendants 2-8

KEYPAD PARTITION ASSIGNMENT

A keypad must be assigned to a Partition before it can control the Partition (ie to allow Arm/Disarm facilities).

- P171E **Keypads Assigned to Partition "A"** - Option Keypad 1-8 (Default = All keypads 1-8)
- P172E **Keypads Assigned to Partition "B"** - Option keypad 1-8 (Default = None)

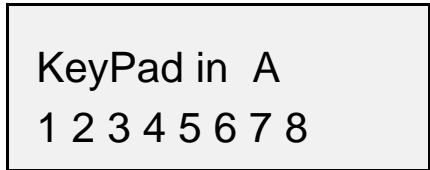

KEYPADS WITH PANIC BUTTON ENABLED

The panic button on all keypads can be set for delayed or instant operation. If you do not want the Panic function enabled at any of the keypads you can dsable the operation at this address. This option may be useful where a keypad has to be installed in a public area.

- P173E **Keypads with the Panic Button Enabled** - Option keypad 1-8 (Default = All keypads 1-8)

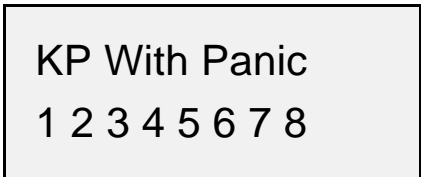

KEYPADS PANIC (1&3)OR (CHIME&CONTROL) ENABLED

An alternative Panic function to the dedicated panic button is to press the keypad buttons 1&3 simultaneously. If you do not want this Panic function enabled at any of the keypads you can disable the operation at this address. This option may be useful where a keypad has to be installed in a public area.

P174E Keypads with the Panic Buttons 1&3 or CHIME&CONTROL Enabled - Option keypad 1-8 (Default = None)

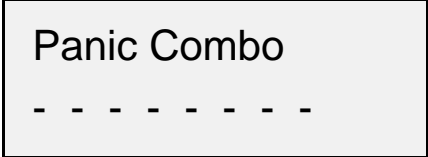

KEYPAD & RADIO PANIC ALARM TO KEYPAD BUZZER

The two Keypad panic functions (P173E or P174E) plus the Radio Panic Alarms can be audible or silent at the keypads. If a silent panic is required the option must be turned off at this address. For an audible Panic Beep at the keypad/s turn this option on.

P175E Keypad & Radio Panic Alarm to Keypad Buzzer - Option keypad 1-8 (Default = All keypads 1-8)

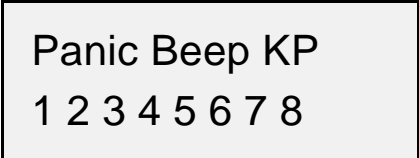

KEYPADS FIRE (4&6) OR (CHIME&B) ENABLED

By pressing the buttons 4&6 or CHIME&B simultaneously it is possible to create a Fire alarm report to the dialer. If you want this Fire function enabled at any of the keypads you must enable the operation at this address.

P176E Keypads with the Panic Buttons 4&6 or CHIME&B Enabled - Option keypad 1-8 (Default = None)

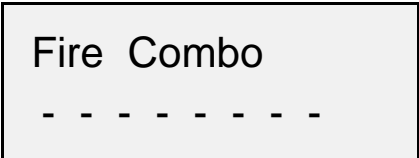

FIRE ALARM TO KEYPAD BUZZER

The two button fire function at the keypads (P176E) can be audible or silent at the keypads. If a silent fire alarm is required the option must be turned off at this address. For an audible Panic Beep at the keypad/s turn this option on.

**P177E Fire Alarm to Keypad Buzzer
Option keypad 1-8 (Default = None)**

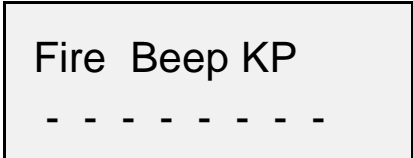

KEYPADS MEDICAL (7&9) OR (B&A) ENABLED

By pressing the buttons 7&9 or B&A simultaneously it is possible to create a Medical alarm report to the dialer. If you want this Medical function enabled at any of the keypads you must enable the operation at this address.

P178E **Keypads with the Medical Buttons 7&9 or B&A Enabled** - Option keypad 1-8 (Default = None)

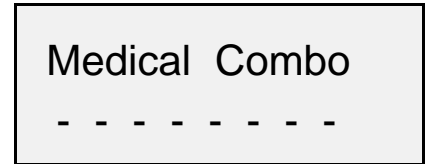

MEDICAL ALARM TO KEYPAD BUZZER

The two button medical function at the keypads (P178E) can be audible or silent at the keypads. If a silent medical alarm is required the option must be turned off at this address. For an audible Medical Beep at the keypad/s turn this option on.

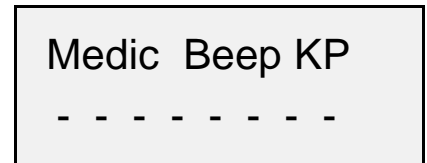

P179E **Medical Alarm to Keypad Buzzer** - Option keypad 1-8 (Default = None)

STAY BUTTON CAN DISARM STAY MODE

The Alarm panel can be set up so that the “Stay” button at the keypad can be a single press to arm Stay Mode. During the Stay Armed state the “Stay” button can also be used to Disarm Stay Mode with a single press provided the keypad concerned has this option turned on. If you do not want single button disarming of STAY mode at any keypads then ensure this option is off for the keypad/s concerned. *Also, after Stay Mode has been armed, if the “Enter” button is pressed, all exit & entry delays will be removed making the whole alarm instant. If the “Enter” button is not pressed then all exit and entry delays will apply.*

P180E **Stay Button can Disarm Stay Mode** - Option keypad 1-8 (Default = 1 & 4)

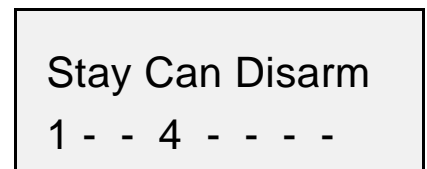

MISCELLANEOUS PANEL OPTIONS # 1

This address (P169E) is used to select the first set of optional panel functions.

- P169E 1E** Turn Off keypad LEDS at the end of exit time - Default off
- 2E** Keypad Panic Button delayed or instant - Default off
- 3E** Installer Code has direct access to Program Mode - Default **on**

Option 1 **Turn off keypad LEDS at end of exit time** - If this option is off (LED 1 Off) then the keypad LEDS remain working at all times. If it is on (LED 1 On), the keypad LEDS will automatically turn off at the end of the exit delay time (NOTE: the backlight LED’s on an LED keypad will remain on). The LEDS will turn on again if the alarm is unset, an alarm occurs or any button on the keypad is pressed.

Option 2 **Keypad Panic Button delayed or instant** - If this option is off (LED 2 Off) any press of the “Panic” button on the LED keypads will result in an immediate panic alarm. If it is turned on (LED 2 On) there will now be a 2 second delay on the panic button. The button must be held down continuously for 2 seconds to create a panic alarm.

Option 3 **Installer Code has direct access to Program Mode** - If this option is off (LED 3 Off) the installer code cannot gain direct access to installation program mode. Access to installation program mode in this case must be via Client program Mode first (the owner must give authorization to the installer). If the option is on (LED 3 On) then the installer code will allow direct access to Installation program mode provided no areas are armed or in STAY mode.

MISCELLANEOUS PANEL OPTIONS # 2

This address (P170E) is used to select the second set of optional panel functions.

P170E	1E	Panel Tamper NC or EOL - Default off
	2E	Installer Lockout - Default off
	3E	Disable Mains Fail Test - Default off
	4E	Arm only if sealed - Default on
	5E	No audible keypad beep on supervised radio fault - Default off
	6E	No audible keypad beep for zone Inactivity Timeout - Default off
	7E	“Control” button disables Day Zones(CHIME) - Default on
	8E	Silent 24 Hour Alarms (No keypad Buzzer) - Default off

- Option 1 **Panel Tamper NC or EOL** - The Tamper input on the PW-8 control board (Tmp) requires sealing to clear the panel tamper alarm. If option 1 is on the panel must see a 2k2 resistor (EOL) across the Tmp & 0V terminals to ensure the tamper is sealed. If this option is turned off the a simple short circuit (NC) is all that is required to seal the panel tamper.
- Option 2 **Installer Lockout** - Normally, if the panel is unset and powered up with the panel tamper open (in alarm) then the panel will automatically go into installer program mode. If this option is on, the panel will not automatically go into program mode and the only valid method of accessing program mode is via the installer code.
- Option 3 **Disable Mains Fail Test** - If the panel must be run off a DC supply but the supply is too low to be wired into the AC terminals then this option completely disables the mains fail monitoring so the panel will not give a continuous system alarm.
- Option 4 **Arm only if sealed** - If this option is on then the panel can only be armed if all zones are sealed(Ready LED On), with the exception of those zones which can be unsealed if programmed at address P145E.
- Option 5 **No audible keypad beep on supervised radio fault** - If a supervised radio detector fails to send a test signal within a preset period, an alarm will be generated. A supervised alarm will cause the system LED on the keypad to flash. If this option is off then all keypad buzzers will also sound continuously to warn of the problem. If this option is on, the buzzers will not sound on a supervised alarm but the system LED will still flash.
- Option 6 **No audible keypad beep on zone inactivity timeout** - If a zone is set for inactivity monitoring (P150E) and it does not unseal at least once during the timeout period (P240E) an alarm will be generated. An inactivity timeout will cause the trouble LED on the keypad to flash and the zone led that failed will be on solid. If this option is off then all keypad buzzers will also sound continuously to warn of the problem. If this option is on, the buzzers will not sound on a zone inactivity alarm but the trouble LED will still flash.
- Option 7 **“CONTROL” function disables day zones(CHIME)** - This option will disable the day zone monitoring when “Control” is on. It is used to stop day zone beeps from occurring at the keypad or operating an output when not needed. To initiate the “Control” function the operator must press The “Control” button followed by the “Program” button. When the “Control” function is On the Program LED will flash.
- Option 8 **Silent 24 Hour Alarms (No keypad Buzzer)** - If this option is on then any 24 hour alarms (P129,140 or 141E) will not cause the keypad buzzer to sound i.e. silent alarm.

DURESS DIGIT

This address (P230E) is used to program the duress digit. The duress digit is a number from 1-9 ("0" means the duress function is disabled). To create a duress alarm the duress digit must be entered before a valid user code (eg If the code was "123" and the duress number was "4", then entering a code of "4123" "Enter" would create a duress alarm).

Duress Digit

0

P230E Duress Digit - Value 1-9 (Default = 0, Disabled)

SETTING REAL TIME CLOCK

The Real Time Clock is used to Time & Date stamp the events in the Event Buffer. Ensure this is set correctly at the time of installation so that the events have the proper time and date associated with them. The clock is programmed in 24 hour format (e.g. 00:00-23:59).

P401E Real Time Clock Hour/Minute - Value 0-2359

P403E Real Time Clock Day of Week - Value 1-7 (where 1 = Sunday, 2 = Monday, 3 = Tuesday, etc)

P405E Real Time Clock Date - Value 1-31

P406E Real Time Clock Month - Value 1-12

P407E Real Time Clock Year - Value 0-99

Set Time HH:MM

18:23

(Daylight Saving settings: NOT available in V8.64 panels and above)

The real time clock can have preset automatic adjustments for the start & finish of daylight saving if applicable. If a value of "0" is entered at addresses P408 & P411 then no daylight saving adjustments will apply. Otherwise set up the parameters for the country concerned and the adjustments will become automatic every year.

P408E Daylight Saving Start Sunday - Value 0-5 - Default = 1 (0=daylight saving start time disabled)

P409E Daylight Saving Start Month - Value 1-12 - Default = 10

P410E Daylight Saving Start Hour - Value 0-23 - Default = 2

P411E Daylight Saving End Sunday - Value 0-5 - Default = 3 (0=daylight saving end time disabled)

P412E Daylight Saving End Month - Value 1-12 - Default = 3

P413E Daylight Saving End Hour - Value 0-23 - Default = 3

When setting up a panel for the first time using daylight saving, you must ascertain whether daylight saving is currently ACTIVE. If it is you must enter in P414E then 1E to tell the panel that daylight saving is ON to sync the panel to daylight saving mode. If this is not done then when daylight saving finishes the panel will not adjust the clock.

P414E Daylight Saving is Active (If LED #1 is On, Daylight Saving is currently active)

RESTORE FACTORY DEFAULTS

This address (P620E) is used to return the panel back to factory default settings.

P620E Restore Factory Defaults

Reset All

Done

RESTORING SELECTED DEFAULTS

P621E Restore User Codes to Default only.

P622E Restore all Program Addresses from 20-199 to Default

- P623E Restore all Program Addresses from 200-399 to Default
- P624E Restore all Program Addresses from 500-599 to Default
- P625E Restore all Radio & Pendant codes to Default

Reset Addr 21-199
Done

CLEAR ALARM MEMORY BUFFER

This address (P626E) is used to clear the panels alarm memory buffer.

- P626E Clear Alarm Memory Buffer

Clear Mem Buffer
Done

WALK TEST MODE

This address (P627E) is used to enable walk-test mode while in installer program mode. By pressing P627E at the keypad, the keypad buzzer will beep at 1 second intervals to indicate walk-test mode is active. By walking past all of the detectors connected to the system and activating them, the associated zone light will latch up at the keypad to allow verification that all zones are working properly. By pressing the "Program" or "Enter" buttons, walk-test mode can be terminated and normal programming resumed.

Walk Test Mode
- - - - -

All Walk test activities will go into the event memory for display via the LCD keypad or LED keypad , In memory display mode

- P627E Walk-test Mode

WRITE TO EEPROM (DTU) BOARD

This address (P628E) is used to copy the panels program configuration to an external EPROM memory card (DTU-Data Transfer Unit) which can be plugged into the expansion socket on the control board.

- P628E Write to EEPROM (DTU) Board

Write To EEPROM
Done

READ FROM EEPROM (DTU) BOARD

This address (P629E) is used to return the panels program configuration from an external EPROM memory card (DTU-Data Transfer Unit) which can be plugged into the expansion socket on the control board.

- P629E Read from EEPROM (DTU) Board

Read fromEEPROM
Done

DIALER PROGRAMMING SECTION

The Dialer section of this alarm panel has many different programmable options. Some of these options require special function keys to select or program the options when entering telephone numbers or 4+2 codes. These special function keys and their corresponding keypad LED indications are listed in the following table.

LED KEYPAD BUTTON	LED KEYPAD INDICATION	LCD KEYPAD BUTTON	4+2 FUNCTION	TELEPHONE NUMBER SPECIAL FUNCTION
"0"	ARMED A	0	"O or A"	NA
"PANIC"	READY/BYP	CONTROL & 2	"B"	"#"
"MEMORY"	SYSTEM	CONTROL & 3	"C"	"*"
"CONTROL"	TROUBLE	CONTROL & 4	"D"	"2.5 sec Pause"
"ARM"	READY/BYP SYSTEM	CONTROL & 5	"E"	"Wait for 2nd Dial-tone"
"STAY"	READY/BYP TROUBLE	CONTROL & 6	"F"	"5 sec Pause"

DIALER PROGRAMMING OPTIONS

This address (P185E) is used to turn the dialer on and select other dialer related options.

P185E	1E	Dialer is Enabled - Default on
	2E	Fax Defeat - Default on
	3E	Disable Telephone Line Monitoring - Default off
	4E	DTMF or Pulse Dialing - Default off (NOTE: Options 4 & 5 must be OFF for DTMF Dial)
	5E	DTMF or Reverse Pulse Dialing - Default off (NOTE: Options 4 & 5 must be OFF for DTMF Dial)
	6E	Spare - Default off
	7E	Auto-detect Modem - Default on
	8E	Bell 103 or V21 - Default off

- Option 1 **Dialer is Enabled** - If this option is turned off the dialer will be disabled. The option must be on to allow the dialer to make calls.
- Option 2 **Fax Defeat** - The panel can answer an in-coming call in two ways. The first is to set the auto-answer ring count to a convenient number (P249E) and let the phone ring until this number is reached at which time the panel will answer the call. The second method is to use fax defeat which entails calling the panel and letting it ring no more than 4 times, hanging up, then ringing back within 45 seconds. The panel will now answer the call on the first ring.
- Option 3 **Disable Telephone line Monitoring** - If the panel is connected to a poor telephone line and the line failure alarm is appearing regularly, by turning this option on the panel will not do the line test.
- Option 4 **DTMF or Pulse Dial** - If this option is On then the panel will dial using Normal Pulse Dialing format (eg the number 9 = 9 pulses) **NOTE: Options 4 & 5 must be OFF for DTMF Dial**
- Option 5 **DTMF or Reverse Pulse Dial** - If this option is On then the panel will dial using Reverse Pulse Dialing format (e.g. the number 9 = 1 pulse) **NOTE: Options 4 & 5 must be OFF for DTMF Dial**
- Option 6 **Spare**
- Option 7 **Auto-detect Modem** - If this option is on the panel will answer an in-coming call with the V21 acknowledge tone. If the modem does not respond within 5 seconds the panel will then generate the acknowledge tones for Bell 103 format. It will repeat this cycle twice and then hang-up if no communication with a modem is established.
- Option 8 **Bell 103 or V21** - The dial up panel to PC link can be established using either Bell 103 or V21. If the auto-detect function at option 7 does not result in the best format for your modem then you can force the panel to only communicate in one format. If the LED is off the format is Bell 103, LED on means V21.

Dialer Options

- - - - - 7 -

DIALER REPORTING OPTIONS "A"

This address (P186E) is used to enable or disable various alarm reports to the Dialer.

P186E	1E	Report Duress Alarm - Default on
	2E	Report Mains Fail - Default on
	3E	Report Battery Low - Default off
	4E	Report Radio Battery Low - Default on
	5E	Report System Tamper - Default on
	6E	Report Telephone line Failure - Default on
	7E	Report Supervised Radio Fault - Default on
	8E	Report Zone Inactivity Alarm - Default on

Dialer Report 1

1 2 - 4 5 6 7 8

- Option 1 **Duress Alarm to Dialer** - If a duress alarm is created the panel can report the unsetting of the alarm under duress to a central monitoring company if this option is on.
- Option 2 **Report Mains Fail** - If a mains failure is detected the panel can report this alarm to a central monitoring company if this option is on.
- Option 3 **Report Battery Low** - If a battery low is detected the panel can report this alarm to a central monitoring company if this option is on.
- Option 4 **Report Radio Battery Low** - If a Radio battery low is detected the panel can report this alarm to a central monitoring company if this option is on.
- Option 5 **Report System Tamper** - If a control panel tamper is detected the panel can report this alarm to a central monitoring company if this option is on.
- Option 6 **Report Line Failure** - If a telephone line failure is detected the panel can report this alarm to a central monitoring company if this option is on.
- Option 7 **Report Supervised Radio Fault** - If a supervised radio device fails to report to the panel within a preset time then a radio failure is registered. If this option is turned on then the alarm will be reported to the monitoring company.
- Option 8 **Report Zone Inactivity Alarm** - If a Zone is monitored for Inactivity (P150E) and the inactivity timer for that zone times out (P240E) an alarm will be generated. If this option is turned on then the alarm will be reported to the monitoring company.

DIALER REPORTING OPTIONS "B"

This address (P187E) is used to enable or disable various alarm reports to the Dialer.

P187E	1E	Report Keypad Panic Alarms - Default on
	2E	Report Keypad Manual Fire Alarms (4&6) - Default on
	3E	Report Keypad Manual Medical Alarms (7&9) - Default on
	4E	Spare
	5E	Spare
	6E	Spare
	7E	Spare
	8E	Spare

Dialer Report 2

1 2 3 - - - - -

- Option 1 **Report Keypad Panic Alarms** - If the single button "**Panic**" or the 2 button "**1&3**" Panic alarm features are enabled then turning this on option allows the Panic Alarm to be sent via the dialer to a monitoring

station.

- Option 2 Report Keypad Fire Alarm - If the 2 button “4&6” Fire alarm feature is enabled then turning this option on allows the Fire Alarm to be sent via the dialer to a monitoring station.
- Option 3 Report Keypad Fire Alarm - If the 2 button “4&6” Fire alarm feature is enabled then turning this option on allows the Fire Alarm to be sent via the dialer to a monitoring station.

DIALER REPORTING OPTIONS “C”

This address (P188E) is used to enable or disable various alarm reports to the Dialer.

- P188E 1E** Report Arm/Disarm - Default **on**
 - 2E** Report Stay Mode Arm/Disarm - Default **on**
 - 3E** Report Disarm only after an Activation - Default **off**
 - 4E** Report Stay Mode Disarm only after an Activation - Default **off**
 - 5E** Report 24 Hour Alarms when set to Domestic/Voice mode - Default **off**
 - 6E** Send Arm immediately - Default **off**
 - 7E** Send Zone alarms in Stay Mode - Default **off**
 - 8E** Spare - Default **off**
- Option 1 **Report Arm/Disarm** - If this option is on then all Arm/Disarm signals will be reported to a central Monitoring Station if Contact ID or 4 + 2 is set as the reporting format.
 - Option 2 **Report Stay Mode Arm/Disarm** - If this option is on then all Stay Mode Arm/Disarm signals will be reported to a central Monitoring Station if Contact ID or 4 + 2 is set as the reporting format.
 - Option 3 **Send unset after activation** - If this option is on, the panel will not normally send an Arm/Disarm signal to the monitoring company, however, if a zone alarm occurs then the panel will send a Disarm following the disarming of the panel to show it has been turned off by a valid user.
 - Option 4 **Send Stay Mode unset after activation** - If this option is on, the panel will not normally send a Stay Mode Arm/Disarm signal to the monitoring company, however, if a zone alarm occurs then the panel will send a Disarm and group bypass restore following the disarming of the panel to show it has been turned off by a valid user.
 - Option 5 **Report 24 Hour Alarms when set to Domestic/Voice mode** - When the panel is set to send alarms via domestic or voice mode, NO alarms will normally be sent for 24 hour zones. If 24 hour alarms are required to be reported in Domestic/Voice mode then this option must be turned on.
 - Option 6 **Send Arm immediately** - If this option is on, the arm report is sent immediately the panel is armed. If the option is turned off, the arm signal will be sent at the expiry of the exit delay timer.
 - Option 7 **Send Zone alarms in Stay Mode** - If this option is on, any Stay Mode zone alarms will be reported via the dialer. If it is off, no Stay Mode zone alarms will be transmitted via the dialer.

Dialer Report 3

1 2 - - - - -

KEYPAD LISTEN-IN OPTIONS

The panel provides the facilities to use the buzzer in the keypad as a speaker to listen to the call being made by the dialer. To use this feature a 5th wire must be connected between the panel and a keypad using the listen-in terminals.

- P189E 1E** Listen-in Enabled when dialing only and in Disarmed State - Default **on**
- 2E** Listen-in Enabled when dialing only and in Armed State - Default **on**
- 3E** Listen-in Enabled when dialing only and in Stay Mode - Default **on**
- 4E** Listen-in Enabled through the entire call only in Disarmed state - Default **on**

- 5E Listen-in Enabled through the entire call only in Armed State - Default on
- 6E Listen-in Enabled through the entire call only in Stay Mode - Default on
- 7E Listen-in Enabled when the panel answers a call - Default on
- 8E Listen-in on at All Times - Default off

Keypads Listen In
1 2 3 4 5 6 7 -

OUTPUT # 1 LISTEN-IN OPTIONS

The panel provides the facilities to use a horn speaker connected to Output 1 to listen to the call being made by the dialer. To use this feature a horn speaker MUST be connected to Output 1 and the output set for siren Mode (P31E Option 5).

- P190E 1E Listen-in Enabled when dialing only and in Disarmed State - Default off
- 2E Listen-in Enabled when dialing only and in Armed State - Default off
- 3E Listen-in Enabled when dialing only and in Stay Mode - Default off
- 4E Listen-in Enabled through the entire call only in Disarmed state - Default off
- 5E Listen-in Enabled through the entire call only in Armed State - Default off
- 6E Listen-in Enabled through the entire call only in Stay Mode - Default off
- 7E Listen-in Enabled when the panel answers a call - Default off
- 8E Listen-in on at All Times - Default off

O/P 1 Listen In
- - - - -

PROGRAMMING TELEPHONE NUMBERS

The panel can be programmed with up 4 telephone numbers. The numbers can be up 16 digits long. Dial modifiers such as Pause can be programmed into the number sequence as per the chart below. See the table on page 38 for more information on the special telephone number characters/modifiers.

<u>LED KEYPAD</u> BUTTON	<u>LCD KEYPAD</u> BUTTON	<u>FUNCTION TO</u> BE PROGRAMMED	<u>LED KEYPAD INDICATION</u> INDICATION
"Panic"	Control 2	#	READY/BYP
"Memory"	Control 3	*	SYSTEM
"Control"	Control 4	2.5 sec Pause	TROUBLE
"Arm"	Control 5	Wait for 2nd Dial tone	READY/BYP & SYSTEM
"Stay"	Control 6	5 sec Pause	READY/EXCL & TROUBLE

- P501E Telephone # 1 - Value = 1-16 digits
- P502E Telephone # 2 - Value = 1-16 digits
- P503E Telephone # 3 - Value = 1-16 digits
- P504E Telephone # 4 - Value = 1-16 digits

Telephone No 3

MAXIMUM RE-TRIES PER TELEPHONE NUMBER

The addresses (P245E-P248E) are used to select the maximum number of dial attempts the panel will make for each telephone number

- P245E Maximum Dial Attempts for Ph # 1 - Value 0-99 (Default = 3)
- P246E Maximum Dial Attempts for Ph # 2 - Value 0-99 (Default = 3)
- P247E Maximum Dial Attempts for Ph # 3 - Value 0-99 (Default = 3)
- P248E Maximum Dial Attempts for Ph # 4 - Value 0-99 (Default = 3)

Retries Phone 3
3

PROGRAMMING TELEPHONE NUMBER REPORT FORMAT

This block of addresses (P241E - P244E) are used to set the reporting format which will be sent when an alarm occurs for each of the telephone numbers.

P241E-Telephone #1 Options	1E	Contact ID
(Default = 2)	2E	Domestic Dial
	3E	Pager
	4E	Voice Dialer
	5E	4 + 2 (Pulsed) 10 pps (1400 hz Handshake, 1800 hz transmit Tone)
	6E	4 + 2 (Pulsed) 10 pps (1400 hz Handshake, 1900 hz transmit Tone)
	7E	4 + 2 (Pulsed) 10 pps (2300 hz Handshake, 1800 hz transmit Tone)
	8E	4 + 2 (Pulsed) 10 pps (2300 hz Handshake, 1900 hz transmit Tone)
	9E	4 + 2 (Pulsed) 20 pps (1400 hz Handshake, 1800 hz transmit Tone)
	10E	4 + 2 (Pulsed) 20 pps (1400 hz Handshake, 1900 hz transmit Tone)
	11E	4 + 2 (Pulsed) 20 pps (2300 hz Handshake, 1800 hz transmit Tone)
	12E	4 + 2 (Pulsed) 20 pps (2300 hz Handshake, 1900 hz transmit Tone)
	13E	4 + 2 DTMF

Phone 1 Format
2

- Option 1 **Contact ID** - If this option is set for the telephone number, the panel will send a Contact ID message to a Monitoring Station.
- Option 2 **Domestic Dial** - If this option is set for the telephone number, the panel is expecting to dial a residential telephone number when an alarm occurs. The message sent consists of a siren tone over the phone to PW-8 the person called that an alarm is in progress. The alarm can be cancelled by the person called by pressing any button on a touch tone phone during the quiet period. If the alarm is cancelled by a valid user code the dialer will stop any further calls. **If the alarm is not reset or kissed off, the dialer will attempt to report the alarm/s again when the test time comes around. If you don't wish this to happen turn off all of the test days at P404E.**
- Option 3 **Pager** - Report alarm events using CROW "Pager" format. This format utilizes Telecoms' 026 pager network or other public subscriber networks, etc, to send numeric messages to a compatible pager. (NOTE :The client account number should not start with a "0")
- Option 4 **Voice Dialer** - If the optional voice board is fitted to the panel then selecting this option for the telephone number will allow preset voice messages to be sent via the telephone following an alarm. **If the alarm is not reset or kissed off, the dialer will attempt to report the alarm/s again when the test time comes around. If you don't wish this to happen turn off all of the test days at P404E.**
- Option 5 **4 + 2 (10 pps)** - This option transmits a 4 digit account code followed by a 2 digit event code to a central monitoring station. The handshake tone from the monitoring station must be 1400 hz and the transmit tone from the panel will be at 1800hz at 10 pulses per second.
- Option 6 **4 + 2 (10 pps)** - This option transmits a 4 digit account code followed by a 2 digit event code to a central monitoring station. The handshake tone from the monitoring station must be 1400 hz and the transmit tone from the panel will be at 1900hz at 10 pulses per second.
- Option 7 **4 + 2 (10 pps)** - This option transmits a 4 digit account code followed by a 2 digit event code to a central monitoring station. The handshake tone from the monitoring station must be 2300 hz and the transmit tone from the panel will be at 1800hz at 10 pulses per second.
- Option 8 **4 + 2 (10 pps)** - This option transmits a 4 digit account code followed by a 2 digit event code to a central monitoring station. The handshake tone from the monitoring station must be 2300 hz and the transmit tone from the panel will be at 1900hz at 10 pulses per second.
- Option 9 **4 + 2 (20 pps)** - This option transmits a 4 digit account code followed by a 2 digit event code to a central monitoring station. The handshake tone from the monitoring station must be 1400 hz and the transmit tone from the panel will be at 1800hz at 20 pulses per second.

- Option 10 **4 + 2 (20 pps)** - This option transmits a 4 digit account code followed by a 2 digit event code to a central monitoring station. The handshake tone from the monitoring station must be 1400 hz and the transmit tone from the panel will be at 1900hz at 20 pulses per second.
- Option 11 **4 + 2 (20 pps)** - This option transmits a 4 digit account code followed by a 2 digit event code to a central monitoring station. The handshake tone from the monitoring station must be 2300 hz and the transmit tone from the panel will be at 1800hz at 20 pulses per second
- Option 12 **4 + 2 (20 pps)** - This option transmits a 4 digit account code followed by a 2 digit event code to a central monitoring station. The handshake tone from the monitoring station must be 2300 hz and the transmit tone from the panel will be at 1900hz at 20 pulses per second.
- Option 13 **4 + 2 (DTMF)** - This option transmits a 4digit account code followed by a 2 digit event code plus a checksum using DTMF signals to a central monitoring station. The handshake tone from the monitoring station must be 1400 hz /2300 hz .

Note: P242E through P244E are as above but apply to Telephone # 2-4

PROGRAMMING TELEPHONE NUMBER REPORT OPTIONS

This block of addresses (P181E - P184E) are used to set the reporting options for each telephone number

- P181E-Telephone #1 Options**
- 1E** Stop if Kissed Off - Default **on**
 - 2E** Stay Call Progress - Default **on**
 - 3E** Blind Dial - Default off
 - 4E** Use Group Codes or Multiple Accounts - Default off
 - 5E** Send Restores - Default **on**
 - 6E** Send test Call to Monitoring Station - Default off
 - 7E** Spare - Default off
 - 8E** Spare - Default off

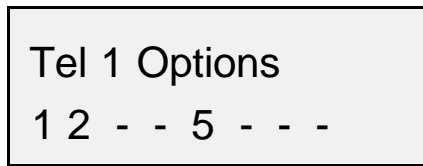

- Option 1 **Stop if Kissed Off**– If this option is turned on for the telephone number, the dialer will stop sending the alarm if the signal is kissed off and will not proceed with any other telephone numbers for that event. If not kissed off the dialer will continue for the maximum dial re-tries then cease reporting the alarm. If the event is not kissed off and the maximum re-tries limit is reached then the event is marked as unsent and will be added to the next event that causes the dialer to report. If this option is not turned on, the dialer will send the event for the maximum re-tries count or until kissed off but it will then proceed with any other telephone numbers also programmed.
- Option 2 **Stay Call Progress** - Stay call progress means that the dialer monitors the status of the dialing tone to determine whether the call is valid or not. If the call is not valid, i.e. Engaged, the panel will know and hang up the call and try again.
- Option 3 **Blind Dial** - When the dialer makes a call it looks for dial tone before making the call. If no dial tone is detected the panel hangs up and attempts another call. The panel will do this 3 times and if dal tone is still not detected it will make the call anyway. If blind dial is on, the panel skips the dial tone detection and dials 2 seconds after looping the line. (used where non standard or low level dial tone exists)
- Option 4 **Use Separate Accounts or Group Number** - When sending an alarm using Contact ID, the panel can either send separate account codes to report the two partitions (the default setting LED 4 Off) or, use one account code (Partition A) and use the group number to identify the two partitions.
- Option 5 **Send Restores** - When an alarm is generated the panel automatically sends a restore when the alarm is reset. If the monitoring company does not want restores they may be turned off with this option.
- Option 6 **Send Test call to Monitoring Station** - The automatic daily test call to a monitoring station can be disabled if not required by turning off this option.

Note: P182E through P184E are as above but applied to telephone numbers 2-4

CONTACT ID or 4+2 ACCOUNT CODES

The account code is the 4 digit number that identifies the panel to the Monitoring Station. If send Group numbers is set for Contact ID then the account number used is Partition "A". The special characters B,C,D,E & F can be entered at these addresses if required (see the table on page 35 for instructions).

- P506E Account Code For Partition "A"** - Value = 4 character code (Default = 0000)
- P507E Account Code For Partition "B"** - Value = 4 character code (Default = 0000)

Account No B

ZONE CONTACT ID CODE

This block of addresses (P321E - P328E) are used to set the Contact ID code that a Zone will transmit in an alarm. If a value of "0" or the "Bypass" button is entered at any of these addresses then the zone will not report via the Dialer.

- P321E Zone # 1 Contact ID Code** - 3 Digit Number (Default = 130)
- P322E Zone # 2 Contact ID Code** - 3 Digit Number (Default = 130)
- P323E Zone # 3 Contact ID Code** - 3 Digit Number (Default = 130)
- P324E Zone # 4 Contact ID Code** - 3 Digit Number (Default = 130)
- P325E Zone # 5 Contact ID Code** - 3 Digit Number (Default = 130)
- P326E Zone # 6 Contact ID Code** - 3 Digit Number (Default = 130)
- P327E Zone # 7 Contact ID Code** - 3 Digit Number (Default = 130)
- P328E Zone # 8 Contact ID Code** - 3 Digit Number (Default = 130)

CID for Zone1
130

PANIC ALARM CONTACT ID CODE

This address (P329E) is used to set the Contact ID code that a Keypad "Panic" or "1&3" alarm will transmit.

- P329E Keypad Panic Alarm Contact ID Code** - 3 Digit Number (Default = 120)

CID for Panic
120

FIRE ALARM CONTACT ID CODE

This address (P330E) is used to set the Contact ID code that a Keypad Fire "4&6" alarm will transmit.

- P330E Keypad Fire Alarm Contact ID Code** - 3 Digit Number (Default = 110)

CID for Fire
110

MEDICAL ALARM CONTACT ID CODE

This address (P331E) is used to set the Contact ID code that a Keypad Medical "7&9" alarm will transmit.

CID for Medic
100

PROGRAMMING DIALER 4 + 2 REPORTING CODES

The dialer is capable of reporting most events in 4+2 format to a monitoring station. There are various 4+2 formats (see telephone mode options on page 39). The 4+2 format consists of a 4 character account code, plus a 2 character event code. The account & event codes can be any combination of the values 1234567890BCDEF (see programming chart on page 35). If a value of "00" is programmed into any 4+2 address (or the "Bypass" key is entered at a selected 4+2 address) then no report will be generated for that event.

ZONE ALARM 4 + 2 REPORTING CODE

This block of addresses (P511E - P518E) are used to set the 4 + 2 code that a Zone will transmit in an alarm.

- P511E Zone # 1 4 + 2 Code - 2 Digit Number (Default = 01)
- P512E Zone # 2 4 + 2 Code - 2 Digit Number (Default = 02)
- P513E Zone # 3 4 + 2 Code - 2 Digit Number (Default = 03)
- P514E Zone # 4 4 + 2 Code - 2 Digit Number (Default = 04)
- P515E Zone # 5 4 + 2 Code - 2 Digit Number (Default = 05)
- P516E Zone # 6 4 + 2 Code - 2 Digit Number (Default = 06)
- P517E Zone # 7 4 + 2 Code - 2 Digit Number (Default = 07)
- P518E Zone # 8 4 + 2 Code - 2 Digit Number (Default = 08)

4+2 Alarm Zone 1
A1

ZONE ALARM 4 + 2 RESTORE CODE

This block of addresses (P521E - P528E) are used to set the 4 + 2 code that a Zone will transmit when it is restored following an alarm.

- P521E Zone # 1 4 + 2 Code - 2 Digit Number (Default = 11)
- P522E Zone # 2 4 + 2 Code - 2 Digit Number (Default = 12)
- P523E Zone # 3 4 + 2 Code - 2 Digit Number (Default = 13)
- P524E Zone # 4 4 + 2 Code - 2 Digit Number (Default = 14)
- P525E Zone # 5 4 + 2 Code - 2 Digit Number (Default = 15)
- P526E Zone # 6 4 + 2 Code - 2 Digit Number (Default = 16)
- P527E Zone # 7 4 + 2 Code - 2 Digit Number (Default = 17)
- P528E Zone # 8 4 + 2 Code - 2 Digit Number (Default = 18)

4+2 Restr Zone 1
11

ZONE BYPASSED 4 + 2 CODE

This block of addresses (P581E - P588E) are used to set the 4 + 2 code that a Zone will transmit if it is manually or automatically excluded at the time of Arming.

- P581E Zone # 1 Bypassed 4 + 2 Code - 2 Digit Number (Default = 21)
- P582E Zone # 2 Bypassed 4 + 2 Code - 2 Digit Number (Default = 22)
- P583E Zone # 3 Bypassed 4 + 2 Code - 2 Digit Number (Default = 23)
- P584E Zone # 4 Bypassed 4 + 2 Code - 2 Digit Number (Default = 24)
- P585E Zone # 5 Bypassed 4 + 2 Code - 2 Digit Number (Default = 25)
- P586E Zone # 6 Bypassed 4 + 2 Code - 2 Digit Number (Default = 26)
- P587E Zone # 7 Bypassed 4 + 2 Code - 2 Digit Number (Default = 27)
- P588E Zone # 8 Bypassed 4 + 2 Code - 2 Digit Number (Default = 28)

4+2 Byp Zone 1
21

ZONE BYPASSE RESTORE 4 + 2 CODE

This block of addresses (P591E - P598E) are used to set the 4 + 2 code that a Zone will transmit if a manual or automatic exclusion has been restored.

- P591E Zone # 1 Bypass Restore 4 + 2 Code - 2 Digit Number (Default = 31)

- P592E Zone # 2 Bypass Restore 4 + 2 Code - 2 Digit Number (Default = 32)
- P593E Zone # 3 Bypass Restore 4 + 2 Code - 2 Digit Number (Default = 33)
- P594E Zone # 4 Bypass Restore 4 + 2 Code - 2 Digit Number (Default = 34)
- P595E Zone # 5 Bypass Restore 4 + 2 Code - 2 Digit Number (Default = 35)
- P596E Zone # 6 Bypass Restore 4 + 2 Code - 2 Digit Number (Default = 36)
- P597E Zone # 7 Bypass Restore 4 + 2 Code - 2 Digit Number (Default = 37)
- P598E Zone # 8 Bypass Restore 4 + 2 Code - 2 Digit Number (Default = 38)

4+2BypRestZone1
31

MISCELLANEOUS 4 + 2 REPORTING CODES

This block of addresses are used to set the 4 + 2 code for Miscellaneous reporting functions

- P519E System Tamper 4 + 2 Code - 2 Digit Number (Default = 86)
- P531E Panic Alarm 4 + 2 Code - 2 Digit Number (Default = 88)
- P532E Fire Alarm 4 + 2 Code - 2 Digit Number (Default = 89)
- P533E Medical Alarm 4 + 2 Code - 2 Digit Number (Default = 90)
- P537E Low Battery 4 + 2 Code - 2 Digit Number (Default = 94)
- P538E Mains Failure 4 + 2 Code - 2 Digit Number (Default = 95)
- P590E Automatic Test 4 + 2 Code - 2 Digit Number (Default = 85)

4+2 Low Battery
94

MISCELLANEOUS 4 + 2 RESTORE CODES

This block of addresses are used to set the 4 + 2 code for Miscellaneous restore reporting functions

- P529E System Tamper Restore 4 + 2 Code - 2 Digit Number (Default = 87)
- P534E Panic Alarm Restore 4 + 2 Code - 2 Digit Number (Default = 91)
- P535E Fire Alarm Restore 4 + 2 Code - 2 Digit Number (Default = 92)
- P536E Medical Alarm Restore 4 + 2 Code - 2 Digit Number (Default = 93)
- P539E Low Battery Restore 4 + 2 Code - 2 Digit Number (Default = 96)
- P540E Mains Failure Restore 4 + 2 Code - 2 Digit Number (Default = 97)

4+2 Fire Restr
92

ARMED BY USER 4 + 2 CODE

This block of addresses are used to set the 4 + 2 code that will transmitted each time an individual User Arms the alarm system.

- P541E Armed by User # 1 4 + 2 Code - 2 Digit Number (Default = 41)
- P542E Armed by User # 2 4 + 2 Code - 2 Digit Number (Default = 42)
- P543E Armed by User # 3 4 + 2 Code - 2 Digit Number (Default = 43)
- P544E Armed by User # 4 4 + 2 Code - 2 Digit Number (Default = 44)
- P545E Armed by User # 5 4 + 2 Code - 2 Digit Number (Default = 45)
- P546E Armed by User # 6 4 + 2 Code - 2 Digit Number (Default = 46)
- P547E Armed by User # 7 4 + 2 Code - 2 Digit Number (Default = 47)
- P548E Armed by User # 8 4 + 2 Code - 2 Digit Number (Default = 48)
- P548E Armed by User # 9 4 + 2 Code - 2 Digit Number (Default = 49)
- P550E Armed by User #10 4 + 2 Code - 2 Digit Number (Default = 50)

4+2 Arm User 1
41

P569E Armed by "ARM" Button or Key-switch 4 + 2 Code - 2 Digit Number (Default = 81)
P570E Stay Mode Arming 4 + 2 Code - 2 Digit Number (Default = 82)

DISARMED BY USER 4 + 2 CODE

This block of addresses are used to set the 4 + 2 code that will transmitted each time an individual User Disarms the alarm system.

P551E Disarmed by User # 1 4 + 2 Code - 2 Digit Number (Default = 51)
P552E Disarmed by User # 2 4 + 2 Code - 2 Digit Number (Default = 52)
P553E Disarmed by User # 3 4 + 2 Code - 2 Digit Number (Default = 53)
P554E Disarmed by User # 4 4 + 2 Code - 2 Digit Number (Default = 54)
P555E Disarmed by User # 5 4 + 2 Code - 2 Digit Number (Default = 55)
P556E Disarmed by User # 6 4 + 2 Code - 2 Digit Number (Default = 56)
P557E Disarmed by User # 7 4 + 2 Code - 2 Digit Number (Default = 57)
P558E Disarmed by User # 8 4 + 2 Code - 2 Digit Number (Default = 58)
P559E Disarmed by User # 9 4 + 2 Code - 2 Digit Number (Default = 59)
P560E Disarmed by User #10 4 + 2 Code - 2 Digit Number (Default = 60)
P579E Disarmed by "Arm" Button or Key-switch 4 + 2 Code - 2 Digit Number (Default = 83)

4+2 DisArm User1
51

ARMED BY RADIO USER 4 + 2 CODE

This block of addresses are used to set the 4 + 2 code that will transmitted each time an individual User Arms the alarm system via there Radio Key.

P561E Armed by Radio User # 1 4 + 2 Code - 2 Digit Number (Default = 61)
P562E Armed by Radio User # 2 4 + 2 Code - 2 Digit Number (Default = 62)
P563E Armed by Radio User # 3 4 + 2 Code - 2 Digit Number (Default = 63)
P564E Armed by Radio User # 4 4 + 2 Code - 2 Digit Number (Default = 64)
P565E Armed by Radio User # 5 4 + 2 Code - 2 Digit Number (Default = 65)
P566E Armed by Radio User # 6 4 + 2 Code - 2 Digit Number (Default = 66)
P567E Armed by Radio User # 7 4 + 2 Code - 2 Digit Number (Default = 67)
P568E Armed by Radio User # 8 4 + 2 Code - 2 Digit Number (Default = 68)

4+2RadioArmUser
61

DISARMED BY RADIO USER 4 + 2 CODE

This block of addresses are used to set the 4 + 2 code that will transmitted each time an individual User Disarms the alarm system via there Radio Key.

P571E Disarmed by Radio User # 1 4 + 2 Code - 2 Digit Number (Default = 71)
P572E Disarmed by Radio User # 2 4 + 2 Code - 2 Digit Number (Default = 72)
P573E Disarmed by Radio User # 3 4 + 2 Code - 2 Digit Number (Default = 73)
P574E Disarmed by Radio User # 4 4 + 2 Code - 2 Digit Number (Default = 74)
P575E Disarmed by Radio User # 5 4 + 2 Code - 2 Digit Number (Default = 75)
P576E Disarmed by Radio User # 6 4 + 2 Code - 2 Digit Number (Default = 76)
P577E Disarmed by Radio User # 7 4 + 2 Code - 2 Digit Number (Default = 77)
P578E Disarmed by Radio User # 8 4 + 2 Code - 2 Digit Number (Default = 78)

4+2RadioArmUser
71

DISARMED UNDER DURESS 4 + 2 CODE

This address is used to set the 4 + 2 code that will be transmitted if the alarm system is disarmed under duress.

P580E Duress Alarm 4 + 2 Code - 2 Digit Number (Default = 84)

PROGRAMMING VOICE BOARD MESSAGES

This block of addresses (P251E - P258E) are used to select a voice message that a Zone will transmit in an alarm. For this option to work the optional Voice Board must be fitted. If a value of "0" or the "Bypass" button is entered at any of these addresses then the zone will not report via the Dialer in either **Voice or Domestic** modes.

P251E Zone 1 Voice Message Number - (Default = 1) Value= 0-99

P252E Zone 2 Voice Message Number - (Default = 1)

P253E Zone 3 Voice Message Number - (Default = 1)

P254E Zone 4 Voice Message Number - (Default = 1)

P255E Zone 5 Voice Message Number - (Default = 1)

P256E Zone 6 Voice Message Number - (Default = 1)

P257E Zone 7 Voice Message Number - (Default = 1)

P258E Zone 8 Voice Message Number - (Default = 1)

Zone 4 Msg No

1

MISCELLANEOUS VOICE BOARD MESSAGES

This block of addresses (P259E - P262E) are used to select a voice message that various Alarms will transmit via the dialer. For this option to work the optional Voice Board must be fitted. If a value of "0" or the "Bypass" button is entered at any of these addresses then the alarm will not report via the Dialer in either **Voice or Domestic** modes.

P259E Panic Alarm Voice Message Number - (Default = 1) Value= 0-99

P260E Fire Alarm Voice Message Number - (Default = 1)

P261E Medical Alarm Voice Message Number - (Default = 1)

P262E Battery Low Voice Message Number - (Default = 1)

Medic Msg No

1

START MESSAGE NUMBER FOR DTMF CONTROL

This address (P250E) sets the start message for the DTMF remote control messages. The remote control messages are set in a fixed sequence (refer to the addendum sheet supplied with the 90 second voice board for this list). If the voice board is being used to indicate alarms using voice messages and DTMF remote control is also being used, the alarm messages must be recorded first. When all alarm messages have been recorded you can then record the remote control messages eg if you have 9 alarm messages recorded before the remote control messages, the value entered at this address must be 10. A value other than "0" must be entered at this address for the function to work.

P250E Start of DTMF Remote Control Messages - (Default = 0) Value= 0-99

Start of Msgs

0

DTMF REMOTE CONTROL CODES

This block of addresses (P334E - P337E) are used to program the 4 digit DTMF Remote Control Codes. These codes allow a valid user to set or unset the alarm, turn outputs On or Off or enable the microphone input from a remote telephone. Please refer to the User Operating guide or the addendum sheet supplied with the voice board for the full operational sequence.

P334E Remote Control Code for Area "A" - (Default = 0)

P335E Remote Control Code for Area "B" - (Default = 0)

P336E Remote Control Code for Output Control - (Default = 0)

P337E Remote Control Code to Enable the Microphone Input -

(Default = 0)

DTMF control A

0

AUTO-ANSWER RING COUNT

The auto-answer ring count is the number of rings the panel must count before answering an in-coming call. For Fax defeat to work the auto-answer ring count must be set to a number other than "0". (typically 25 rings)

P249E Auto-answer Ring Count - Value 0-99 (0= Auto-answer disabled) - Default = 8

MAINS FAIL REPORTING DELAY

This address (P319E) is used to set a timer that delays the reporting of Mains Failure to a Monitoring Station. If the mains voltage returns before the timer expires then no report is sent.

P319E Mains Failure Report Delay - Value 0-9999 Seconds (Default = 600)

Mains Fail Report 600

SETTING DIALER TEST REPORT PARAMETERS

This option sets the days of the week and the time when an automatic test report is sent to a central monitoring station. PLEASE NOTE: If daylight saving adjustments are set (P408-P413) do not set the value at P402 to be a value between 1-3 am otherwise unwanted results will occur at the start & finish of daylight saving. **Also, if a Domestic or Voice mode alarm is initiated but not reset or kissed off, when the test time comes around the dialer will attempt to report the event/s again. To prevent this from happening, turn off ALL days at P404E.**

P402E Automatic Test Report Hour/Minute - Value 0-2359

P404E Automatic Test Report Day/s of Week - Value 1-7 (where 1 = Sunday, 2 = Monday, 3 = Tuesday, etc)

UPLOAD/DOWNLOAD SITE CODE NUMBER

The upload/download site code number must be entered if the panel is set for auto-answer as this provides a security access level to the panel. The number can be up to 8 characters in length. Valid characters for this number are 0-9, B-F (refer to the chart on page 35).

P505E Site Code Number - 8 characters

Up/Dn Security C

PW-8 PROGRAM SUMMARY GUIDE

The following program summary is an abbreviated version of all the PW-8 program addresses. This is intended as a quick guide to finding a program address. The program addresses are in numerical order with page references beside them so you can get more detailed information if required. **Because this section is in numerical order, any addresses relating to the Dialer are not necessarily grouped together. To identify Dialer options each heading relating to the Dialer are highlighted by an “***” either side of the heading.**

Programming User Codes

P1E	User Code # 1 - Default = 123 (If erased by mistake the code will default to 987654)	Page 13
P2E	User Code # 2	Page 13
P3E	User Code # 3	Page 13
P4E	User Code # 4	Page 13
P5E	User Code # 5	Page 13
P6E	User Code # 6	Page 13
P7E	User Code # 7	Page 13
P8E	User Code # 8	Page 13
P9E	User Code # 9	Page 13
P10E	User Code # 10	Page 13
P11E	User Code # 11 - Installer Code (Default = 000000)	Page 13

User Code Options

P21E	User Options Code # 1 (Default 1-8)	P21E-P30E Options	Page 14
P22E	User Options Code # 2 (Default 1-6)	1 = Assigned to Area “A”	Page 14
P23E	User Options Code # 3 (Default 1-6)	2 = Assigned to Area “B”	Page 14
P24E	User Options Code # 4 (Default 1-6)	3 = Code can Arm Area	Page 14
P25E	User Options Code # 5 (Default 1-6)	4 = Code can Disarm Area	Page 14
P26E	User Options Code # 6 (Default 1-6)	5 = Code can arm Stay Mode	Page 14
P27E	User Options Code # 7 (Default 1-6)	6 = Code can disarm Stay Mode	Page 14
P28E	User Options Code # 8 (Default 1-6)	7 = User can Change their Code	Page 14
P29E	User Options Code # 9 (Default 1-6)	8 = User can Change Codes 1-10	Page 14
P30E	User Options Code # 10 (Default 1-6)		Page 14

Programming Output Options “A”

P31E	Options for Output # 1 (Default None)	P31E-P34E Options	Page 14
P32E	Options for Output # 2 (Default None)	1 = Invert Output	
P33E	Options for Output # 3 (Default None)	2 = Flash Output	
P34E	Options for Output # 4 (Default 1)	3 = Single Pulse to Output	
P35E	Options for Output # 5 (Default None)	4 = Lockout Output	
P36E	Options for Output # 6 (Default None)	5 = Siren Driver to output	
P37E	Options for Output # 7 (Default None)	6 = “Control” button & DTMF Remote Control can operate O/P	
P38E	Options for Output # 8 (Default None)	7 = Output Flashes on 24 Hour Alarm	
		8 = Day zones linked to Pulse Timer (Chime)	

Programming Output Options “B”

P41E	Options for Output # 1 (Default 1,2,5)	P41E-P48E Options	Page 15
P42E	Options for Output # 2 (Default 1,2,5)	1 = Pendant Panic to Output	
P43E	Options for Output # 3 (Default None)	2 = Keypad Panic to Output	
P44E	Options for Output # 4 (Default None)	3 = Keypad Fire to Output	
P45E	Options for Output # 5 (Default None)	4 = Keypad Medical to output	
P46E	Options for Output # 6 (Default None)	5 = System Tamper to Output	

- P47E Options for Output # 7 (Default None) 6 = Duress Alarm to Output
- P48E Options for Output # 8 (Default None) 7 = Mains Fail to Output
- 8 = Battery Low to output

Mapping Zone Alarms To Outputs

- P51E Normal Zone Alarms 1-8 to Output # 1 (Default= All Zones) Page 16
- P52E Normal Zone Alarms 1-8 to Output # 2 (Default= All Zones) Page 16
- P53E Normal Zone Alarms 1-8 to Output # 3 (Default= None) Page 16
- P54E Normal Zone Alarms 1-8 to Output # 4 (Default= None) Page 16
- P55E Normal Zone Alarms 1-8 to Output # 5 (Default= None) Page 16
- P56E Normal Zone Alarms 1-8 to Output # 6 (Default= None) Page 16
- P57E Normal Zone Alarms 1-8 to Output # 7 (Default= None) Page 16
- P58E Normal Zone Alarms 1-8 to Output # 8 (Default= None) Page 16

Mapping Stay Zone Alarms To Outputs

- P61E Stay Mode Zone Alarms 1-8 to Output # 1 (Default= All Zones) Page 16
- P62E Stay Mode Zone Alarms 1-8 to Output # 2 (Default= All Zones) Page 16
- P63E Stay Mode Zone Alarms 1-8 to Output # 3 (Default= None) Page 16
- P64E Stay Mode Zone Alarms 1-8 to Output # 4 (Default= None) Page 16
- P65E Stay Mode Zone Alarms 1-8 to Output # 5 (Default= None) Page 16
- P66E Stay Mode Zone Alarms 1-8 to Output # 6 (Default= None) Page 16
- P67E Stay Mode Zone Alarms 1-8 to Output # 7 (Default= None) Page 16
- P68E Stay Mode Zone Alarms 1-8 to Output # 8 (Default= None) Page 16

Mapping 24 Hour Zone Alarms To Outputs

- P71E 24 Hour Zone Alarms 1-8 to Output # 1 (Default= All Zones) Page 16
- P72E 24 Hour Zone Alarms 1-8 to Output # 2 (Default= All Zones) Page 16
- P73E 24 Hour Zone Alarms 1-8 to Output # 3 (Default= None) Page 16
- P74E 24 Hour Zone Alarms 1-8 to Output # 4 (Default= None) Page 16
- P75E 24 Hour Zone Alarms 1-8 to Output # 5 (Default= None) Page 16
- P76E 24 Hour Zone Alarms 1-8 to Output # 6 (Default= None) Page 16
- P77E 24 Hour Zone Alarms 1-8 to Output # 7 (Default= None) Page 17
- P78E 24 Hour Zone Alarms 1-8 to Output # 8 (Default= None) Page 17

Mapping Day Zones (CHIME) To Outputs

- P81E Day Zones 1-8 to Output # 1 (Default= None) Page 17
- P82E Day Zones 1-8 to Output # 2 (Default= None) Page 17
- P83E Day Zones 1-8 to Output # 3 (Default= None) Page 17
- P84E Day Zones 1-8 to Output # 4 (Default= None) Page 17
- P85E Day Zones 1-8 to Output # 5 (Default= None) Page 17
- P86E Day Zones 1-8 to Output # 6 (Default= None) Page 17
- P87E Day Zones 1-8 to Output # 7 (Default= None) Page 17
- P88E Day Zones 1-8 to Output # 8 (Default= None) Page 17

Mapping Zone Tamper To Outputs

- P91E Zone Tamper 1-8 to Output # 1 (Default= 1-8) Page 17
- P92E Zone Tamper 1-8 to Output # 2 (Default= 1-8) Page 17
- P93E Zone Tamper 1-8 to Output # 3 (Default= None) Page 17

P94E	Zone Tamper 1-8 to Output # 4 (Default= None)	Page 17
P95E	Zone Tamper 1-8 to Output # 5 (Default= None)	Page 17
P96E	Zone Tamper 1-8 to Output # 6 (Default= None)	Page 17
P97E	Zone Tamper 1-8 to Output # 7 (Default= None)	Page 17
P98E	Zone Tamper 1-8 to Output # 8 (Default= None)	Page 17

Mapping Radio Keys To Outputs

P101E	Radio Key 1-8 to Output # 1 (Default= None)	Page 17
P102E	Radio Key 1-8 to Output # 2 (Default= None)	Page 17
P103E	Radio Key 1-8 to Output # 3 (Default= None)	Page 17
P104E	Radio Key 1-8 to Output # 4 (Default= None)	Page 17
P105E	Radio Key 1-8 to Output # 5 (Default= None)	Page 17
P106E	Radio Key 1-8 to Output # 6 (Default= None)	Page 17
P107E	Radio Key 1-8 to Output # 7 (Default= None)	Page 17
P108E	Radio Key 1-8 to Output # 8 (Default= None)	Page 17

Temporary Output Disable

P109E	Temporary Output Disable - Output 1-8	Page 18
-------	---------------------------------------	---------

Partition "A" Options

P110E	Partition "A" Options (Default= 4 & 5)	P110E Options	Page 18
		1 = Arm Button Required Before Code to Set	
		2 = Stay Button Required Before Code to Set Stay Mode	
		3 = Code required to Set	
		4 = Arm Button can disarm during Exit Delay	
		5 = Stay Button can disarm Stay Mode at any time	
		6 = No Exit beeps to Keypads in Stay Mode	
		7 = Enable Key-switch	
		8 = Key-switch Mode	

Partition "A" Output Options

P111E	Area "A" Opt. O/P # 1 (Default= None)	P111E-P118E Options	Page 19
P112E	Area "A" Opt. O/P # 2 (Default= None)	1 = Arm Status to Output	
P113E	Area "A" Opt. O/P # 3 (Default= 1&2)	2 = Stay Arm Status to Output	
P114E	Area "A" Opt. O/P # 4 (Default= 7)	3 = Disarm Status to Output	
P115E	Area "A" Opt. O/P # 5 (Default= None)	4 = Pendant Chirps on Arm	
P116E	Area "A" Opt. O/P # 6 (Default= None)	5 = Pendant Chirps on Stay Mode Arm	
P117E	Area "A" Opt. O/P # 7 (Default= None)	6 = Pendant Chirps on Disarming	
P118E	Area "A" Opt. O/P # 8 (Default= None)	7 = Pulse on Arming to Output	
		8 = Pulse on Disarming to Output	

Partition "B" Options

P120E	Partition "B" Options (Default= 4 & 5)	P120E Options	Page 20
		1 = Arm Button Required Before Code to Set	
		2 = Stay Button Required Before Code to Set Stay Mode	
		3 = Code required to Set	
		4 = Arm Button can disarm during Exit Delay	
		5 = Stay Button can disarm Stay Mode at any time	
		6 = No Exit beeps to Keypads in Stay Mode	
		7 = Enable Key-switch	
		8 = Key-switch Mode	

Partition "B" Output Options

P121E	Area "B" Opt. O/P # 1 (Default= None)	P121E-P128E Options	Page 20
P122E	Area "B" Opt. O/P # 2 (Default= None)	1 = Arm Status to Output	
P123E	Area "B" Opt. O/P # 3 (Default= None)	2 = Stay Arm Status to Output	
P124E	Area "B" Opt. O/P # 4 (Default= 7)	3 = Disarm Status to Output	
P125E	Area "B" Opt. O/P # 5 (Default= None)	4 = Pendant Chirps on Arm	
P126E	Area "B" Opt. O/P # 6 (Default= None)	5 = Pendant Chirps on Stay Mode Arm	
P127E	Area "B" Opt. O/P # 7 (Default= None)	6 = Pendant Chirps on Disarming	
P128E	Area "B" Opt. O/P # 8 (Default= None)	7 = Pulse on Arming to Output	
		8 = Pulse on Disarming to Output	

Programming Zone EOL Options

P130E	Zone EOL Options - Value 1-8 (Default = OFF)	Page 21
-------	--	---------

Programming Zone Options

P129E	24 Hour Fire Zone	Zones 1-8 (Default = No zones)	Page 23
P131E	Partition "A" Zones	Zones 1-8 (Default = All zones)	Page 22
P132E	Partition "B" Zones	Zones 1-8 (Default = No zones)	Page 22
P133E	Zone is NC or NO	Zones 1-8 (Default = All zones are NC)	Page 22
P134E	Radio Zone Input	Zones 1-8 (Default = No zones)	Page 22
P135E	Manually Bypass Zone	Zones 1-8 (Default = All zones)	Page 22
P136E	Auto-Bypass Zone	Zones 1-8 (Default = No zones)	Page 22
P137E	Handover Zone	Zones 1-8 (Default = Zone 2)	Page 22
P138E	Two Trigger Zone	Zones 1-8 (Default = No zones)	Page 22
P139E	Stay Mode Zone	Zones 1-8 (Default = Zone 1)	Page 22
P140E	24 Hour Zone	Zones 1-8 (Default = No zones)	Page 23
P141E	Non-Latching 24 Hour Zone	Zones 1-8 (Default = No zones)	Page 23
P142E	Lockout Zone	Zones 1-8 (Default = No zones)	Page 23
P143E	Day Zone (CHIME)	Zones 1-8 (Default = No zones)	Page 23
P144E	Permanent Day Zone (CHIME)	Zones 1-8 (Default = No zones)	Page 23
P145E	Can Arm if not Sealed	Zones 1-8 (Default = No zones)	Page 23
P146E	Report excludes to Dialer	Zones 1-8 (Default = All zones)	Page 23
P147E	Multiple Alarms to Dialer	Zones 1-8 (Default = All zones)	Page 23
P148E	Report Zone Tamper to Dialer	Zones 1-8 (Default = All zones)	Page 23
P149E	Zones Report to Area B Account	Zones 1-8 (Default = No zones)	Page 23
P150E	Zones with Inactivity Timer	Zones 1-8 (Default = No zones)	Page 23

Radio Pendant Options "A"

P151E	Radio Key # 1 Opt (Default= 1,3,4)	P151E-P158E Options	Page 28
P152E	Radio Key # 2 Opt (Default= 1,3,4)	1 = Assigned to Area "A"	Page 28
P153E	Radio Key # 3 Opt (Default= 1,3,4)	2 = Assigned to Area "B"	Page 28
P154E	Radio Key # 4 Opt (Default= 1,3,4)	3 = Can Arm Area	Page 28
P155E	Radio Key # 5 Opt (Default= 1,3,4)	4 = Can Disarm Area	Page 28
P156E	Radio Key # 6 Opt (Default= 1,3,4)	5 = Can arm Stay Mode	Page 28
P157E	Radio Key # 7 Opt (Default= 1,3,4)	6 = Can disarm Stay Mode	Page 28
P158E	Radio Key # 8 Opt (Default= 1,3,4)	7 = Spare	Page 28
		8 = Disabled if Panel is in Alarm	

**Radio Pendant Options "B" **

P161E	Radio Key # 1 Options (Default= None)	P161E-P168E Options	Page 28
P162E	Radio Key # 2 Options (Default= None)	1 = Pendant Can Turn Output On	Page 28
P163E	Radio Key # 3 Options (Default= None)	2 = Pendant Can Turn Output Off	Page 28
P164E	Radio Key # 4 Options (Default= None)	3 = Visonic Powercode Battery Low	Page 28

P165E	Radio Key # 5 Options (Default= None)	4 = Spare	Page 28
P166E	Radio Key # 6 Options (Default= None)	5 = Send Panic Alarm Through Dialer	Page 28
P167E	Radio Key # 7 Options (Default= None)	6 = Causes Immediate Panic	Page 28
P168E	Radio Key # 8 Options (Default= None)	7 = Causes Delayed Panic (1.5 Sec) 8 = Ness Battery Low	Page 28

Miscellaneous Panel Options # 1

P169E	Misc. Panel Options # 1 (Default= 3)	P169E Options 1 = Turn KP LED's when Armed 2 = Keypad "Panic" Button instant or delayed 3 = Direct access to program mode for the installer code.	Page 31
--------------	---	---	---------

Miscellaneous Panel Options # 2

P170E	Misc. Panel Options (Default= 4,7)	P170E Options 1 = Panel Tamper NC or EOL 2 = Installer Lockout 3 = Disable Mains Fail Test 4 = Arm only if sealed 5 = No audible keypad beep on supervised radio fault 6 = No audible keypad beep on Zone Inactivity Timeout 7 = "Control" Button Disables Day Zones 8 = Silent 24 Hour Zone (No Keypad Beep)	Page 32
--------------	---	--	---------

Keypad Partition Assignment

P171E	Keypads Assigned To Partition "A" - Value Keypad 1-8 (Default= All Keypads)	Page 29
P172E	Keypads Assigned To Partition "B" - Value Keypad 1-8 (Default= No Keypads)	Page 29

Keypads with Panic Button Enabled

P173E	Keypads with Panic Button Enabled - Value Keypad 1-8 (Default= All Keypads)	Page 29
--------------	--	---------

Keypads Panic (1&3) or (CHIME&CONTROL) Enabled

P174E	Keypads panic 1 & 3 or CHIME&CONTROL Enabled - Value Keypad 1-8 (Default= No Keypads)	Page 30
--------------	--	---------

Keypad and Radio Panic Beeps to Keypad Enabled

P175E	Keypad & Radio Panic Beeps to Keypad Enabled - Value Keypad 1-8 (Default= All Keypads)	Page 30
--------------	---	---------

Keypads Fire (4&6) or (CHIME&B) Enabled

P176E	Keypads FIRE 4 & 6 or CHIME&B Enabled - Value Keypad 1-8 (Default= No Keypads)	Page 30
--------------	---	---------

Fire Beep to Keypad Enabled

P177E	Fire Beep to Keypad Enabled - Value Keypad 1-8 (Default= No Keypads)	Page 30
--------------	---	---------

Keypads Medical (7&9) or (A&B) Enabled

P178E Keypads Medical 7 & 9 or A&B Function Enabled - Value Keypad 1-8 (Default= No Keypads) Page 31

Medical Beep to Keypad Enabled

P179E Medical Beep to Keypad Enabled - Value Keypad 1-8 (Default= No Keypads) Page 31

Stay Button can Disarm when in Stay Mode Enabled

P180E Stay Button can Disarm when in Stay Mode - Value Keypad 1-8 (Default 1 & 4) Page 31

Telephone Number Reporting Options

P181E Options for Telephone # 1	P181E-P184E Options (Default =1,2,5)	Page 40
P182E Options for Telephone # 2	1 = Stop Dialing if Kissed off	Page 40
P183E Options for Telephone # 3	2 = Stay Call Progress	Page 40
P184E Options for Telephone # 4	3 = Blind Dial	Page 40
	4 = Use Group Numbers for Contact ID	
	5 = Send Restores	
	6 = Send Test Calls	
	7 = Spare	
	8 = Spare	

Dialer Programming Options

P185E Dialer options	P185E Options (Default =1,2, 7)	Page 35
	1 = Dialer is Enabled	
	2 = Fax Defeat	
	3 = Disable Telephone Line Monitoring	
	4 = DTMF or Pulse Dial (For DTMF, 4&5 must both be OFF)	
	5 = DTMF or Reverse Pulse Dial (For DTMF, 4&5 must both be OFF)	
	6 = Spare	
	7 = Auto Detect Modem Mode	
	8 = Bell 103 or V21	

Dialer Reporting Options "A"*

P186E Dialer Options "A"	P186E Options (Default = 1,2,4,5,6,7,8)	Page 36
	1 = Report Duress Alarm	
	2 = Report Mains Fail	
	3 = Report Battery low	
	4 = Report Radio Battery Low	
	5 = Report system Tamper	
	6 = Report Line Fail	
	7 = Report Supervised Radio Alarm	
	8 = Report Zone Inactivity Alarm	

Dialer Reporting Options "B"*

P187E Dialer Options for "B"	P187E Options (Default = 1,2,3)	Page 36
	1 = Report Manual Panic Alarm	
	2 = Report Manual Fire Alarm	
	3 = Report Manual Medical Alarm	

****Dialer Reporting Options "C"****

P188E Dialer Options for "B"	P188E Options (Default = 1,2)	Page 37
	1 = Report Arm/Disarm	
	2 = Report Stay Mode Arm/Disarm	
	3 = Report Disarm only after an Activation	
	4 = Report Stay Mode Disarm only after an Activation	
	5 = Report 24 Hour Alarms when set to Domestic/Voice mode	
	6 = Send arm immediate or after exit delay	
	7 = Report Zone alarms in Stay Mode	
	8 = Spare	

****Keypad Listen-in Options****

P189E Keypad Listen-in Options	P189E Options (Default = 1-7)	Page 37
	1 = Enabled During Dialing in Disarm State only	
	2 = Enabled During Dialing in Armed State only	
	3 = Enabled During Dialing in Stay Mode State only	
	4 = Enabled Throughout the call in Disarm State only	
	5 = Enabled Throughout the call in Armed State only	
	6 = Enabled Throughout the call in Stay Mode State only	
	7 = Listen-in Enabled when the panel answers a call	
	8 = Enabled at All Times	

****Output # 1 Listen-in Options****

P190E Output # 1 Listen-in Options	P190E Options (Default = None)	Page 38
	1 = Enabled During Dialing in Disarm State only	
	2 = Enabled During Dialing in Armed State only	
	3 = Enabled During Dialing in Stay Mode State only	
	4 = Enabled Throughout the call in Disarm State only	
	5 = Enabled Throughout the call in Armed State only	
	6 = Enabled Throughout the call in Stay Mode State only	
	7 = Listen-in Enabled when the panel answers a call	
	8 = Enabled at All Times	

Output Delay ON time

P201E Output 1 Delay ON Time - Value 0-255 Seconds (Default = 0 Sec)	Page 25
P202E Output 2 Delay ON Time - Value 0-255 Seconds (Default = 0 Sec)	Page 25
P203E Output 3 Delay ON Time - Value 0-255 Seconds (Default = 0 Sec)	Page 25
P204E Output 4 Delay ON Time - Value 0-255 Seconds (Default = 0 Sec)	Page 25
P205E Output 5 Delay ON Time - Value 0-255 Seconds (Default = 0 Sec)	Page 25
P206E Output 6 Delay ON Time - Value 0-255 Seconds (Default = 0 Sec)	Page 25
P207E Output 7 Delay ON Time - Value 0-255 Seconds (Default = 0 Sec)	Page 25
P208E Output 8 Delay ON Time - Value 0-255 Seconds (Default = 0 Sec)	Page 25

Day Mode (CHIME) to Keypad Buzzer Timer

P209E Partition "A" Day Mode to KP Buzzer Time - Value 0-99 1/10 Seconds (Default ; 20 =2 Sec)	Page 24
P210E Partition "B" Day Mode to KP Buzzer Time - Value 0-99 1/10 Seconds (Default ; 20 =2 Sec)	Page 24

Output Day Mode Time

P211E Output 1 Day Mode ON Time - Value 0-99 1/10 Seconds (Default ; 20 =2 Sec)	Page 25
P212E Output 2 Day Mode ON Time - Value 0-99 1/10 Seconds (Default ; 20 =2 Sec)	Page 25
P213E Output 3 Day Mode ON Time - Value 0-99 1/10 Seconds (Default ; 20 =2 Sec)	Page 25

P214E	Output 4 Day Mode ON Time - Value 0-99 1/10 Seconds (Default ; 20 =2 Sec)	Page 25
P215E	Output 5 Day Mode ON Time - Value 0-99 1/10 Seconds (Default ; 20 =2 Sec)	Page 25
P216E	Output 6 Day Mode ON Time - Value 0-99 1/10 Seconds (Default ; 20 =2 Sec)	Page 25
P217E	Output 7 Day Mode ON Time - Value 0-99 1/10 Seconds (Default ; 20 =2 Sec)	Page 25
P218E	Output 8 Day Mode ON Time - Value 0-99 1/10 Seconds (Default ; 20 =2 Sec)	Page 25

Programming Exit Delays

P219E	Partition "A" Exit Delay Time - Value 0-255 Seconds (Default = 60 Sec)	Page 24
P220E	Partition "B" Exit Delay Time - Value 0-255 Seconds (Default = 60 Sec)	Page 24

Output Pulse Time

P221E	Output 1 Pulse Time - Value 0-99 1/10 Seconds (Default ; 20 =2 Sec)	Page 25
P222E	Output 2 Pulse Time - Value 0-99 1/10 Seconds (Default ; 20 =2 Sec)	Page 25
P223E	Output 3 Pulse Time - Value 0-99 1/10 Seconds (Default ; 20 =2 Sec)	Page 25
P224E	Output 4 Pulse Time - Value 0-99 1/10 Seconds (Default ; 20 =2 Sec)	Page 25
P225E	Output 5 Pulse Time - Value 0-99 1/10 Seconds (Default ; 20 =2 Sec)	Page 25
P226E	Output 6 Pulse Time - Value 0-99 1/10 Seconds (Default ; 20 =2 Sec)	Page 25
P227E	Output 7 Pulse Time - Value 0-99 1/10 Seconds (Default ; 20 =2 Sec)	Page 25
P228E	Output 8 Pulse Time - Value 0-99 1/10 Seconds (Default ; 20 =2 Sec)	Page 25

Two Trigger Timer

P229E	Two Trigger Timer - Value 0-255 Seconds (Default = 60 Sec)	Page 24
-------	--	---------

Duress Digit

P230E	Duress Digit - Value 1-9 (Default = 0 Duress Function Disabled)	Page 33
-------	---	---------

Radio Zone Detector Options

P231E	Options for Zone # 1 (Default= 0)	P231E-P238E Options	Page 26
P232E	Options for Zone # 2 (Default= 0)	1 = Crow AE Series Battery low	Page 26
P233E	Options for Zone # 3 (Default= 0)	2 = Crow AE Radio Reed Switch	Page 26
P234E	Options for Zone # 4 (Default= 0)	3 = Crow Merlin PIR (supervised signal ignored)	Page 26
P235E	Options for Zone # 5 (Default= 0)	4 = Crow Merlin PIR (supervised signal active)	Page 26
P236E	Options for Zone # 6 (Default= 0)	11 = Ness Devices battery Low	Page 26
P237E	Options for Zone # 7 (Default= 0)	12 = Ness Radio Reed Switch	Page 26
P238E	Options for Zone # 8 (Default= 0)	21 = Electronics Line Radio PIR	Page 26
		31 = Visonic K900 Radio PIR	Page 26
		32 = Visonic Powercode (supervised signal ignored)	Page 26
		33 = Visonic Powercode (supervised signal active)	

Radio Detector Supervised Timer

P239E	Radio Detector Supervised Timer - 0-255 Minutes (Default = 240 Minutes)	Page 27
-------	---	---------

Zone Inactivity Timer

P240E	Zone Inactivity Timer - 0-255 Hours (Default = 120 Hours)	Page 24
-------	---	---------

****Telephone Number Reporting Options****

P241E	Reporting Opts. Ph # 1 (Default= 2)	P241E-P244E Options	Page 39
P242E	Reporting Opts. Ph # 2 (Default= 2)	1 = Contact ID	Page 39
P243E	Reporting Opts. Ph # 3 (Default= 2)	2 = Domestic Dial	Page 39
P244E	Reporting Opts. Ph # 4 (Default= 2)	3 = Pager	Page 39
		4 = Speech Dialer	
		5 = 4+2 10pps (Handshake 1400/ Tone 1800)	
		6 = 4+2 10pps (Handshake 1400/ Tone 1900)	
		7 = 4+2 10pps (Handshake 2300/ Tone 1800)	
		8 = 4+2 10pps (Handshake 2300/ Tone 1900)	
		9 = 4+2 20pps (Handshake 1400/ Tone 1800)	
		10= 4+2 20pps (Handshake 1400/ Tone 1900)	
		11= 4+2 20pps (Handshake 2300/ Tone 1800)	
		12= 4+2 20pps (Handshake 2300/ Tone 1900)	
		13= 4+2 DTMF	

****Maximum Re-Tries per Telephone Number****

P245E	Maximum re-Tries for PH No. 1 - Value 0-99 (Default = 3)	Page 38
P246E	Maximum re-Tries for PH No. 2 - Value 0-99 (Default = 3)	Page 38
P247E	Maximum re-Tries for PH No. 3 - Value 0-99 (Default = 3)	Page 38
P248E	Maximum re-Tries for PH No. 4 - Value 0-99 (Default = 3)	Page 38

Page 39

****Auto-Answer Ring Count****

P249E	Auto-Answer Ring Count - Value 0-99 (Default = 8)	Page 46
--------------	--	---------

****Start of DTMF Remote Control Messages****

P250E	Start of DTMF Remote Control Messages - Value 0-99 (Default = 0)	Page 45
--------------	---	---------

****Programming Voice Board Messages****

P251E	Zone 1 Voice Message Number - (Default = 1)	Page 45
P252E	Zone 2 Voice Message Number - (Default = 1)	Page 45
P253E	Zone 3 Voice Message Number - (Default = 1)	Page 45
P254E	Zone 4 Voice Message Number - (Default = 1)	Page 45
P255E	Zone 5 Voice Message Number - (Default = 1)	Page 45
P256E	Zone 6 Voice Message Number - (Default = 1)	Page 45
P257E	Zone 7 Voice Message Number - (Default = 1)	Page 45
P258E	Zone 8 Voice Message Number - (Default = 1)	Page 45

****Miscellaneous Voice Board Messages****

P259E	Panic Alarm Voice Message Number - (Default = 1)	Page 45
P260E	Fire Alarm Voice Message Number - (Default = 1)	Page 45
P261E	Medical Alarm Voice Message Number - (Default = 1)	Page 45
P262E	Battery Low Voice Message Number - (Default = 1)	Page 45

Programming Entry Delays

P301E	Zone 1 Entry Delay Time - Value 0-255 Seconds (Default = 20 Sec)	Page 24
--------------	---	---------

P302E	Zone 2 Entry Delay Time - Value 0-255 Seconds (Default = 20 Sec)	Page 24
P303E	Zone 3 Entry Delay Time - Value 0-255 Seconds (Default = 0 Sec)	Page 24
P304E	Zone 4 Entry Delay Time - Value 0-255 Seconds (Default = 0 Sec)	Page 24
P305E	Zone 5 Entry Delay Time - Value 0-255 Seconds (Default = 0 Sec)	Page 24
P306E	Zone 6 Entry Delay Time - Value 0-255 Seconds (Default = 0 Sec)	Page 24
P307E	Zone 7 Entry Delay Time - Value 0-255 Seconds (Default = 0 Sec)	Page 24
P308E	Zone 8 Entry Delay Time - Value 0-255 Seconds (Default = 0 Sec)	Page 24

Output Reset Time

P311E	Output 1 Reset Time - Value 0-9999 Seconds (Default = 300 Sec)	Page 25
P312E	Output 2 Reset Time - Value 0-9999 Seconds (Default = 300 Sec)	Page 25
P313E	Output 3 Reset Time - Value 0-9999 Seconds (Default = 0)	Page 25
P314E	Output 4 Reset Time - Value 0-9999 Seconds (Default = 0)	Page 25
P315E	Output 5 Reset Time - Value 0-9999 Seconds (Default = 0)	Page 25
P316E	Output 6 Reset Time - Value 0-9999 Seconds (Default = 0)	Page 25
P317E	Output 7 Re set Time - Value 0-9999 Seconds (Default = 0)	Page 25
P318E	Output 8 Reset Time - Value 0-9999 Seconds (Default = 0)	Page 25

****Mains Fail Reporting Delay****

P319E	Mains Fail Reporting Delay - Value 0-9999 Seconds (Default = 600 Sec)	Page 46
--------------	--	---------

****Zone Contact ID Reporting Code****

P321E	Contact ID Code for Zone 1 (Default=130)	Page 41
P322E	Contact ID Code for Zone 2 (Default=130)	Page 41
P323E	Contact ID Code for Zone 3 (Default=130)	Page 41
P324E	Contact ID Code for Zone 4 (Default=130)	Page 41
P325E	Contact ID Code for Zone 5 (Default=130)	Page 41
P326E	Contact ID Code for Zone 6 (Default=130)	Page 41
P327E	Contact ID Code for Zone 7 (Default=130)	Page 41
P328E	Contact ID Code for Zone 8 (Default=130)	Page 41

****Keypad Panic Alarm Contact ID Reporting Code****

P329E	Keypad Panic (“Panic” or “1&3”) Contact ID Code (Default=120)	Page 41
--------------	--	---------

****Keypad Fire Alarm Contact ID Reporting Code****

P330E	Keypad Fire (4&6) Contact ID Code (Default=110)	Page 41
--------------	--	---------

****Keypad Medical Alarm Contact ID Reporting Code****

P331E	Keypad Medical (7&9) Contact ID Code (Default=100)	Page 42
--------------	---	---------

****DTMF Remote Control Codes****

P334E	DTMF Remote Control Code for Area “A” - 4 Digits (Default = 0)	Page 45
P335E	DTMF Remote Control Code for Area “B” - 4 Digits (Default = 0)	Page 45
P336E	DTMF Remote Control Code for Outputs - 4 Digits (Default = 0)	Page 45
P337E	DTMF Remote Control Code to Turn on Microphone - 4 Digits (Default = 0)	Page 45

Setting Real Time Clock

P401E	Real Time Hour/Minute - Value 0-2359	Page 33
P403E	Real Time Day of Week - Value 1-7 (1=Sunday, 2=Monday ,etc)	
P405E	Real Time Clock Date - Value 1-31	
P406E	Real Time Clock Month - Value 1-12	
P407E	Real Time Clock Year - Value 0-99	Page 33

Daylight Saving settings: NOT available in V8.64 panels and above)

P408E	Daylight Saving Start Sunday - Value 0-5 - Default = 1 (0=daylight saving start time disabled)	Page 33
P409E	Daylight Saving Start Month - Value 1-12 - Default = 10	
P410E	Daylight Saving Start Hour - Value 0-23 - Default = 2	
P411E	Daylight Saving End Sunday - Value 0-5 - Default = 3 (0=daylight saving end time disabled)	
P412E	Daylight Saving End Month - Value 1-12 - Default = 3	
P413E	Daylight Saving End Hour - Value 0-23 - Default = 2	
P414E	Daylight Saving is Active (If LED #1 is On, Daylight Saving is currently active)	

Test Call Time of Day

P402E	Test Call Hour/Minute - Value 0-2359	
P404E	Test Call Days of the Week - Value 1-7 (1=Sunday, 2= Monday, etc)	Page 46

Programming Telephone Numbers

P501E	Programming Telephone Number # 1 - Value 1-16 Digits	Page 38
P502E	Programming Telephone Number # 2 - Value 1-16 Digits	Page 38
P503E	Programming Telephone Number # 3 - Value 1-16 Digits	Page 38
P504E	Programming Telephone Number # 4 - Value 1-16 Digits	Page 38

Upload/Download Site Code Number

P505E	Upload/Download Site Code Number - 8 Characters (Default = None)	Page 46
-------	--	---------

Contact ID Account Codes

P506E	Contact ID Partition "A" Account Code Number - 4 Digits (Default = 0000)	Page 41
P507E	Contact ID Partition "B" Account Code Number - 4 Digits (Default = 0000)	Page 41

Zone Alarm 4+2 Reporting Code

P511E	4+2 Alarm Code for Zone 1 (Default=01)	Page 42
P512E	4+2 Alarm Code for Zone 2 (Default=02)	Page 42
P513E	4+2 Alarm Code for Zone 3 (Default=03)	Page 42
P514E	4+2 Alarm Code for Zone 4 (Default=04)	Page 42
P515E	4+2 Alarm Code for Zone 5 (Default=05)	Page 42
P516E	4+2 Alarm Code for Zone 6 (Default=06)	Page 42
P517E	4+2 Alarm Code for Zone 7 (Default=07)	Page 42
P518E	4+2 Alarm Code for Zone 8 (Default=08)	Page 42

System Tamper 4+2 Reporting Code

P519E	4+2 Alarm Code for System Tamper (Default=86)	Page 43
-------	---	---------

****Zone Alarm Restore 4+2 Reporting Code****

P521E	4+2 Alarm Restore Code for Zone 1 (Default=11)	Page 42
P522E	4+2 Alarm Restore Code for Zone 2 (Default=12)	Page 42
P523E	4+2 Alarm Restore Code for Zone 3 (Default=13)	Page 42
P524E	4+2 Alarm Restore Code for Zone 4 (Default=14)	Page 42
P525E	4+2 Alarm Restore Code for Zone 5 (Default=15)	Page 42
P526E	4+2 Alarm Restore Code for Zone 6 (Default=16)	Page 42
P527E	4+2 Alarm Restore Code for Zone 7 (Default=17)	Page 42
P528E	4+2 Alarm Restore Code for Zone 8 (Default=18)	Page 42

****System Tamper Restore 4+2 Reporting Code****

P529E	4+2 Alarm Code for System Tamper Restore (Default=87)	Page 43
-------	---	---------

****Miscellaneous Alarm 4+2 Reporting Codes****

P531E	Panic Alarm 4+2 Code (Default=88)	Page 43
P532E	Fire Alarm 4+2 Code (Default=89)	Page 43
P533E	Medical Alarm 4+2 Code (Default=90)	Page 43

****Miscellaneous Alarm 4+2 Restore Codes****

P534E	Panic Alarm Restore 4+2 Code (Default=91)	Page 43
P535E	Fire Alarm Restore 4+2 Code (Default=92)	Page 43
P536E	Medical Alarm Restore 4+2 Code (Default=93)	Page 43

****Mains & Battery 4+2 Reporting Codes****

P537E	Low Battery 4+2 Code (Default=94)	Page 43
P538E	Mains Failure 4+2 Code (Default=95)	Page 43

****Mains & Battery 4+2 Restore Codes****

P539E	Low Battery Restore 4+2 Code (Default=96)	Page 43
P540E	Mains Failure restore 4+2 Code (Default=97)	Page 43

****Armed by User # 4+2 Reporting Code****

P541E	4+2 Arm Code for User 1 (Default=41)	Page 43
P542E	4+2 Arm Code for User 2 (Default=42)	Page 43
P543E	4+2 Arm Code for User 3 (Default=43)	Page 43
P544E	4+2 Arm Code for User 4 (Default=44)	Page 43
P545E	4+2 Arm Code for User 5 (Default=45)	Page 43
P546E	4+2 Arm Code for User 6 (Default=46)	Page 43
P547E	4+2 Arm Code for User 7 (Default=47)	Page 43

P548E	4+2 Arm Code for User 8 (Default=48)	Page 43
P549E	4+2 Arm Code for User 9 (Default=49)	Page 43
P550E	4+2 Arm Code for User 10 (Default=50)	Page 43

****Disarmed by User # 4+2 Reporting Code****

P551E	4+2 Disarm Code for User 1 (Default=51)	Page 44
P552E	4+2 Disarm Code for User 2 (Default=52)	Page 44
P553E	4+2 Disarm Code for User 3 (Default=53)	Page 44
P554E	4+2 Disarm Code for User 4 (Default=54)	Page 44
P555E	4+2 Disarm Code for User 5 (Default=55)	Page 44
P556E	4+2 Disarm Code for User 6 (Default=56)	Page 44
P557E	4+2 Disarm Code for User 7 (Default=57)	Page 44
P558E	4+2 Disarm Code for User 8 (Default=58)	Page 44
P559E	4+2 Disarm Code for User 9 (Default=59)	Page 44
P560E	4+2 Disarm Code for User 10 (Default=60)	Page 44

****Armed by Radio Pendant User # 4+2 Reporting Code****

P561E	4+2 Arm Code for Radio User 1 (Default=61)	Page 44
P562E	4+2 Arm Code for Radio User 2 (Default=62)	Page 44
P563E	4+2 Arm Code for Radio User 3 (Default=63)	Page 44
P564E	4+2 Arm Code for Radio User 4 (Default=64)	Page 44
P565E	4+2 Arm Code for Radio User 5 (Default=65)	Page 44
P566E	4+2 Arm Code for Radio User 6 (Default=66)	Page 44
P567E	4+2 Arm Code for Radio User 7 (Default=67)	Page 44
P568E	4+2 Arm Code for Radio User 8 (Default=68)	Page 44

****Armed by "Arm" Button 4+2 Reporting Code****

P569E	4+2 Arm by "Arm" Button or Key-switch Code (Default=81)	Page 44
-------	---	---------

****Stay Mode Arming 4+2 Reporting Code****

P570E	4+2 Stay Mode Arming Code (Default=82)	Page 44
-------	--	---------

****Disarmed by Radio Pendant User # 4+2 Reporting Code****

P571E	4+2 Disarm Code for Radio User 1 (Default=71)	Page 44
P572E	4+2 Disarm Code for Radio User 2 (Default=72)	Page 44
P573E	4+2 Disarm Code for Radio User 3 (Default=73)	Page 44
P574E	4+2 Disarm Code for Radio User 4 (Default=74)	Page 44
P575E	4+2 Disarm Code for Radio User 5 (Default=75)	Page 44
P576E	4+2 Disarm Code for Radio User 6 (Default=76)	Page 44
P577E	4+2 Disarm Code for Radio User 7 (Default=77)	Page 44
P578E	4+2 Disarm Code for Radio User 8 (Default=78)	Page 44
P579E	4+2 Disarm by Arm or Stay Button or Key-switch (Default=83)	Page 44

****Duress Alarm 4+2 Reporting Code****

P580E	4+2 Duress Alarm Code (Default=84)	Page 45
-------	------------------------------------	---------

****Zone Bypassed 4+2 Reporting Code****

P581E	4+2 Bypass Message for Zone 1 (Default=21)	Page 42
P582E	4+2 Bypass Message for Zone 2 (Default=22)	Page 42
P583E	4+2 Bypass Message for Zone 3 (Default=23)	Page 42
P584E	4+2 Bypass Message for Zone 4 (Default=24)	Page 42
P585E	4+2 Bypass Message for Zone 5 (Default=25)	Page 42
P586E	4+2 Bypass Message for Zone 6 (Default=26)	Page 42
P587E	4+2 Bypass Message for Zone 7 (Default=27)	Page 42
P588E	4+2 Bypass Message for Zone 8 (Default=28)	Page 42

****Automatic Test 4+2 Reporting Code****

P590E	4+2 Automatic Test Code (Default=85)	Page 43
-------	--------------------------------------	---------

****Zone Bypassed 4+2 Restore Code****

P591E	4+2 Bypass Restore Message for Zone 1 (Default=31)	Page 42
P592E	4+2 Bypass Restore Message for Zone 2 (Default=32)	Page 43
P593E	4+2 Bypass Restore Message for Zone 3 (Default=33)	Page 43
P594E	4+2 Bypass Restore Message for Zone 4 (Default=34)	Page 43
P595E	4+2 Bypass Restore Message for Zone 5 (Default=35)	Page 43
P596E	4+2 Bypass Restore Message for Zone 6 (Default=36)	Page 43
P597E	4+2 Bypass Restore Message for Zone 7 (Default=37)	Page 43
P598E	4+2 Bypass Restore Message for Zone 8 (Default=38)	Page 43

Radio Zone Code Loading

P601E	Load Radio Code for Zone # 1	Page 26
P602E	Load Radio Code for Zone # 2	Page 26
P603E	Load Radio Code for Zone # 3	Page 26
P604E	Load Radio Code for Zone # 4	Page 26
P605E	Load Radio Code for Zone # 1	Page 26
P605E	Load Radio Code for Zone # 2	Page 26
P603E	Load Radio Code for Zone # 3	Page 26
P604E	Load Radio Code for Zone # 4	Page 26

Radio Pendant Code Loading

P611E	Load Radio Pendant Code # 1	Page 27
P612E	Load Radio Pendant Code # 2	Page 27
P613E	Load Radio Pendant Code # 3	Page 27
P614E	Load Radio Pendant Code # 4	Page 27
P615E	Load Radio Pendant Code # 5	Page 27
P616E	Load Radio Pendant Code # 6	Page 27
P617E	Load Radio Pendant Code # 7	Page 27
P618E	Load Radio Pendant Code # 8	Page 27

Restore All Factory Defaults

P620E	Restore All Factory Defaults	Page 33
-------	------------------------------	---------

Restore User Code Defaults

P621E	Restore User Code Defaults	Page 33
-------	----------------------------	---------

Restore Addresses 20-199 to Factory Defaults

P622E Restore Addresses 20-199 to Factory Defaults

Page 33

Restore Addresses 200-399 to Factory Defaults

P623E Restore Addresses 200-399 to Factory Defaults

Page 34

Restore Addresses 500-599 to Factory Defaults

P624E Restore Addresses 500-599 to Factory Defaults

Page 34

Restore All Radio Zone & Pendants to Factory Defaults

P625E Restore All Radio Zone & Pendants to Factory Defaults

Page 34

Clear Alarm Memory Buffer

P626E Clear Alarm Memory Buffer

Page 34

Walk Test Mode

P627E Walk Test Mode

Page 34

Write to EEPROM (DTU) Board

P628E Write to EEPROM (DTU) Board

Page 34

Read from EEPROM (DTU) Board

P629E Read from EEPROM (DTU) Board

Page 34

Contact ID Code Summary

In addition to the programmable Contact ID code assignments defined at P 321E - P331E there are a number of event codes with extensions pre-defined as listed below. This extensions list is for your reference only and can not be re-assigned.

Event	Code	Extension	Comment
Cabinet Tamper	137	000	Panel & Sat Tamper etc
Zone Tamper - Low (short circuit)	137	001 to 004	Zone Input 1-4
Zone Tamper - High (open circuit)	137	005 to 008	Zone Input 1-4
Keypad Panic (or 1&3)	120	001	At keypad #1
	through to	008	At keypad #8
Keypad Fire (4&6)	110	001	At keypad #1
	through to	008	At keypad #8
Keypad Medical (7&9)	100	001	At keypad #1
	through to	008	At keypad #8
Arm by "ARM key (Quick Arm)	408	000	
Arm by user code	401	001	User #1
	through to	010	user #10
Arm by Radio key	400	001	Radio User #1
	through to	008	Radio User #8
Arm by Command Control (remote set)	407	000	Command Control arm/disarm
Arm by Keyswitch	409	001	Area "A" Keyswitch Arm/Disarm
	409	002	Area "B" Keyswitch Arm/Disarm
Arm by Up/Download	407	000	Remote PC arm/disarm
Radio key Panic	120	001	Radio key pendant #1
		008	Radio key pendant #8
Radio PIR / Reed Switch Activation	130	001	Zone 1
	through to	008	Zone 8
System Battery Low	302	000	Control Panel Battery low
Mains Fail	301	000	230v mains to control panel lost
Radio PIR / Reed Switch Battery Low	384	001	Zone 1
	through to	008	Zone 8
Radio PIR Supervised Alarm	381	001	Zone 1
	through to	008	Zone 8
Zone Inactivity Alarm	391	001	Zone 1
	through to	008	Zone 8
Radio key Battery Low	384	021	Radio key #1
		022	Radio key #2
		023	Radio key #3
	through to	028	Radio key #8
TEST Calls	602	000	24 hour test
Zone Excludes	570	001	Exclude Zone 1
	through to	008	Exclude Zone 8
Phone Line Failure	351	000	Reported when line is restored
Monitor Mode (part set)	441	000	Arm by "Monitor" Button
		001	User 1
	through to	010	User 10
Duress Alarm	121	001	Duress at Keypad #1
	through to	008	Duress at keypad #8

Software changes with the POWER WAVE V8.61

(JAN 2002)

There have been a couple of changes to the panel to allow new features. These changes are documented below so that the differences between this version of the panel and earlier versions(software version V8.60 and below) can be identified.

The changes are;

- 1) A new event has been added to the event memory. When viewing the alarm events in memory mode there is a new "System" first event which is "the dialer failed to get a **kiss-off**". The event is displayed on the LED keypad as a system # 8 event (refer to the table on page 9).
- 2) A new feature has been added to the "STAY" mode arming sequence. When arming "STAY" mode all exit and entry delays will apply as programmed, however if the "Enter" button is pressed after arming "STAY" mode, then all **exit and entry delays will be cancelled** for that armed cycle making everything instant.
- 3) A new program address has been added, P169E. This address provides three new options, see page 28 for details on these new features.
- 4) The monitoring account numbers have moved from P332E (Area A account) & P333E (Area B account) to P506E (Area A) & P507E (Area B). This change has been made to allow the letters B,C,D,E & F to be programmed into the **account codes** (see page 38 for details).
- 5) There has been a change to the way 24 hour alarms can be reported if using Domestic or Voice alarm modes. Option # 6 at address P188E now can enable or fully **disable 24 hour alarm reports** in these two modes. In earlier software versions a 24 hour alarm would always report an alarm in Domestic or Voice mode if the alarm was armed but could also be programmed to report when disarmed as well. Now if option 6 is OFF there will be NO 24 hour alarms reported. If option 6 is ON then 24 hour alarms will ALWAYS report regardless of the Arm/Disarm state.
- 6) There has been a new option added at address P188E, option #7. This option now allows the ability to control whether **STAY** mode zone alarms will be reported via the dialer or not. If option 7 is turned ON, all STAY mode zone alarms will report via the dialer, if OFF then no STAY mode zone alarms will be sent. This option is essentially designed to work in combination with option 2 at P188E. If full reporting of the part set alarm state (Monitor Mode) is required then option 2 & 7 will be turned on. If alarms only are required for the part set mode then option 2 will be off and 7 on (this inhibits the arm/disarm report that may not be required in a residential situation). Finally, if both options 2 & 7 are off then the part set mode is purely a local audible alarm with not alarm reporting via the dialer.
- 7) There is a new zone configuration in the panel. This new option allows **zone doubling** to occur (4k7 & 8k2 Resistors) without the need to use the 2k2 tamper resistor. When using this configuration an open or short circuit on the input will result in both zones being un-sealed but NO zone tamper (refer to the drawing on page 5).
- 8) The **Radio Pendant Panic** would always cause the keypad buzzer to sound as well when the alarm was activated. The radio pendant panic alarm is now linked to the keypad panic alarms at address P175E. If all of the LEDS are Off at address P175E then any Keypad or Radio Pendant generated panic alarms will not cause the keypad buzzer to sound (silent panic alarm). If the LEDS are on at address P175E then the buzzer will sound when one of these alarms is generated (audible panic alarm).

Software changes with the PW8 V8.64 (July 2002)

The Daylight Savings adjustment (P408E-P414E) was removed to make room for the new Crow Fremlink Wireless PIR & Reed switch protocol (see address P231E-P238E). At the same time a User Code with Option 8 ON at addresses P21E-P30E can now also change the Telephone numbers and the Real Time Clock from Client Program Mode.

