

PowerWave – 16

16 Zone Control Panel Communicator

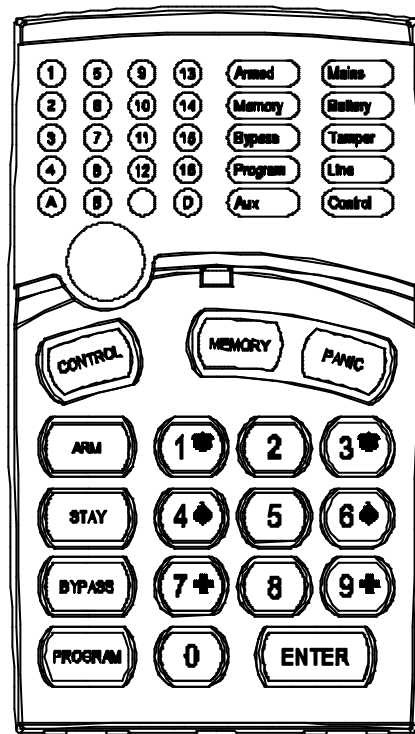
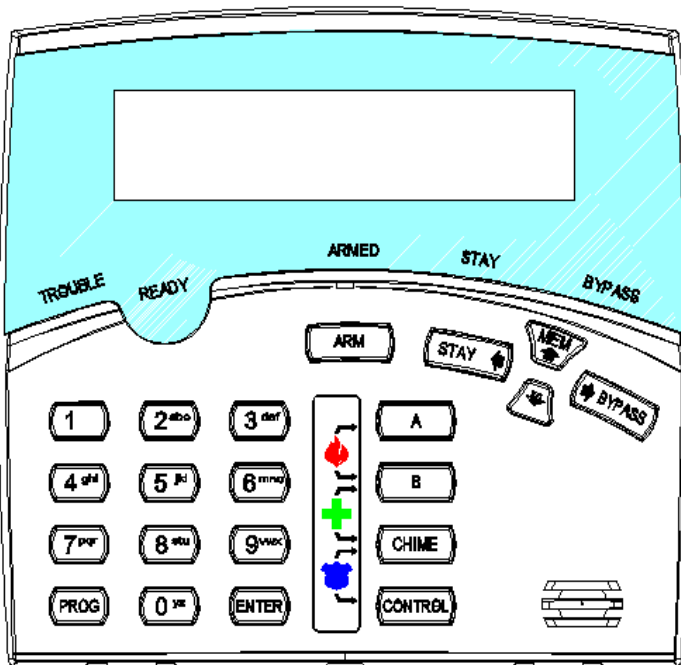

Installation and Programming Guide

CONTENTS

INTRODUCTION	4
PACKAGE CONTENTS	4
PW16 CABINET DETAILS	5
INPUTS	6
OUTPUTS	7
PANEL COMMUNICATION PORTS	7
PCB WIRING DIAGRAM	8
PW16 KEYPADS	9
KEYPAD INSTALLATION	10
KEYPAD FUNCTIONS	12
KEYPAD TAMPER	12
MEMORY DISPLAY CHART	13
INSTALLING RX-40 RADIO RECEIVER.....	15
INSTALLING SPEECH/DTMF UNIT.....	15
PROGRAMMING.....	16
USER CODE PROGRAMMING	17
OUTPUT OPTION	19
OUTPUT TIME ZONE	21
KEYPAD OPTIONS	22
PARTITION 'A' OPTIONS	24
PARTITION 'B' OPTIONS	24
PARTITION 'C' OPTIONS	24
MISC SYSTEM OPTIONS	30
ZONE PROGRAMMING	31
ZONE RESPONSE TIME SETTINGS.....	31
ENTRY/EXIT DELAYS	36
OUTPUT TIMERS	37
ACCESS CONTROL DOTL TIMERS	38
RADIO ZONE PROGRAMMING	38
RADIO ZONE OPTIONS	38
RADIO KEY PROGRAMMING	39
RADIO KEY OPTIONS	39
RADIO KEYS TO OUTPUTS	40
TIME ZONE PROGRAMMING	41
DAYLIGHT SAVING	42
DYNAMIC DIAGNOSTIC DATA	42
REAL TIME CLOCK PROGRAMMING.....	43
EVENT BUFFER PRINTING.....	44
RESET DEFAULTS	44
OUTPUT PARAMETER CLEAR FUNCTION	44
WALKTEST MODE	44
COMMAND CONTROL PROGRAMMING	44
COMMAND CONTROL OPERATION	47
COMMON REPORTING SCENARIOS.....	48
DIALLER REPORTING SCENARIOS	49
DIALLER REPORTING FORMATS	50
PROGRAMMING THE DIALLER	50
MAINS FAIL REPORTING DELAY.....	57
AREA SPECIFIC DIALLER REPORT OPTIONS	56
CONTACT ID ASSIGNMENTS	55
UPLOAD/DOWNLOAD OPTIONS.....	58
PROGRAMMING 4+2 EVENT CODES	58
CONTACT ID CODE SUMMARY	58
PROGRAM ADDRESS SUMMARY	59

INTRODUCTION

This Crow PowerWave Version V6 alarm control panel has been designed to provide the most requested features for both the installer & the end-user. These features include ease of installation, ease of programming and user friendly operation all in a package which is reliable, functional and attractive.

Utilising many years of experience in the security industry and implementing valuable feedback, we are proud to provide you with a new generation of alarm control panel. The PowerWave V6 is an alarm system which brings you the quality and features which you deserve at an affordable price. In addition to the the advanced design, only the highest quality components have been used in the production of this PowerWave panel to ensure the highest degree of reliability.

This manual will guide you through the installation and programming of your PowerWave alarm panel. For additional information regarding the operation instructions and options, please refer to the enclosed "PowerWave User's Guide".

PACKAGE CONTENTS

This Crow PowerWave package should contain the following items;

- 1 x PowerWave controller PCB
- 1 x PowerWave new generation backlit keypad
- 1 x PowerWave keypad zone list
- 1 x PowerWave Users Guide
- 1 x PowerWave Housing
- 1 x PowerWave mains transformer (15VA/25VA)
- 1 x PowerWave hardware accessory pack including:
 - 1 x PowerWave installation & programming guide
 - 1 x Spare 1.5A fuse
 - 2 x Housing lid screws
 - 10 x 2k2 (red, red, red) end of line resistors
 - 10 x 4k7 (yellow, purple, red) end of line resistors
 - 10 x 8k2 (grey, red, red) end of line resistors

PLASTIC HOUSING DETAILS

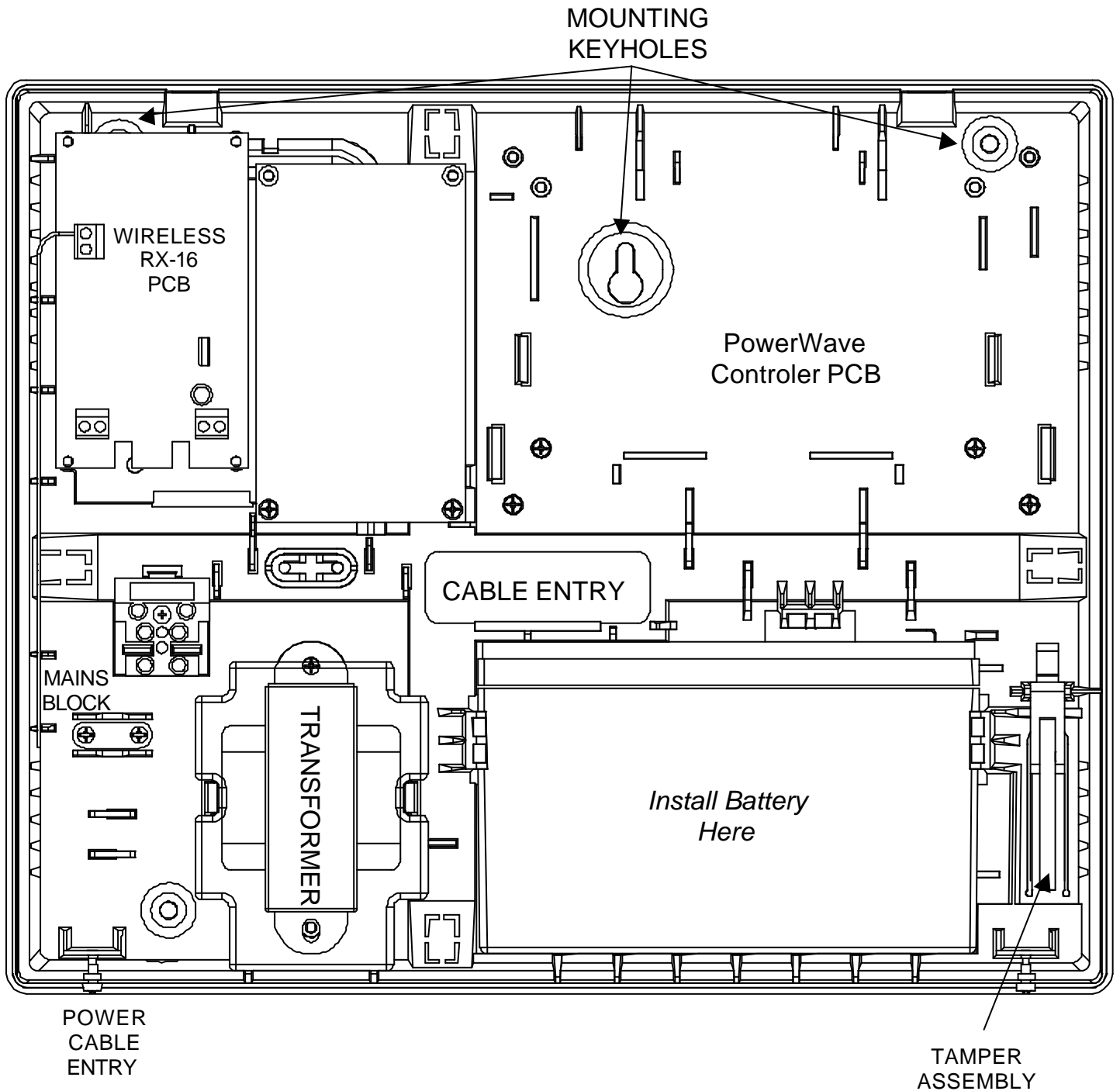

INPUTS

The Elite V6 has 10 separate programmable monitored analogue inputs,

- 8 x Programmable, multi-state detection inputs
- 1 x Programmable tamper input
- 1 x Programmable keyswitch input

Each input must be terminated with a short or the appropriate combination of end-of-line resistors, depending upon the programmed configuration.

ZONE INPUTS - Each of the 8 zone inputs can be independently assigned one of the following configuration options;

- Type 1(8Z) 8 Zone Short circuit input No-End-of-Line (EOL).
- Type 2(8Z) 8 Zone Single-End-of-Line 2k2 (EOL) with no tamper.
- Type 3(16Z) 16 Zone Double-End-of-Line (EOL) No Tamper.
- Type 4(16Z) 16 Zone Double-End-of-Line (EOL) With open & short circuit Tamper.

The following table shows end-of-line resistor configurations. The reference to LEDs in bold below relate to the program option setting at addresses P310E & P319E. The options 1-8 at addresses P310E & P319E relate to zone inputs 1-8. If an input is set to EOL at address P319E then it relates to the single zone being a 2K2 resistor but if

Zone Type	Low Zone	Hi Zone	Tamper
Type 1(8 Zone No EOL) P310E LEDs Off, P319E LEDs Off	N/A (Short circuit)	None	None
Type 2(8 Zone EOL, No Tamper) P310E LEDs Off, P319E LEDs On	2k2	None	None
Type 3(16 Zone EOL, No Tamper) P310E LEDs On, P319E LEDs Off	4k7	8k2	N/A
Type 4(16 Zone EOL, with Tamper) P310E LEDs On, P319E LEDs On	4k7	8k2	2k2

Type 1 (8 Zones, Short Circuit)

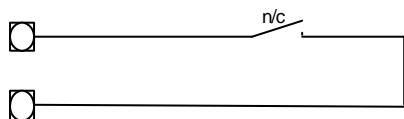

Type 2 (8 Zones, 2k2 EOL, No tamper)

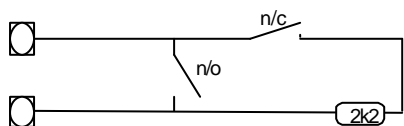

Type 3 (16 Zones, 4k7 & 8k2 EOL with No tamper)

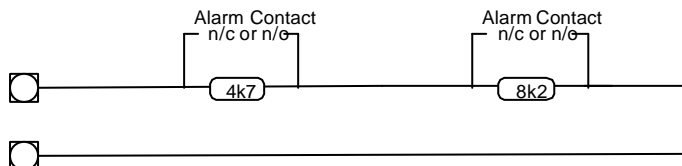

Type 4 (16 Zones, 4k7 & 8k2 EOL, 2k2 EOL for tamper)

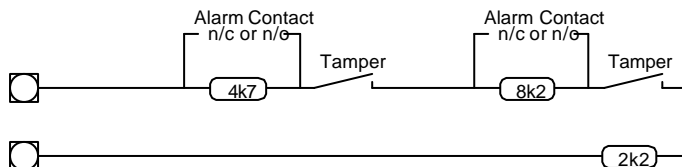

LED at Address P310E (Zone Doubling) ↓	LED at Address P319E (EOL or Tamper) ↓
LED # 1 Off = Zone 1 only On = Zones 1 & 9	LED # 1 Off = No EOL On = Zone EOL or Tamper
LED # 2 Off = Zone 2 only On = Zones 2 & 10	LED # 2 Off = No EOL On = Zone EOL or Tamper
LED # 3 Off = Zone 3 only On = Zones 3 & 11	LED # 3 Off = No EOL On = Zone EOL or Tamper
LED # 4 Off = Zone 4 only On = Zones 4 & 12	LED # 4 Off = No EOL On = Zone EOL or Tamper
LED # 5 Off = Zone 5 only On = Zones 5 & 13	LED # 5 Off = No EOL On = Zone EOL or Tamper
LED # 6 Off = Zone 6 only On = Zones 6 & 14	LED # 6 Off = No EOL On = Zone EOL or Tamper
LED # 7 Off = Zone 7 only On = Zones 7 & 15	LED # 7 Off = No EOL On = Zone EOL or Tamper
LED # 8 Off = Zone 8 only On = Zones 8 & 16	LED # 8 Off = No EOL On = Zone EOL or Tamper

INPUTS Cont.

KEYSWITCH - This input can be used to control the panel via a keyswitch, digital keypad or similar. This is a multi-state input which can be end-of-line configured in the same way as the 8 zone inputs. These multiple end-of-line configurations will produce either set/unset or stay mode on/off on an individual partition basis.

TAMPER - A 24Hr tamper circuit is available for monitoring tamper status of detectors, junction boxes, cabinets and satellite sirens etc. This Tamper circuit is programmable with 2 options (P211E1E) either normally closed loop or 2k2 EOL supervision. The tamper circuit must be terminated with an end-of-line resistor if 2k2 EOL supervision is selected. The activation events and outputs for this tamper circuit are mapped in the same manner as for detection zones 1-8.

AC - Connect the two low voltage wires (no polarity) from the transformer to the terminals marked AC on the Elite PCB. The Elite includes a Telepermitted transformer rated at 1.4 amps at 17 volts and incorporates an inbuilt thermal protection fuse.

EARTH - Always connect the mains earth to the appropriate terminals on the mains terminal block in the steel cabinet. Also connect a lead from this earth point to the terminal marked "Earth" on the Elite PCB.

BATTERY - Connect a sealed lead acid rechargeable 12V d.c. battery to these red and black battery leads. The minimum recommended battery capacity is 7 amp hours. Battery charge current at these terminals is limited to 300mA maximum.

LINE IN - This pair of terminals is used to connect the Elite to the incoming telephone line from the street. The communicator uses this line for reporting.

LINE OUT - This pair of terminals is used to connect telephones and other communication equipment to the incoming phone line via the Elite controller. The telephone line is passed through the Elite controller to ensure that the line is available to the controller when it is required. Full details regarding the communicator can be found in a separate section.

OUTPUTS

12 VOLT OUTPUTS - There are four 12 volt dc outputs available on the Elite PCB. They are fuse protected suitable for powering detectors, sirens and other external devices. These outputs are marked 12v and 0v, and are supplied by fuses F1 and F2. A maximum total load of 1 amp may be drawn from these terminals. The fourth set of fused (F2) 12V terminals are found adjacent to the keypad comms clock and data terminals.

OUTPUTS 1 & 2 - These fully programmable, high current, open collector (high-going-low) type FET outputs are capable of switching up to **1.5A @ 12V d.c.** These 2 outputs are normally set as switched outputs, providing power for 12v sirens or piezos. However if options 2 or 3 are turned Off at address P210E (2 relating to output 1 and 3 relating to output 2) then the output becomes a siren output designed to drive an 8 ohm 10 watt horn speaker with a modulated siren tone. **Also if a horn speaker is connected to Output 1 you may select the listen-in feature to this output at address P213E as well so that the dialling sequence can be heard at the speaker.**

OUTPUTS 3,4,5,6,7&8 - These are low current, open collector (high-going-low) type outputs capable of switching no more than **100mA**. Like Outputs 1 & 2 they are fully programmable.

NOTE: - *Connecting devices which draw current in excess of 100mA to outputs 3,4,5,6,7&8 may cause permanent damage to the Elite controller output concerned.*

COMMUNICATION PORTS

KEYPAD PORT - The terminals marked *POS*, *NEG*, *CLOCK*, & *DATA* make up the communications port which the keypads and other intelligent field devices use to talk to the Elite controller. The terminals are connected to corresponding terminals on the remote devices. The "listen" terminal is only used by the keypads and utilises a fifth wire to provide a communicator listen in facility. This feature is particularly useful when servicing monitoring faults.

SERIAL PORT - The serial port is for the connection of the RS232 serial board, the optional VOICE Board, DTMF Board or the optional DTU (data transfer) board. The serial board allows for printing of the 255 event buffer to a serial printer or for pc direct up/down load connection. The VOICE board allows for alarm reporting and remote control with speech messages, the DTMF board allows for remote control using tones, both from a remote telephone. The DTU board to allows program back-up and re-instatement.

PCB WIRING INSTRUCTIONS

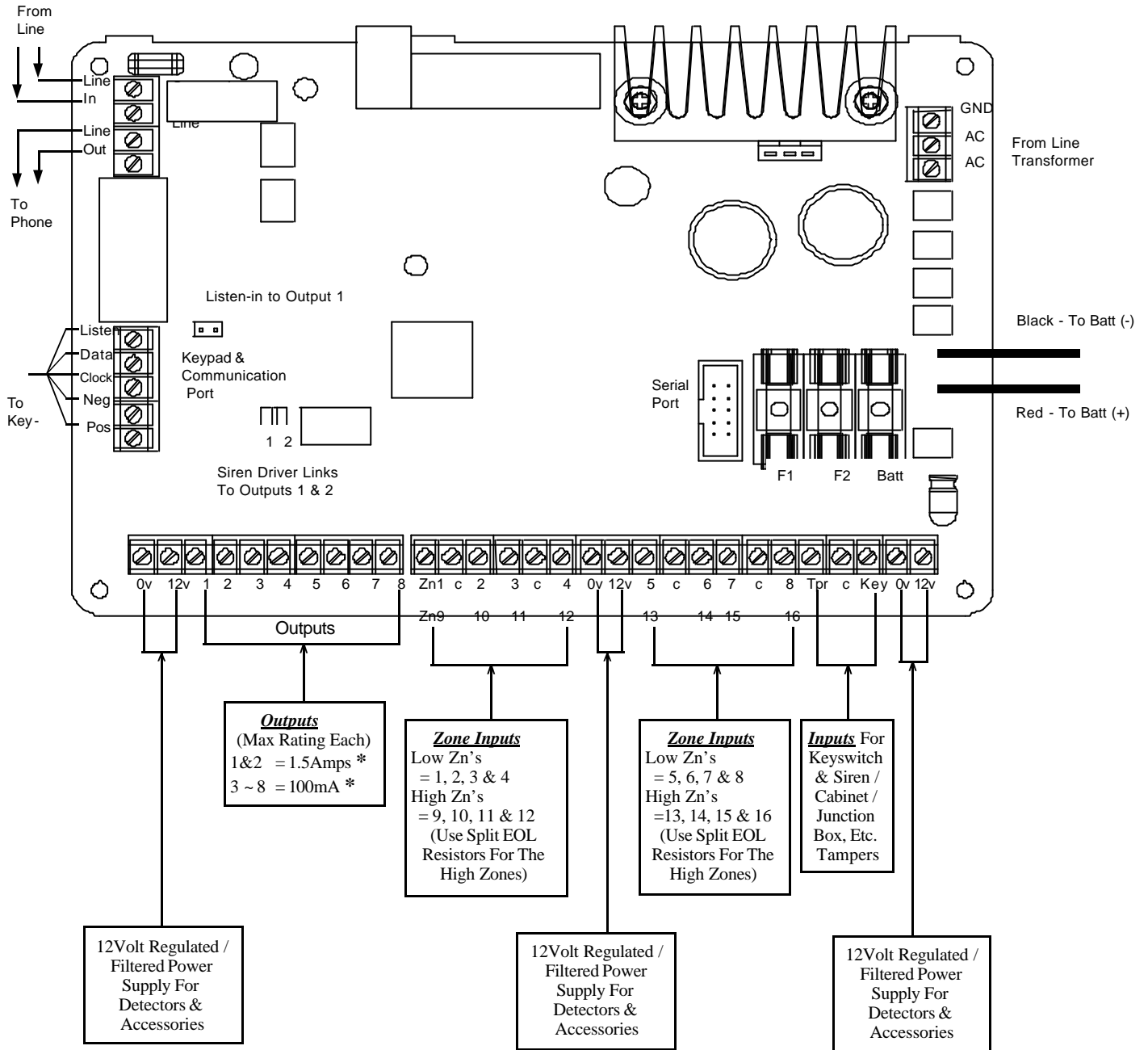

* = AC Plug Pack / Battery Capacity & Fuse ratings Permitting

PW-16 KEYPAD OPTIONS

LCD-KEYPAD

- ✓ Multiple language versions
- ✓ LED indicators ... READY , ARMED, TROUBLE....
- ✓ 3 KeyPad activated alarms FIER,MEDICAL, PANIC
- ✓ Audible feedback of correct key entries, pre-alert , system trouble
- ✓ Backlit keypad and display with boost control
- ✓ keypad tone control
- ✓ Large 32-character LCD display
 - system menus and prompts
 - trouble indications
 - time &date clock
 - viewable event buffer
 - all system parameters programming
 - customizable zone labeling

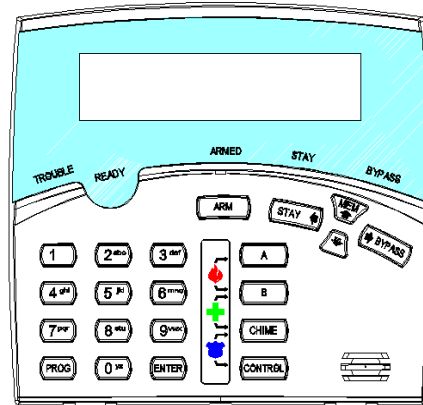

LED-KEYPAD

- ✓ LED indicators ... ARMED, TROUBLE....
- ✓ 4 KeyPad activated alarms FIER,MEDICAL, PANIC
- ✓ Audible feedback of correct key entries, pre-alert , system trouble
- ✓ Backlit keypad
- ✓ Viewable event buffer
- ✓ All system parameters programmable

KEYPAD INSTALLATION

INSTALLATION

Separate the two keypad halves by **carefully** inserting a small screwdriver into the release slots on the bottom edge of the keypad front half and applying a gentle pressure. This will release the bottom edge of the housing enough for you to unclip the top.

Screw the base to the wall using the mounting holes provided. These holes will match the standard single switch plate spacing. Ensure the base is mounted right side up. It is marked with the word "TOP" to aid orientation. When fixing the base to the wall make sure the top of the screw heads will not touch or short out the underside of the PCB when the top half of the keypad is reinstalled. Bring the cables through the centre of the base.

Connect the 4 or 5 wires to the 5 way terminal block on the rear of the keypad PCB making sure to match the cables up with the terminals as marked on the control panel's keypad port. The 5th wire is connected from the "LIN" terminal of the keypad to the "Listen" terminal of the Elite PCB keypad port.

Once the cables have been terminated and the required address allocated (see section below) clip the front half of the keypad onto the base by first engaging the clips at the top edge and then close the front down and clip it in at the bottom. Now stick the zone list provided to the inside of the hinged lid.

WIRING

The PowerWave keypad connects to the Powerwave Controller via a 4 or 5 wire data & power connection. A maximum of 8 LED keypads can be connected, each wired in parallel. A 5th wire may be used to provide a "Listen-in" facility at the keypad when an PW communicator panel is being used.

The maximum recommended cable using standard 0.2mm security cable is 50m. Cable runs exceeding this distance may require 0.5mm cable. Always use good quality cable. Some installations may require data cable to ensure data integrity in noisy sites.

User information :

**Keypad LCD — Power Wave CR16M-LCD Keypad
Users' Operating and Programming Guide**

**Keypad LED — Power Wave – 16
Users' Operating and Programming Guide**

KEYPAD TAMPER OPTION SETTING

Switch marked D used to Enable and Disable the Keypad Tamper option:

To disable keypad tamper, change switch D to ON position.

To enable keypad tamper, change switch D to OFF position.

LED KEYPAD ADDRESS ASSIGNMENT

Each of the 8 possible LED keypads which are able to be connected to your PW4 panel must be addressed individually to avoid BUS conflicts when multiple users are operating different keypads simultaneously. As default, each keypad comes addressed as #1 (Switches A B and C at ON position).

To assign a keypad as address #2, change switch A to OFF position.

To assign a keypad as address #3, change switch B to OFF position.

To assign a keypad as address # 4, change switches A and B to OFF position.

INDIVIDUAL KEYPAD ADDRESS SETTING

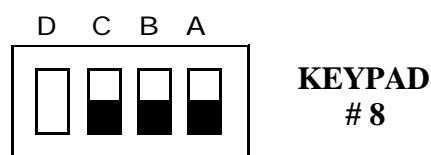
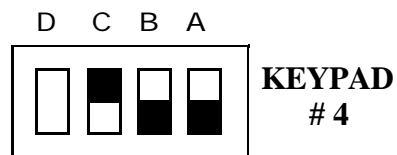
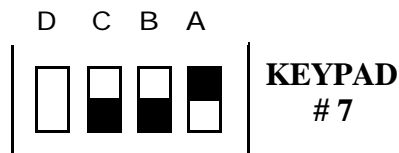
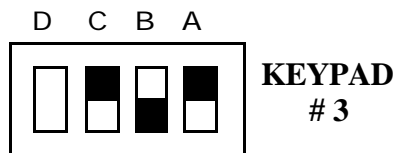
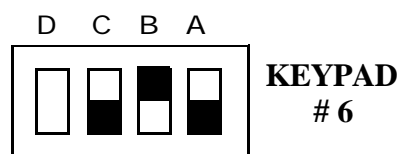
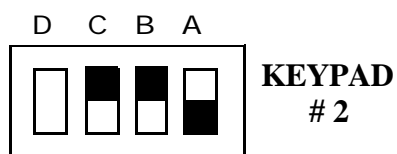
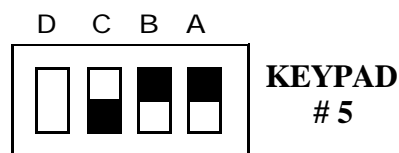
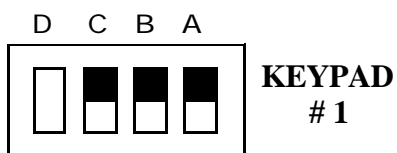

When the Elite keypad is displaying numeric values in program mode it uses the zone LEDs 1-8 to indicate a value of 1-8 and to maintain consistency with the 8 zone LED keypad, the panel uses the "A" LED to indicate a "0" and the "B" LED to indicate a "9".

"A" = 0, "B" = 9.

LIGHT	OFF	ON STEADY	FLASHING
BATTERY		Normal	Battery Low
MAINS		Normal	Mains Power Off
ARMED	Unused	Unused	Unused
MEMORY	Normal	Memory Display	New Event to View
BYPASS	Normal	Bypass Mode Active	Zone(s) Bypassed
PROGRAM	Run Mode	Client Program Mode	Installer Program Mode
TAMPER	Normal	Tamper still Active	New Tamper Alarm
LINE	Normal	Communicating	Line Fail or no Kissoff
AUX.	Unused	Unused	Unused
CONTROL	Control Function Off	Control Function On	DOTL Override On
ZONES 1-16	Zone Secure	Zone Violated	Zone in Alarm
A	Partition A Disarmed	Partition A Armed	Partition A in Stay Mode
B	Partition B Disarmed	Partition B Armed	Partition B in Stay Mode
C	Partition C Disarmed	Partition C Armed	Partition C in Stay Mode
D	Unused	Unused	Unused

KEYPAD FUNCTIONS

The PW LED Keypad consists of; an 18 button, backlit silicone rubber keypad, 30 LED indicators and an internal piezo buzzer housed in a modern white plastic housing. The plastic housing has a hinged front lid to cover and protect the rubber buttons when not in use. All the electronics are contained on a single circuit board inside the housing.

Because the keypads communicate with the controller using data, the cable run from panel to keypads is secure against tampering. For this reason there is no tamper switch on the keypad assembly. Access to the keypad electronics will not disarm the panel.

BUTTONS

The 18 silicone rubber buttons are used for the following functions.

In normal operating mode the numeric keys are used for entering Access Codes. In Program Mode the numeric keys are used for entering program addresses & new values.

The buttons with text labels are used as function buttons and select the options indicated by the text and normally precede other button presses, e.g. to enter Bypass Mode press <**BYPASS**> and a two digit numeric key entry corresponding to the zone number you wish to be excluded eg "01" for Zone # 1, "09" for Zone # 9 and "15" for Zone # 15.

The **PROGRAM** Key is used to prefix option selections in the program modes e.g.<**PROGRAM**> 24 <**ENTER**> selects User Code 24 when in either of the two program modes. The **PROGRAM** key is also used prior to a Master or Installer Code to enter one of the program modes from normal operating mode.

The **ENTER** Key is used after entry of a sequence of numbers (eg entry of a User code to Arm or Disarm the system). As a User code can be 1-6 digits in length, the panel will not accept a code entry until the Enter key is pressed.

The **CONTROL** button, if enabled, is used to produce an output without an alarm event. This control output can be used to operate other external devices such as garage door openers, door locks, lights or other options as required.

LED INDICATORS

The LED indicators are used to display system conditions including Zone status, Battery state, Tamper etc. Please refer to the LED table on page 12 for a full explanation of the conditional displays.

KEYPAD TAMPER (wrong code alarm)

A wrong code or **Keypad Tamper** alarm is generated by the Elite after 4 consecutive invalid code entries. The controller will not "Lock-Out" the keypad at this point but simply create an alarm condition that may be reported to a monitoring company via the dialer. Entry of a valid user code will reset the Keypad Tamper alarm however, the alarm event will be written into memory and the keypad memory light will be flashing indicating the presence of a new memory entry.

VIEW MEMORY MODE

This PW version 6.20 and up alarm panel has an event memory which stores the most recent events (up to 255 events) including all alarm events, all system events such as mains failure etc as well as settings. This event memory is displayed via the standard keypad with the most recent event shown first and subsequent events following in descending order from newest to oldest.

The "MEMORY" light will flash on and off when there is a new event in memory which has not been viewed. To stop the "MEMORY" light flashing, simply press the MEMORY button and the event memory will be flashed back to you with the most recent event shown first. Each event is separated by a beep tone.

Current System Alarms

When viewing the memory event buffer at the keypad by pressing the "MEMORY" button, the first thing that will always be displayed is the Current System Alarms that are still present. The Current System Alarms are indicated by the Memory/Mains & Battery LEDS being on plus a zone LED from 1-8 to indicate the system alarm/s present. If no Zone LED's are on at this time, it means that there are no current system alarms. If a zone LED or LED's are On then this indicates system alarms that have not yet cleared. The zone LED's 1-8 are pre-defined as to what system alarm they will display. These system alarm indications are shown in the table below. Following the display of current system alarms the panel will then sequence through the 255 historical memory events starting at the most recent event. The second table shows the alarm events that can be displayed in memory mode and what indicators

CURRENT SYSTEM ALARMS			
LED # 1	Battery Low	LED # 5	Radio Pendant Battery Low
LED # 2	Mains or 12V Fuse Failure	LED # 6	Supervised Detector Failure
LED # 3	Telephone Line Failure	LED # 7	Zone Inactivity Timeout
LED # 4	Radio Detector Battery Low	LED # 8	Dialler Kiss-off Failure

HISTORICAL EVENT DISPLAY CHART			
EVENT	DEVICE	INDICATOR	STATUS
ACTIVATION	Zones 1-16	LED's 1-16	On Steady
EXCLUDE	Zones 1-16	Bypass LED's 1-16	On Steady On Steady
DETECTOR TAMPER (SHORT CIRCUIT)	Zones 1-8	TAMPER LED's 1-8	Flashing On Steady
DETECTOR TAMPER (OPEN CIRCUIT)	Zones 9-16	TAMPER LED's 9-16	Flashing On Steady
CABINET TAMPER	Cabinet or Satellite Siren	TAMPER	Flashing
WRONG CODE ALARM	Code Tamper at Keypad #	TAMPER LED's 1-8	On Steady On Steady
CROW KEYPAD TAMPER SWITCH ACTIVATED	Keypad Tamper Alarm at Keypad #	TAMPER LED's 1-8	On Steady On Steady
LOW BATTERY	Controller Battery	BATTERY	Flashing
MAINS FAILURE	Controller Mains Supply	MAINS	Flashing
FUSE FAILURE (F1 or F2)	Controller on-board fuses	MAINS	Flashing

VIEW MEMORY MODE

HISTORICAL EVENT DISPLAY CHART-Continued			
EVENT	DEVICE	INDICATOR	STATUS
LOW BATTERY-ZONE	Radio Zone Zone 1-16	BATTERY LED's 1-16	Flashing On Steady
LOW BATTERY-PENDANT	Radio Key User 1-20	BATTERY LED's 1-16,17,18,19,20	Flashing On Steady
ZONE INACTIVITY TIMEOUT	Zone 1-16	LED's 1-16 TAMPER CONTROL	On Steady Flashing Flashing
SUPERVISED RADIO TIMEOUT	Zone 1-16	LED's 1-16 TAMPER BYPASS	On Steady Flashing Flashing
DURESS ALARM	Duress Alarm (at Keypad #)	TAMPER LINE LED's 1-8	Flashing Flashing On Steady
KEYPAD PANIC	Panic Alarm at Keypad	LINE LED's 1-8	Flashing Flashing
KEYPAD FIRE	Fire Alarm at Keypad	LINE CONTROL	Flashing Flashing
KEYPAD MEDICAL	Medical Alarm at Keypad	LINE BYPASS	Flashing Flashing
ARMED	Area "A" Armed	"A"	On Steady
ARMED	Area "B" Armed	"B"	On Steady
ARMED	Area "C" Armed	"C"	On Steady
STAY MODE ON	Area "A" in Stay Mode	"A"	Flashing
STAY MODE ON	Area "B" in Stay Mode	"B"	Flashing
STAY MODE ON	Area "C" in Stay Mode	"C"	Flashing
TELEPHONE LINE FAIL	Panel Dialer	LINE	On Steady
EXCESSIVE RE-TRIES	Panel Dialer	LINE LED 1	On Steady On Steady
FAILURE TO GET A KISSOFF	Panel Dialer	LINE LED 2	On Steady On Steady
WALKTEST MODE	Manual Walk-test Mode	MAINS BATTERY LINE LED's 1-16	On Steady On Steady On Steady On Steady

INSTALLATION OF RX-40 RECEIVER

The PW16 is fully high level compatible with the RX-40 radio receiver. The addition of this receiver will add wireless capability to your system in the form of wireless PIR detectors, Wireless Radio key transmitters and wireless reed switch transmitters. The RX-16 receiver connects to the same communications port as the keypads and can be installed, either inside the cabinet, or if preferred, may be installed at a remote location. The RX-16 is available in 2 frequencies, 303.875mhz or 433.92mhz. Multiple RX-16 receivers may be connected to the panel to increase the effective range if required.

The RX-16 receiver requires 4 cores and can successfully be run in 0.2mm unscreened cable over a distance of up to 100metres. Like the keypads the RX-16 has 12v and 0v terminals for connection to the 12v supply and CLK and DATA terminals for connection to the communications bus.

The green LED fitted to the RX-16 receiver will indicate when the unit is in "Learn" mode (LED Flashing) or when it is receiving an actual radio transmission (On Steady)

INSTALLATION OF VOICE or DTMF BOARD

The PW16 control communicator can also be fitted with a 90 second Voice Board or DTMF module. The Voice board stores either alarm event messages for Voice dial monitoring and /or status messages for use with Command Control. The DTMF board provides decoding of keypad numeric entries from a remote telephone. The Elite V6 Voice or DTMF Boards are installed directly onto the motherboard via the "SERIAL" socket.

Installation procedure for the Voice or DTMF Board module is as follows.

- 1 Power-down the Elite fully before starting the installation procedure.
- 2 Carefully plug the Voice or DTMF Board into the SERIAL socket.
- 3 Power-up the Elite.

Once you have installed the Voice Board you can record your personalised speech messages into the module with the speech programmer. The programmer plugs onto the 10 way strip connector on the voice board and must be installed with the Brown wire towards the PW control board heatsink. Some programmers are fitted with a polarisation pin on the connection socket which will prevent incorrect insertion however, some earlier units are not.

To record your messages once the programmer is installed, first press the reset button on the side of the Voice Board, then hold the programmer about 10 cm away from the mouth and speak clearly at normal level into the microphone while holding down the "REC" button. When you reach the end of your message release the REC button. (NOTE: Each individual message must be longer than 2 seconds duration). When recording your voice alarm message, you must ensure that you clearly identify the origin of the call. You can play the message back through the programmer by first pressing the reset button then by pressing the "PLAY" button momentarily. Because the Elite V6 control communicator has the ability to store multiple alarm event and control voice messages, you must store individual messages at what is known as recording slots within the Voice Board. These recording slots are recorded sequentially, one message starting where the other finishes. Every time you press and release the REC button of the programmer, you create an end of message marker. These markers are used to define the recording slots within the Voice Board and can be of varying length according to each message duration.

To re-record a message you must first press the "RESET" button on the speech module to get back to recording slot #1. Once you are at slot #1 you can re-record your messages in order as required.

NOTE: When recording multiple messages you only press the "RESET" button once at the beginning then record all messages sequentially as stated above. When you have finished recording all of your messages you can then press the "RESET" button to allow play-back of the recording messages for verification purposes.

When you have finished recording your alarm messages, unplug the programmer and the process is complete.

PROGRAMMING YOUR PowerWave

ACCESS TO INSTALLER PROGRAMMING ON POWER UP

When **power is applied** to the controller for the first time, **with the panel tamper input open and none of the Areas either fully Armed or in Stay mode**, the panel will inhibit tamper alarms and ready the panel to enter PROGRAM Mode(unless the Installer Lock-out option P210E7E has previously been enabled). At this point you can go to any keypad which is connected to the panel and;

Press –"**PROGRAM**"–"**ENTER**"

which will automatically put that keypad into full Program mode, Program LED Flashing.(NOTE:Only one keypad can be in Program mode at any time)

ACCESS TO PROGRAM MODES FROM RUN MODE

Before you can enter program mode from the normal Run Mode, the panel must be unset and not in stay mode. Then;

Press <**PROGRAM**> - <Code 1(or Master Code)> - <**ENTER**>

Program light steady

Note: Default Master Code (Code 1) is 1,2,3

You are now in Client Program Mode. When you are in Client programming mode you have access to program addresses P1E to P24E (user code programming). To **Enter Installer Program Mode from Client Program Mode;**

Press <**PROGRAM**> - <Install Code> - <**ENTER**>

Program light flashing

Note: Default Install Code (P99) is 0,0,0,0,0,0

By default the installer can go directly to Installer Program Mode from Normal Run mode provided No Areas are Armed or in Stay Mode. The Installer Mode direct option can be disabled at address P210E Option 7.

HOW TO PROGRAM

The programming sequence always follows this pattern;

<**PROGRAM**> - <1,2 or 3 digit address> - <**ENTER**>

3 short beeps if OK - 1 long beep if error

The leds will display current value or status

Enter the new value or option

<New Value> - <**ENTER**>

3 short beeps if OK - 1 long beep if error

An example of programming is shown below. Here we are programming User Code 23 (P23E) with the code number of 2580.

P 23 E 2,5,8,0 E

In this example the <P> represents the **PROGRAM** key, <23> represents the actual program address, 2580 is the data and <E> represents the **ENTER** key.

TO CLEAR PROGRAM INFORMATION (From Install Mode Only)

There are multiple options available for clearing program information (Reset to defaults). These are detailed on page 38.

e.g.To reset User Codes 1-24 (P 720E)

Press <**PROGRAM**> - 720 - <**ENTER**>

3 beeps - Program light flashing

After resetting the various defaults, all options associated with that function (eg User Code Defaults P720E) will be set to the default values shown in the Program Summary at the rear of this manual. The default settings have been chosen to simplify the installation process by minimising the amount of programming necessary to get the system fully functional.

TO EXIT PROGRAM MODES

To exit program modes when you have finished programming:

Press <**PROGRAM**> - <**ENTER**>
Program light goes out

The panel is now back in normal Run Mode, any program changes you have made will have replaced previous values and be in effect.

Note: During programming Tamper and 24 hour alarms are disabled which allows quiet access to the panel, detectors and satellite siren units etc. On exiting program mode, all inputs are scanned and if any tamper or 24Hr alarms are present an activation will occur.

Note: Where there are multiple options at one address, options 0 & 9 have been reserved. Entering a 0 at the address will turn all options off whereas entering a 9 will turn all options on.

PROGRAMMING USER CODES

P1E to P50 E

There are 51 codes available in the PowerWave16 , 50 user codes and 1 install code. The user codes are located in addresses 1-50. By default, **Code 1 is the Master Code** because it has full access to enter program mode. Other user codes can be programmed as master codes also if required. The Installer code is stored at address 249 and is used to move from *Client* Program mode up to *Installer* Program mode.

Codes 1-50 may be varied in length from 1 to 6 digits. Code 249 must be 3-6 digits.

To program a User Code you must first be in client or installer program mode, then select the address from 1-50. (If there is already a code programmed at this address, it will be flashed back to you)

NOTE: Not all User Codes may have the ability to access Client Program Mode. The installer can restrict access to Users so that they have no access to Client Mode or they can have access to change only their code or they may have access to change all User codes as defined at addresses P101-P150.

To change User code 1 from the default setting of 1,2,3 to 9,8,7,6 you would enter the following data at the keypad.

P 1 E
(Old code is flashed back at the keypad, in this case it will be 1,2,3)
Then **9876 E**
3 beeps - program light On or Flashing
The new code will now be displayed back using the keypad LED's

User 1 Code
1 2 3

To program a new user code for User 5 you would enter the following;

P 5 E
(If a code was there it would be displayed if not the display will be blank)
Then **567 E**
3 beeps - program light On or Flashing
The new code will now be displayed back using the keypad LED's

To replace a code simply enter the new code in the same address as the old code. This will overwrite the previous code but maintain the user permissions as mapped to that user number.

To clear or delete a code in LED Keypad simply press the BYPASS button at the address where the old code is stored. eg. P 3 E <BYPASS> E 3 beeps - Program light On or Flashing
When flashing back codes and values Zone indicators 1-8 are used to indicate digits 1-8. The digit 0 is indicated by the "A" LED and 9 is indicated by the "B" LED

To clear or delete a code in LCD Keypad simply press the CONTROL + 0 buttons at the address where the old code is stored. eg. P 3 E <CONTROL> + 0 E 3 beeps

USER CODE PERMISSIONS

STANDARD USER CODE PERMISSIONS - P51E-P100E

- Option 1 - Code is assigned to Area A
- Option 2 - Code is assigned to Area B
- Option 3 - Code is assigned to Area C
- Option 4 - Code can Arm Area
- Option 5 - Code can Disarm Area
- Option 6 - Code can turn on Stay Mode
- Option 7 - Code can turn off Stay Mode
- Option 8 - Code can Operate control Functions.

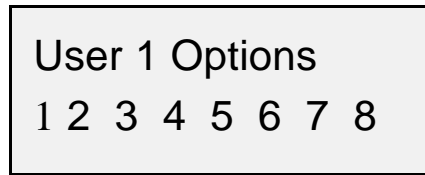

NOTE: Options 1, 2 & 3 set the Area/s the code is assigned to whereby options 4, 5, 6, 7 & 8 determine the functions the code can operate for the Area/s it has been assigned.

EXTENDED USER CODE PERMISSIONS

P101E-P150E

- Option 1 - Code can override DOTL timer
- Option 2 - Code can change dialler telephone numbers
- Option 3 - Code can alter the real time clock
- Option 4 - User can start a print-out of the event buffer
- Option 5 - User can answer an incoming call and start up/down load
- Option 6 - User can enter Client Program and change their code only
- Option 7 - User can enter Client Program and change all codes
- Option 8 - User can allow access to Installer Program mode from Client Mode

Option 1 - Code can override DOTL timer-The user can inhibit the door open too long function of the access control feature (Control) while in Client Mode. Refer to user manual for details.

Option 2 - Code can change dialler telephone numbers -The User can change telephone numbers from Client Mode.

Option 3 - Code can alter the real time clock -The User can adjust the Day ,Date & Time of the Panel Clock from Client Mode.

Option 4 - User can start a print-out of the event buffer -The User can cause a printout of the 255 event buffer to a serial printer from Client Mode.

Option 5 - User can answer an incoming call and start up/down load -The User can cause the panel to answer an in-coming call for upload/download from Client Mode.

Option 6 - User can enter Client Program and change their code only -The User can change their own code only from Client Mode.

Option 7 - User can enter Client Program and change all codes -The User can change any of the 24 User codes from Client Mode.

Option 8 - User can allow access to Installer Program mode from Client Mode – Access to Installer Mode can be granted by this user from Client Mode.

NOTE: If a user has option 7 or 8 assigned to their code then they can also initiate Walk-test Mode (P836E) from Client Program Mode.

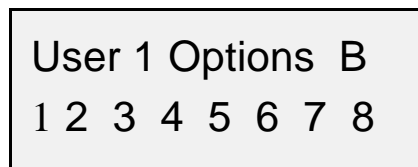

USER CODE TIME CONTROL

P151E-P200E

Users codes may have Time Zones assigned to control their operation. These Time Zones determine when a particular user code will work. Addresses P151E - P200E are used to map the user code to the required Time Zones. The actual Time Zone parameters are defined at addresses P791E - P814E.

More than one time zones can be assigned to a code. The time zones are numbered 1-8 and are selected by the numeric buttons 1-8 on the keypad. A value of zero (0) entered at any of these addresses is fixed as 24 hour seven day access and is the default time zone for all 50 user codes.

- P151E TZ E** Where TZ represents any Time Zone from 1-8 valid for User Code #1
- P152E TZ E** Where TZ represents any Time Zone from 1-8 valid for User Code #2
- P200E TZ E** Where TZ represents any Time Zone from 1-8 valid for User Code #50

NOTE: The ability to assign more than one Time Zone to each user allows for different time based controls for different days of the week.

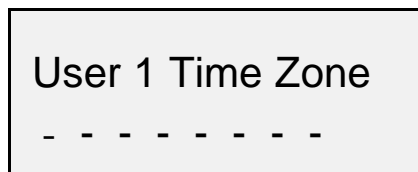

INSTALLER CODE

P249E

This code is used to enter full Installer Program mode (Program light flashing) from Client Program mode (Program light steady) The default installer code is 000000. To change this code you Must first be in Installer Program Mode then enter your new installer code at the P249E address. The new code will be flashed back to you automatically. The Installer Code may vary from 3-6 digits in length.

If the alarm is Unset then the Installer Code can gain access directly to Installer Program Mode provided Option 6 at address P310E is on. If any partition is armed then the installer code can only gain access to Installer Program Mode from Client Program Mode.

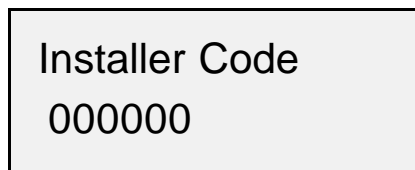

PROGRAMMING OUTPUT OPTIONS

P201E-P208E

This block of addresses (P201E - P208E) is used to map output modifiers to each of the 8 outputs available on the PW16. The optional 4 way relay output board (OUTPUTX4) can be configured to follow the program options for any of the 8 outputs, the 4 relays can be assigned as output 1 or 5, 2 or 6, 3 or 7 & 4 or 8.

- P201E 1E Invert output #1** - Default off
- 2E Flash output #1** - Default off
- 3E Single pulse to output #1** - Default off
- 4E Lockout output #1 once reset** - Default off
- 5E Output mapped to Remote Command Control** - Default off
- 6E Output mapped to local Command Control** - Default off
- 7E Day zones linked to pulse timer** - Default off
- 8E Output pulses on a 24 hour zone alarm** - Default off

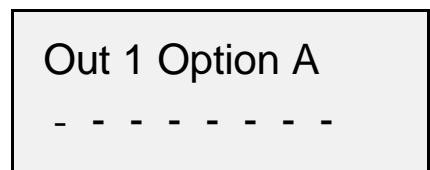

- Option 1 Invert Output** - This option is used to invert the normal state of the output. The PW16 uses open collector type transistor switches and the default state of all outputs is off or high. When in alarm the transistor switch is turned on and the output is switched low. The invert option reverses this function.
- Option 2 Flash Output** - This option causes the output to switch on and off at a rate set by the pulse timer for the output when in alarm and is normally used to flash a lamp during an activation.
- Option 3 Single Pulse to Output** - This option, when applied, produces a single pulse set by the pulse timer at the output during an alarm.
- Option 4 Lockout Once Reset** - This option is used to limit the output to one operation per arming period.
- Option 5 Output mapped to Remote Command Control** - This option is used to map an output to the remote command control function whereby the output can be controlled via the telephone (this requires the optional voice board or DTMF unit)
- Option 6 Output mapped to Local Command Control** - This option is used to map an output to the local command control feature whereby the output can be controlled directly from the keypad. The DTMF command control code at address P371 is used for this local control function.
- Option 7 Day Zones Linked to Pulse Timer** - Day Zones programmed to this output will pulse at the rate programmed for the pulse timer to this output for the duration of the day zone to Output timer (e.g. if the day zone is in partition A, then the timer at P571E applies)
- Option 8 Pulsed 24 hour alarm** - If a 24 hour zone activates the alarm this option will cause the output to pulse at a rate equal to the value set for the pulse timer for this output. This feature is provided to differentiate between a burglar and fire alarm using the same siren.

P202E - P208E As per P201E above for Outputs 2-8

PRIMARY ALARMS TO OUTPUT OPTIONS

P211E - P218E

In this block of addresses P211E relates to output #1, P212E relates to output #2 etc

- P211E 1E Keypad Panic Alarm to Output #1**
- 2E Keypad Fire Alarm to Output #1**
- 3E Keypad Medical Alarm to Output #1**
- 4E Duress Alarm to Output #1**
- 5E Wrong Code Tamper Alarm to Output #1**
- 6E Radio Key Panic Alarm to Output #1**
- 7E 24 Hour Zone Alarm to Output #1**
- 8E 24 Hour Fire Zone Alarm to Output #1**

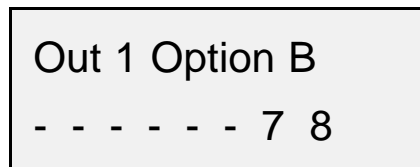

- Option 1 Keypad Panic to Output** - This option is used to map the operation of the keypad panic button to an output i.e. when the Panic button (or 1 & 3) on a keypad is pressed any output with this option enabled will turn on.
- Option 2 Keypad Fire Alarm to Output** - This option is used to map the operation of the keypad Fire Alarm (buttons 4 & 6) to an output i.e. when the Fire Alarm (4 & 6) on a keypad is pressed any output with this option enabled will turn on.
- Option 3 Keypad Medical Alarm to Output** - This option is used to map the operation of the keypad Medical Alarm (buttons 7 & 9) to an output i.e. when the Medical Alarm (7 & 9) on a keypad is pressed any output with this option enabled will turn on.
- Option 4 Duress Alarm to Output** - This option is used to map a Duress Alarm to an output. A Duress Alarm is generated when the alarm is unset by a valid user that adds the duress digit to the beginning of their code
- Option 5 Wrong Code Tamper Alarm to Output** - This option is used to map the Wrong Code Tamper Alarm to an output. A Wrong Code Tamper Alarm is generated if an invalid code is entered more than 4 times at a keypad. This option will cause the output to turn on when this alarm condition is present.

- Option 6 Radio Key Panic Alarm to Output** - This option is used to map the operation of the Radio Key Panic Alarm to an output i.e. when the Radio Panic is generated any output with this option enabled will turn on.
- Option 7 24 Hour Zone Alarm to Output** - This option is used to map 24 Hour Zone Alarms to an output i.e. when the 24 Hour Zone Alarm is generated any output with this option enabled will turn on.
- Option 8 24 Hour Fire Zone Alarm to Output** - This option is used to map 24 Hour Fire Alarm to an output. When the 24 Hour Fire Alarm is generated this will cause the output to flash at a rate set by the pulse timer for this output to identify the difference between a fire alarm and normal burglar alarm.

SECONDARY ALARMS TO OUTPUT OPTIONS

P221E - P228E

In this block of addresses P221E relates to output #1, P222E relates to output #2 etc

- P221E 1E Zone Tamper Alarm to Output #1**
- 2E System Tamper Alarm to Output #1**
- 3E Mains Failure to Output #1**
- 4E Panel Battery Low to Output #1**
- 5E Telephone Line Failure to Output #1**
- 6E Dialler Failure to get a Kiss-off to Output #1**
- 7E Automatic Pulse to Output #1**
- 8E 24 Hour Smoke Reset to Output #1**

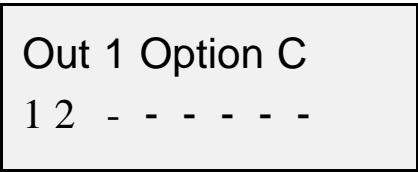

- Option 1 Zone Tampers to Output** - Where dual end-of-line resistors are being used to provide individual zone tampers this address is used to map the Zone Tampers to an output.
- Option 2 System Tamper Alarm to Output** - This option is used to map activations of the common Tamper Input to an output. This common tamper input is normally used to monitor the panel cabinet and satellite tamper switches.
- Option 3 Mails Failure To Output** - A mains failure will be indicated at the output when this option is enabled. The Alarm Reset Timer for this output must be set to "0".
- Option 4 Panel Battery Low to Output** - A battery Low condition will be indicated at the output when this option is enabled. The Alarm Reset Timer for this output must be set to "0"..
- Option 5 Telephone Line Failure to Output** - A telephone line failure will be indicated at this output when option is enabled. When the line restores this output will return to normal.
- Option 6 Dialler Failure to get a Kiss-off to Output** - If the dialler reaches its maximum dialling attempts for an alarm condition and is not kissed off, this failure will be indicated at the output. When this alarm event is accessed via Memory Mode at any keypad the output will reset back to normal.
- Option 7 Automatic Pulse to Output** - This option will cause the output to pulse (at a rate set by the pulse timer for the output) every 5 seconds. It is primarily designed to flash an external light to show that the alarm is still active (reassurance indication).
- Option 8 24 Hour Smoke Reset to Output** - This option will cause the output to pulse for 2 seconds on arming of any Area following a 24 Hour zone alarm. It is designed to allow automatic reset of smoke detectors following an alarm.

OUTPUT AUTO ON/OFF TIME ZONES

P231E - 238E

These addresses are used to map automatic ON and OFF periods to each of the outputs if required. When a time-zone starts it will cause the output to turn on and when the time-zone ends it will cause the output to turn off. The actual times assigned to each time-zone are defined at addresses P791E - P814E. Multiple Time Zones may be assigned to each output

NOTE: A value of zero (0) at these addresses will disable any auto turn on turn off features at that output.

P231E TZE Where TZ represents a Time-Zone # from 1-8 which defines the turn on and turn off times required for output #1

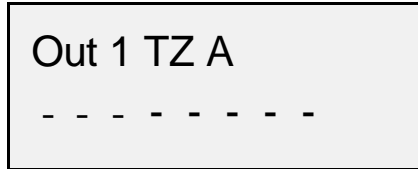

P232E - P238E As per above but for outputs 2-8

OUTPUT INHIBIT TIME ZONES

P241E - P248E

These addresses are used to map inhibit time-zones to each of the outputs as required. The assigned time-zone will enable the output so that it can be used during the time-zone. If an output has a time-zone assigned and that time-zone is off, the output cannot be turned on by any programmed function (the output is inhibited). The actual times assigned to each time-zone are defined at addresses P791E - P814E. This feature is normally used to restrict the Access Control functions to pre-determined times and days

P241E TZE Where TZ represents the time zone which enables output #1

P242E TZE Where TZ represents the time zone which enables output #2

P243E TZE Where TZ represents the time zone which enables output #3

P244E - P248E As per above but for outputs 4-8

NOTE: A value of zero (0) at these addresses will enable that output at all times.

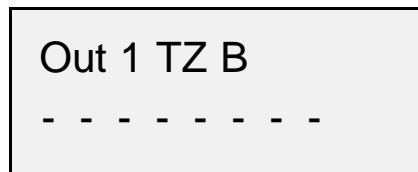

PROGRAMMING KEYPAD OPTIONS

P250E - P278E

The block of addresses from P250E to P278E are used to assign the basic options of each keypad in the system. Each of the address lines from P250E to P278E may have 8 options assigned where the 8 options represent the individual addresses of the keypads in the system. i.e. if options 1, 2 & 4 are enabled at address P250E then keypads 1, 2 and 4 would be assigned to area "A".

NOTE: A keypad can only be used to control the partition or area to which it has been assigned.

Within the display of the PW16 keypads you will find the indicators "A", "B" and "C". These indicators are used to show the Armed state of individual areas (LED on) of whether an area is in Stay Mode (LED flashing).

P250E 1-8E **Keypads assigned to Area A** (Default 1-8)
If the LED is On, the keypad is assigned to Area A.

P251E 1-8E **Keypads assigned to Area B** (Default none)
If the LED is On, the keypad is assigned to Area B.

P252E 1-8E **Keypads assigned to Area C** (Default none)
If the LED is On, the keypad is assigned to Area C.

P253E 1-8E **Keypads with permission to fully Arm** (Default 1-8)
If the LED is On, the keypad is allowed to Arm the assigned Area/s.

P254E 1-8E **Keypads with permission to arm Stay Mode** (Default 1-8)
If the LED is On, the keypad is allowed to Arm Stay Mode for the assigned Area/s.

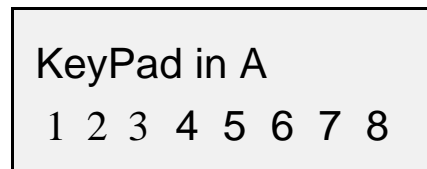

- P255E 1-8E Keypads with permission to use the Control Function** (Default 1-8)
If the LED is On, the keypad can operate the “Control” function for the assigned Area/s.
- P256E 1-8E Keypads with permission to Bypass** (Default 1-8)
If the LED is On, the “Bypass” button on the keypad is enabled.
- P257E 1-8E Keypads with Panic button enabled** (Default 1-8)
If the LED is On, the “Panic” button on LED keypads is enabled.
- P258E 1-8E Keypads with delayed Panic button enabled** (Default 1-8)
If the LED is On, the “Panic” button on LED keypads must be held down for 2 seconds to create a panic alarm. The option at address P257E MUST be off for the delayed option to work.
- P259E 1-8E Keypads with Buttons 1 & 3 Panic Alarm enabled** (Default 1-8)
If the LED is On, pressing buttons 1&3 simultaneously will create a Panic alarm at the keypad.
- P260E 1-8E Keypads with Buttons 4 & 6 Fire Alarm enabled** (Default 1-8)
If the LED is On, pressing buttons 4&6 simultaneously will create a Fire alarm at the keypad
- P261E 1-8E Keypads with Buttons 7 & 9 Medical Alarm enabled** (Default 1-8)
If the LED is On, pressing buttons 7&9 simultaneously will create a Medical alarm at the keypad

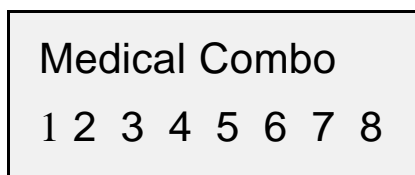

- P262E 1-8E Keypads with buzzer mapped to normal zone alarms** (Default 1-8)
If the LED is On, a Zone alarm during the Armed state will cause the Keypad buzzer to sound (audible alarm) at the keypad.
- P263E 1-8E Keypads with buzzer mapped to stay mode zone alarms** (Default 1-8)
If the LED is On, a Stay Mode Zone alarm during the Armed state will cause the Keypad buzzer to sound (audible alarm) at the keypad.
- P264E 1-8E Keypads with buzzer mapped to 24 hour zone alarms** (Default 1-8)
If the LED is On, a 24 Hour Zone alarm will cause the Keypad buzzer to sound (audible alarm) at the keypad.
- P265E 1-8E Keypads with buzzer mapped to day mode alarms** (Default 1-8)
If the LED is On, a Day Zone alarm will cause the Keypad buzzer to sound (audible alarm) at the keypad.
- P266E 1-8E Keypads with buzzer mapped to armed mode exit delay beeps** (Default 1-8)
If the LED is On, the keypad will sound the exit beeps when the system is armed to indicate the exit delay has started.
- P267E 1-8E Keypads with buzzer mapped to stay mode exit delay beeps** (Default 1-8)
If the LED is On, the keypad will sound the exit beeps when stay mode is armed to indicate the exit delay has started.
- P268E 1-8E Keypads with buzzer mapped to entry delay beeps** (Default 1-8)
If the LED is On, the keypad will sound the entry beeps to indicate the entry delay has started.
- P269E 1-8E Keypad buzzer to warn of zone inactivity or supervised radio timeout alarm** (Default 1-8)
If the LED is On, a Supervised Radio signal failure or no activity on a zone for the programmed period will cause the buzzer at the keypad buzzer to sound. Pressing any button will silence the beep.
- P270E 1-8E Keypads with buzzer mapped to keypad tampers** (Default 1-8)
If the LED is On, a keypad tamper alarm (four incorrect attempts to enter in a code) or a Crow keypad tamper switch alarm will cause the buzzer at the keypad to sound.
- P271E 1-8E Keypads with buzzer mapped to zone tampers** (Default 1-8)
If the LED is On, a zone tamper alarm will cause the buzzer at the keypad to sound.
- P272E 1-8E Keypads with buzzer mapped to system tampers** (Default 1-8)
If the LED is On, a system tamper alarm will cause the buzzer at the keypad by to sound.



- P273E 1-8E Keypads with buzzer mapped to Pendant "Panic" Alarm** (Default 1-8)
If the LED is On, a radio Pendant Panic alarm will cause the buzzer at the keypad to sound.
- P274E 1-8E Keypads with buzzer mapped to keypad "Panic" or "(1 & 3)" Alarm** (Default 1-8)
If the LED is On, a Keypad Panic alarm will cause the buzzer at the keypad to sound.
- P275E 1-8E Keypads with buzzer mapped to keypad "Fire" (4 & 6) Alarm** (Default 1-8)
If the LED is On, a Keypad Fire alarm will cause the buzzer at the keypad to sound.
- P276E 1-8E Keypads with buzzer mapped to keypad "Medical" (7 & 9) Alarm** (Default 1-8)
If the LED is On, a Keypad Medical alarm will cause the buzzer at the keypad to sound.
- P277E 1-8E Keypads with buzzer mapped to phone line failure** (Default none)
If the LED is On, a Telephone Line Failure will cause the buzzer at the keypad to sound. Pressing any button will silence the beep.
- P278E 1-8E Keypads with facility to turn the LED's off after Exit Delay** (Default none)
If the LED is On, the Zone & System LED's on an LED keypad will turn off when all areas assigned to the keypad are Armed or in Stay mode. On an LCD keypad, the LCD and the keypad button backlighting will turn off when Armed or in Stay Mode. The LED's and backlighting will automatically turn on again if there is an alarm, an entry delay is started, any button is pressed at the keypad or when the system is Disarmed.

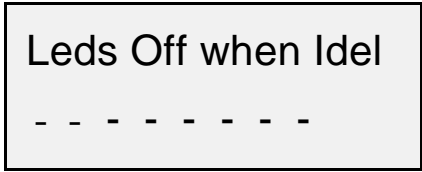

PARTITION "A,B & C" PRIMERY OUTPUT OPTIONS

- PARTITION "A" - P281E - P288E
- PARTITION "B" - P381E - P388E
- PARTITION "C" - P481E - P488E

The addresses above allow a number Area based options to be assigned to any of the 8 outputs. Address P281 relates to Output 1 options for Area A, address P381 relates to Output 1 options for Area B and address P481 relates to Output 1 options for Area C.

- P281E 1E Normal zone alarms to output #1**
- 2E Stay Mode alarms to output #1**
- 3E Pendant chirps to output #1**
- 4E All zones sealed indication to output #1**
- 5E 2 second pulse on arming or disarming to output #1**
- 6E Spare**
- 7E Day zone alarms to output #1**
- 8E Spare**

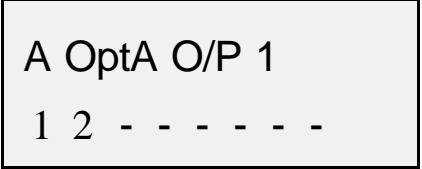

- Option 1 Normal zone alarms to output #1** - This option will map activation from normal zone alarms from Area "A" to output #1. Normal zones are those which will only activate when the partition is armed (Set)
- Option 2 Stay Mode alarms to output #1** - This option will map activations from zones defined as Area "A" Stay Mode to output #1. Zones are defined as being in Stay Mode at P445E and P465E
- Option 3 Pendant Chirps to output #1** - This option will map two short pulses (Chirps) to output #1 when Area "A" is set via a radio key (Pendant) and four short pulses to output #1 when Area "A" is unset again. The length of the pulses (Chirps) are set by the pulse timer for this output.
- Option 4 All zones sealed indication to output #1** - This option will map an Area "A" "Ready" indication to output #1. A "Ready" indication is produced when all zones in an area are sealed, i.e. zone lights off.
- Option 5 2 second pulse to output #1 on arming or disarming** - This option will map a 2 second pulse to Output #1 each time Area "A" is armed or disarmed as defined at P302E options 6&7.
- Option 6 Spare**
- Option 7 Day zone alarms (Chime) to output #1** - The option will map activations from Area "A" zones defined

as Day Zones to output #1. Zones are defined as Day Zones at P453E/P454E and P473E/P474E. Day zones are those which operate only during periods when the Area is disarmed and are normally used as door bells and shop minders etc.

Option 8 Spare

- Note: P282E through P288E are as above but apply to outputs 2-8 for Area A**
- Note: P382E through P388E are as above but apply to outputs 2-8 for Area B**
- Note: P482E through P488E are as above but apply to outputs 2-8 for Area C**

PARTITION "A,B & C" SPECIFIC OUTPUT OPTIONS

- PARTITION "A" - **P291E - P298E**
- PARTITION "B" - **P391E - P398E**
- PARTITION "C" - **P491E - P498E**

The addresses above allow a number of secondary Area based options to be assigned to any of the 8 outputs. Address P291 relates to Output 1 options for Area A, address P391 relates to Output 1 options for Area B and address P491 relates to Output 1 options for Area C.

- P291E**
- 1E Any exclude to output #1**
 - 2E Auto-Exclude warning to output #1**
 - 3E Entry beeps to output #1**
 - 4E Exit beeps to output #1**
 - 5E Control function to output #1**
 - 6E Arm indication to output #1**
 - 7E Stay Mode Arm indication to output #1**
 - 8E Disarm indication to output #1**

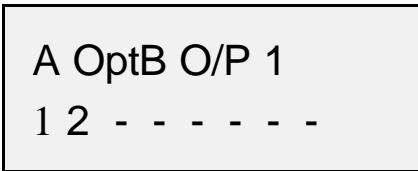

- Option 1 Any exclude to output #1** - This option will produce a change of state at output #1 if there are any zones excluded, either manually or automatically. This change of state will occur at the end of the Exit delay. The output reset time (P551E) should be set to zero when this option is enabled.
- Option 2 Auto-Exclude warning to output #1** - This option will produce a 2 second pulse at output #1 at the end of the exit period if a zone has been Auto-excluded in Area "A". An Auto-Exclude occurs when a zone is left un-sealed at the end of the exit delay. At the end of the exit delay zones not defined as Auto-Exclude which are left un-sealed will produce an activation. Auto-Exclude assignments are found at P447E and P467E
- Option 3 Entry beeps to output #1** - This option will map the keypad entry beeps to output #1.
- Option 4 Exit beeps to output #1** - This option will map the keypad exit beeps to output #1.
- Option 5 Control function to output #1** - This option maps the control functions in Area "A" to output #1. Control function parameters for Area "A" are defined at P301E options 5-8
- Option 6 Arm indication to output #1** - This option will turn output #1 on when Area "A" is armed and turn output #1 off when Area "A" is disarmed. This change of state occurs at the start of the exit delay and when the Area is disarmed. Output reset time should be set to zero (P551E 0E)
- Option 7 Stay Mode Arm indication to output 1** - This option will turn output #1 on when Area "A" is placed in Monitor Mode and turn output #1 off when Area "A" Monitor Mode is turned off. Like option 6 this change of state occurs either at the start of the exit delay or when the Area is disarmed. Output reset time should be set to zero (P551E 0E)
- Option 8 Disarm indication to output #1** - This option will turn output #1 on when Area "A" is disarmed either from Full Arm or Stay Mode and turn output #1 off when Area "A" is Armed or in Stay Mode. Like option 6 this change of state occurs either at the start of the exit delay or when the Area is disarmed. Output reset time should be set to zero (P551E 0E)

- Note: P292E through P298E are as above but apply to outputs 2-8 for Area A**
- Note: P392E through P398E are as above but apply to outputs 2-8 for Area B**
- Note: P492E through P498E are as above but apply to outputs 2-8 for Area C**

PARTITION KEYPAD OPTIONS

PARTITION A - P299E & P300E
 PARTITION B - P399E & P400E
 PARTITION C - P499E & P500E

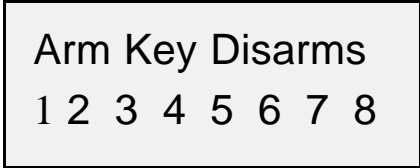

P299E "ARM" key can disarm during exit delay - This option enables the one key disarm during exit delay feature on a keypad by keypad basis with Partition boundaries . Options 1-8 represent keypads 1-8

P300E "STAY" key can disarm during Monitor Mode - This options enables single button disarm of Stay mode via the "STAY" key. Options 1-8 represent keypads 1-8

Note: P399E & P400E are as above but apply to keypads in Area B

Note: P499E & P500E are as above but apply to keypads in Area C

PROGRAMMING PARTITION PARAMETERS

PARTITION "A" TIME ZONE AUTO ARM/DISARM OPTIONS - P290E

PARTITION "B" TIME ZONE AUTO ARM/DISARM OPTIONS - P390E

PARTITION "C" TIME ZONE AUTO ARM/DISARM OPTIONS - P490E



P290E 1-8 Time Zone to use for Auto Arm or Disarm (Default 0) - This option will determine which Time Zone/s will cause Area "A" to arm, disarm or both, based on the programmed options set at P203E for Area A.

Note: P390E is the same as above but applies to Area B Time Zone Arm/Disarm

Note: P490E is the same as above but applies to Area C Time Zone Arm/Disarm

PARTITIONS TIME AND DELAY OPTIONS

PARTITION "A" - P303E

PARTITION "B" - P403E

PARTITION "C" - P503E

- P303E 1E** Set partition when time zone ends -Default off
- 2E** Unset partition when time zone starts - Default off
- 3E** Disable stay mode exit delay - Default off
- 4E** Disable set mode exit delay - Default off
- 5E** Disable stay mode entry delay - Default off
- 6E** Disable set mode entry delay - Default off
- 7E** Use special stay mode entry delay - Default off
- 8E** Send alarms and bypasses in stay mode - Default off

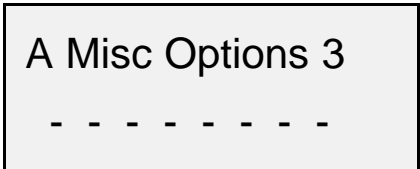

Option 1 Set partition when time zone ends - this option will automatically arm partition "A" when the time zone programmed at address P290E finishes.

Option 2 Unset partition when the time zone starts - this option will automatically disarm partition "A" when the time zone programmed at address P290E starts.

Option 3 Disable stay mode exit delay - If this option is on the exit delay for partition "A" becomes "0"

when arming stay mode (the delay will still apply to full arm unless option 4 is also on).

- Option 4** **Disable set mode exit delay** - If this option is on the exit delay for partition "A" becomes "0" when arming the panel (the delay will still apply to stay mode unless option 3 is also on).
- Option 5** **Disable stay mode entry delay** - If this option is on then all zones are instant in stay mode regardless of any entry delays programmed to zones (entry delays will still apply to zones in full arm mode unless option 6 is also on).
- Option 6** **Disable set mode entry delay** - If this option is on then all zones are instant in full set mode regardless of any entry delays programmed to zones (entry delays will still apply to zones in stay mode unless option 5 is also on).
- Option 7** **Use special stay mode entry delay** - If this option is on then all zones use the special Stay Mode entry delay (P540E) in stay mode and the normal delays programmed at addresses P511E—P526E are ignored.
- Option 8** **Send alarms and bypasses in stay mode** - If this option is on then all alarms and zone bypasses in Stay mode will be reported via the dialler in Contact D. Only zone alarms will be reported if using Domestic/ Voice or Pager reporting formats. You should also note that if a Stay mode alarm is not kissed of in Domestic/ Voice or Pager mode and the alarm is not disarmed, when the dialler test time comes around, the zone alarms will report again. If this is not desired you can stop this from happening by turning of all days for the test time at address P815E.

Note: P403E is the same as above but applies to Area B Time & Delay options
Note: P503E is the same as above but applies to Area C Time & Delay options

PARTITIONS MISC KEYPAD OPTIONS

PARTITION "A" - P301E
PARTITION "B" - P401E
PARTITION "C" - P501E

- P301E** **1E Cannot Arm if not Ready**
- 2E Arm key required before code to set**
- 3E Stay key required before code to arm Stay Mode**
- 4E Code required to arm area**
- 5E Control function requires code**
- 6E Control function toggles**
- 7E Control function is momentary**
- 8E Control Button disables "Day/Chime" mode or directly Controls Outputs**

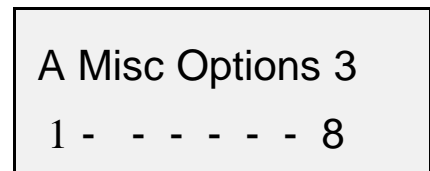

- Option 1** **Cannot Arm if not Ready** - This option if turned on will inhibit arming of Area "A" if any zone in area A is unsealed (Not Ready). If the option is off, the area can be armed with zones unsealed but the panel will either auto-exclude the zone or go into alarm at the end of the exit delay depending upon other option settings. If required, certain zones can be exempted from this feature if they are in low security areas, allowing the area to be armed with a zone/s unsealed, by selecting the zones at addresses P460E AND P480E. This option does not apply to Stay mode.
- Option 2** **Arm key required before code to set** - This option determines if the "ARM" key must be pressed before a code is entered to set Area "A". This option must be enabled where a keypad is assigned to more than one area.
- Option 3** **Stay key required before code to arm Stay Mode** - This option determines if the "STAY" key is a single button function or must be pressed followed by a code to turn on Stay Mode in Area "A". This option must be enabled where a keypad is assigned to more than one area. If off, Stay mode is turned on by pressing the Stay button only, if on, you must enter a code after pressing the stay button. When Arming Stay Mode, if the user presses the "Enter" button during the exit delay, this will cancel any remaining exit delay time and make all Stay zones instant, even if they have an entry delay time programmed.
- Option 4** **Code required to arm area** - If this option is off the partition can be shortcut armed. Shortcut arming

is when the area can be set by pressing the "ARM" key only, i.e. no code is required. If this option is on, a valid Area "A" user code is required to set the area.

- Option 5 Control function requires code** - This option determines if a code is required to operate the Control function. The Control function provides the ability to operate an output from a key press rather than from an alarm event. If this option is off, pressing the "CONTROL" key will produce an output as assigned at P291E through P298E option 5. If the option is on, you must press "CONTROL" followed by a valid code assigned with the control feature to operate the control output.
- Option 6 Control function toggles** - If this function is enabled, the output which is mapped to the control function will toggle to the opposite state each time the control function is operated, i.e. if the output is on it will turn off etc. If the reset time mapped to the control output is zero the output will remain on until the control function operates again and toggles it off. If there is a reset time mapped to the control output, the output will turn off at the end of the reset time as expected. The next time the Control function is operated the output will come on again for the reset period then turn off.
- Option 7 Control function is momentary** - If this option is enabled, the output which is mapped to the control function will turn on for the time period as determined by the value of the pulse timer mapped to the control output.
- Option 8 Control Button disables "Day/Chime" mode or directly Controls Outputs** - If this option is enabled (LED 8 On), pressing the CONTROL button will put the LED keypads in the special "Control" mode, indicated by the Control LED turning on. At this point two operations may be performed. The first is that Outputs can be turned On or Off by selecting the Output number/s required (after first pressing Control) then pressing the enter button to exit Control mode (for outputs to be controlled at this point option 6 at P201-P208 must be on). The second option is to press the "Program" button after pressing the "Control" button which will disable the day alarms for the partition assigned to the keypad. When the day alarms disable mode is active the CONTROL light will be on. To restore the day function simply press Control then Program buttons again. A similar set of options are available on the LCD keypad but to disable day alarms you can either press and hold the "Chime" button or hold down the Control button and with 2 seconds also press the Program button to achieve the same result. On the LCD keypad it shows "Chime Off" when the day alarms are disabled.
If the option is disabled (LED 8 Off) the control button is used to operate the Control Output as assigned at addresses P291-298, 391-398, 491-498 option 5.

We advise that only one of the Control Function options be assigned at the above address.

Note: P401E is the same as above but applies to Area B Keypad options

Note: P501E is the same as above but applies to Area C Keypad options

PARTITIONS MISC OPTIONS

PARTITION "A" - P302E

PARTITION "B" - P402E

PARTITION "C" - P502E

- P302E 1E Key-switch Input enabled**
- 2E Use 2nd Key-switch**
- 3E Key-switch is used for Arm or Stay**
- 4E Pendant chirps on Arming / disarming**
- 5E Pendant chirps on Stay Mode on / off**
- 6E 2 second output on Arming**
- 7E 2 second output on Disarming**
- 8E Access Control enabled even when Area is armed**

A Misc Options 2

- - 3 4 - 6 - -

- Option 1 Key-switch Input enabled** - This option will enable the Key-switch input. Operating the Key-switch input will arm Area "A" as determined by P302E option 3. The Key-switch type is programmed at P311E options 2, 3 & 4.
- Option 2 Use 2nd Key-switch** - This option will enable dual end of line configuration of the Key-switch input and assign the high value end-of-line (8k2) to Area "A" (refer to the zone drawing on [page 6](#) Type 3 or 4). Also option 2 at address P311E selects whether a tamper is available when the 2nd key-switch is used.

- Option 3 **Key-switch is used for arm or Stay** - If this option is on, operating the Key-switch will arm Area "A". If this option is off, operating the Key-switch will turn Area "A" Stay Mode on and off.
- Option 4 **Pendant Chirps on arming / disarming** - This option will send two short pulses (Chirps) to the output mapped at P281E - P288E option 3 when Area "A" is set via a radio key (Pendant) and four short pulses to the output when Area "A" is unset again.
- Option 5 **Pendant Chirps on Stay Mode on / off** - This option will send two short pulses (Chirps) to the output mapped at P281E - P288E option 3 when Stay Mode for Area "A" is turned on with a radio key (Pendant) and four short pulses to the output when Area "A" Stay Mode is turned off.
- Option 6 **2 second output on Arming** - If this option is on, the output which is assigned by P281E - P288E option 5 will turn on for 2 seconds when Area "A" is armed.
- Option 7 **2 second output on Disarming** - If this option is on, the output which is assigned by P281E - P288E option 5 will turn on for 2 seconds when Area "A" is disarmed.
- Option 8 **Access Control enabled even when area is armed** - If this option is enabled, the Access Control functions, as determined by P456E, P457E, P476E and P477E will work at all times, even when Area "A" is in the set condition.

Note: P302E is the same as above but applies to Area B Miscellaneous options
Note: P402E is the same as above but applies to Area C Miscellaneous options

AREA SPECIFIC REPORTING OPTIONS

P289E 1-8E Area A Reporting Options - Default 1,2

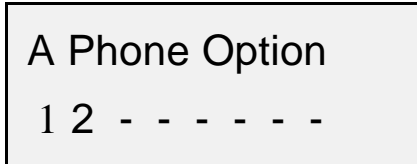

- 1 = Send Arm/Disarm
- 2 = Send Stay Mode Arm/Disarm
- 3 = Send Disarm only after activations
- 4 = Send Stay Disarm only after activations
- 5 = Send Arm at the end of the exit delay
- 6 = Send all zone restores when disarmed
- 7 = Spare
- 8 = Spare

- Option 1 **Send Arm / Disarm** - If this option is on, the dialler will report Area "A" arms and disarms.
- Option 2 **Send Stay Mode Arm / Disarm** - If this option is on, the dialler will report Area "A" stay mode arms and disarms.
- Option 3 **Send Disarm only after activation** - If this option is on, the dialler will report an Area A disarm following an alarm activation only. This option is often used in conjunction with alarm only reporting and stops the normal arm/disarm signals from being sent. If this option is on it will override the option 1 setting.
- Option 4 **Send Stay Mode Disarm only after activation** - If this option is on, the dialler will report an Area A Stay Mode disarm following an alarm activation only. This option is often used in conjunction with alarm only reporting and stops the normal Stay Mode arm/disarm signals from being sent. If this option is on it will override the option 2 setting.
- Option 5 **Send Arm at the end of the exit delay** - If the LED is Off, the dialler will report an Arm immediately the panel is armed. If the LED is On, the Arm report is sent at the expiry of the exit delay.
- Option 6 **Send all zone restores when disarmed** - If this option is off, the dialler will send all zone restores as they occur. If the option is on, the dialler will send all zone restores only when the panel is disarmed.
- Option 7 **Spare**

Option 8 Spare

P389E 1-8E Area "B" Reporting Options - (see above for details) Default 1,2
P489E 1-8E Area "C" Reporting Options - (see above for details) Default 1,2

PROGRAMMING MISCELLANEOUS PANEL OPTIONS

P310E

P310E 1E Ignore Mains input
2E Siren tone to Output # 1
3E Siren tone to Output # 2
4E Alert Keypad LEDS off when Armed
5E Ignore Zone tampers during exit delay
6E Installer has direct access to program mode
7E Installer lockout
8E Area "C" zones are shared with Area "A" & "B", i.e. Area "C" zones are common to "A" & "B"

Misc Option A
- - - - - 6 - 8

Option 1 Ignore Mains Input - If the panel must be run off a 12v DC supply only such as a solar application the 12v can be applied to the battery input and the mains input is ignored.

Option 2 Siren tone to Output # 1 - The alarm panel has an on-board siren driver for driving horn speakers directly. If this option is On, the panel will drive an 8 ohm horn speaker directly from output 1. If the option is Off, the output will switch hard to 0v. NOTE: always ensure that this option is turned on first before connecting a horn speaker to the output otherwise damage will occur. Also, if the listen-in to output 1 feature is used (P313E) then this option must be turned on and a horn speaker connected to output 1 for the listen-in feature to work.

Option 3 Siren tone to Output # 2 - The alarm panel has an on-board siren driver for driving horn speakers directly. If this option is On, the panel will drive an 8 ohm horn speaker directly from output 2. If the option is Off, the output will switch hard to 0v. NOTE: always ensure that this option is turned on first before connecting a horn speaker to the output otherwise damage will occur.

Option 4 Alert Keypad LEDS off when Armed - If this option is on and an Alert Keypad is connected to the panel, the system LED's will turn off on the keypad when the alarm is armed. The LED's will come back on automatically when an alarm occurs, an entry delay is active, a button is pressed at the keypad or the system is disarmed.

Option 5 Ignore Zone tampers during exit delay - If this option is on, any zone tampers created during the exit delay will be ignored. When the delay expires the zone tampers will be active again.

Option 6 Installer has direct access to program mode - If this option is on, the installer code will allow access directly to Installer Program Mode provided no areas are armed or in stay mode.

Option 7 Installer lockout - If this option is on, the installer "Back Door" power up access to program mode will be disabled. When this option is on the installer code is the only method of accessing installer program mode.

Option 8 Area "C" zones are shared with Areas "A" & "B" - If the system uses zones which are common to Area "A" and Area "B" then Area "C" is used for those shared zones. If zones are not shared between A & B then Area "C" is available as a independent partition. LED's on = Shared.

MISCELLANEOUS SYSTEM OPTIONS "B"

KEY-SWITCH and TAMPER OPTIONS - P311E

P311E 1E Cabinet tamper is loop or end-of-line
2E Key-switch input is loop or end-of-line
3E Low Key-switch is momentary or latching
4E High Key-switch is momentary or latching
5E Spare
6E Spare

Misc Option A
1 2 3 4 - - - -

7E Spare
8E Spare

- Option 1** **Cabinet tamper is loop or end-of-line** - This option determines if the Cabinet tamper input uses a closed loop or 2k2 end-of-line resistor. If this option is on the tamper is a 2k2.
- Option 2** **Cabinet tamper is loop or end-of-line** - This option determines if the Cabinet tamper input uses a closed loop or 2k2 end-of-line resistor. If this option is on the tamper is a 2k2.
- Option 3** **Low Key-switch is momentary or latching** - This option determines if the low Key-switch (4k7) is momentary or latching. If option 3 is on the low Key-switch will be momentary
- Option 4** **High Key-switch is momentary or latching** - This option determines if the high Key-switch (8k2) is momentary or latching. If option 4 is on the high Key-switch will be momentary

PROGRAMMING DURESS DIGIT

P350E

- P350E 0-9** **Duress Digit** (Default 0) - A Duress Alarm is activated only when the "Duress Digit" defined at this address is prefixed to a valid user code. The resulting Duress Alarm will unset the Area in the normal way, operate an output if one is defined and report a duress event via the communicator. Values of 0-9 may be entered at this address where 0 = option disabled and 1-9 represent valid digits 1-9.

Duress Digit 0

SETTING ZONE RESPONSE TIME

- P420E** **Zone Response Time Setting - 1-31E.** Default = 6

The input response count sets the total time the zones must be in alarm before the state is recognised by the panel. A count of 1 = 45ms. The default setting of 6 therefore results in a zone response time of 270ms.

Zone Response se 6

SETTING ZONE VIBRATION SENSITIVITY

P411E - P418E

Only the first 8 zones may be defined as vibration sensor zones with a vibration sensitivity level as required. If a value other than zero is assigned at addresses P411E to P418E the zone which has been assigned that value automatically becomes a vibration zone. To turn a vibration zone back into a normal zone assign a zero value at the relevant address. Zero is the default setting.

- P411E 0-8E** **Zone 1 vibration sensitivity** - Where 0 = none, 1 is highest and 8 is lowest sensitivity level.
- P412E 0-8E** **Zone 2 vibration sensitivity** - Where 0 = none, 1 is highest and 8 is lowest sensitivity level.
- P413E 0-8E** **Zone 3 vibration sensitivity** - Where 0 = none, 1 is highest and 8 is lowest sensitivity level.
- P414E 0-8E** **Zone 4 vibration sensitivity** - Where 0 = none, 1 is highest and 8 is lowest sensitivity level.
- P415E 0-8E** **Zone 5 vibration sensitivity** - Where 0 = none, 1 is highest and 8 is lowest sensitivity level.
- P416E 0-8E** **Zone 6 vibration sensitivity** - Where 0 = none, 1 is highest and 8 is lowest sensitivity level.
- P417E 0-8E** **Zone 7 vibration sensitivity** - Where 0 = none, 1 is highest and 8 is lowest sensitivity level.
- P418E 0-8E** **Zone 8 vibration sensitivity** - Where 0 = none, 1 is highest and 8 is lowest sensitivity level.

SOAK-TEST ZONES

If a zone is suspected of being faulty, it may be disabled by making it a Soak-test zone. This means that the zone will not cause an alarm or report via the dialler, but it will still be active during the Armed state. In this way any potential activations can be monitored via the event memory for a period of time to determine whether the detector connected to the zone input is faulty or not without creating nuisance alarms. Following any tests, if the zone is found to be OK, the Soak-test mode can be turned off for that zone which then returns it back to full operation.

P408E

SOAK-TEST ZONES - 1-8

P409E

SOAK-TEST ZONES - 9-16

Zone 1-8 Soak

SINGLE OR DUAL ZONE INPUT (8 or 16 zones)

P410E 1-8E

Single or dual zone input - This option is used to define the PW16 as an 8 or 16 zone panel where options 1-8 represent zone inputs 1-8. If a LED is on at this address it means that zone has been assigned "Zone Doubling" whereby the zone input is used for both a low (1-8) and a high (9-16) zone. When zone doubling is used, zone 1 input is used for zones 1 & 9, Zone 2 input is used for zones 2 & 10, zones 3 input is used for zones 3 & 11 etc. Zone doubling is assigned on a zone-by-zone basis.

Single or Dual Zn

ZONE END OF LINE OPTIONS

SHORT CIRCUIT OR END OF LINE ZONE INPUT - **P419E**

P419E 1-8E

Short Circuit or End-of-line - This option controls whether the individual zone inputs require a 2k2 end of line (EOL) resistor or not. If zone doubling is turned off (LED off) for an input at address P410E and the corresponding input at this address is also off (LED off) then the input only requires a short circuit loop (no EOL) to seal the input and an open circuit is seen by the panel as an alarm. If this option is on and zone doubling for the same input is off then the input requires a 2k2 resistor to seal the input and if the 2k2 resistor is shorted out or open circuited then an alarm is created. If this option is off and zone doubling is on then there is no tamper monitoring on the input and only a 4k7 and 8k2 resistor are required for the two zones, a short or open circuit on the input in this configuration will be seen as both the low and high zones in alarm. Finally, if this option is on and zone doubling is on for the same input the 2k2 resistor must be fitted in conjunction with the 4k7 and 8k2 resistors. In this mode, a short or open circuit on the input will be seen as a zone tamper alarm.

Zone EOL Resistor

1 2 3 4 5 6 7 8

LOW ZONE ASSIGNMENTS ZONES 1-8

P441E - P460E

Combinations of options in addresses P441E to P460E may be used to give the most suitable zone behaviour.

P441E 1-8E

Zone is in Area "A" - Where options 1-8 represent zones 1-8. This option assigns a zone to Area "A" within a partitioned system. If the system is not partitioned, all zones must be assigned

to Area "A". (Default all in Area "A") See P310E8E also.

P442E 1-8E Zone is in Area "B" - Where options 1-8 represent zones 1-8. This option assigns a zone to Area "B" within a partitioned system. (Default none in Area "B") See P310E8E also.

If a zone is defined in both Area "A" and Area "B" it is deemed to be in Area "C"

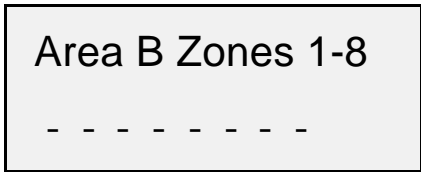

P443E 1-8E Zone is a normally open input - where options 1-8 represent zones 1-8. This option is used when normally open detectors such as smoke detectors are to be connected to a zone. The option only applies if zone doubling is turned On at P410E. Default is all zones normally closed.

P444E 1-8E Zone is a radio detector - Where options 1-8 represent zones 1-8. This option is used when Radio (wireless) devices are used as detectors. (Default none)

P445E 1-8E Stay Mode Zones - Where options 1-8 represent zones 1-8. Zones included at this address will become active when the panel is in Stay Mode. Zones not assigned at this address will be excluded. (Default 1-4) Note: Stay Mode Zones are linked to Area assignments

P446E 1-8E Zone can be Bypassed - Where options 1-8 represent zones 1-8. This option determines if a zone can be Bypassed either manually or via the Auto-Bypass process. (Default all on)

P447E 1-8E Auto Bypass Zones - Where options 1-8 represent zones 1-8. Zones assigned Auto Bypass function at this address will be automatically bypassed by the system if they are unsealed when the exit timers expire. Zones not given Auto Bypass status will cause an activation if they are unsealed at the end of the exit delay period. (Default all on)

P448E 1-8E Zone is a handover - Where options 1-8 represent zones 1-8. Zones defined at this address as handover are given the unique ability to behave as both delay and instant zones. If a zone defined as an entry delay zone has been activated and the entry delay is running, a handover zone will behave as another entry delay zone with a delay time as defined at P511E to P526E. If an entry delay zone has not been activated and there is no entry delay running, a handover zone becomes an instant zone with no entry delay. The Handover zone **MUST** have an entry delay programmed.

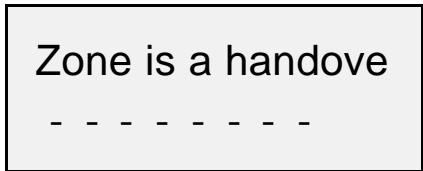

P449E 1-8E Two Trigger Zones - Where options 1-8 represent zones 1-8. A zone defined as two trigger at this address will only cause an activation if one of the following conditions are met;
a The zone is triggered twice within the two trigger time period as defined by Address P534E, P535E or P536E

b Any two zones defined as two trigger activate once each within the two trigger time period as defined by Address P534E, P535E or P536E

c A zone defined as two trigger is left violated for longer than the two trigger time period as defined by Address P534E, P535E or P536E

P450E 1-8E Zone is 24 Hour - Where options 1-8 represent zones 1-8. 24 hour zones will activate whether the panel or partition is armed or disarmed. If an entry delay is also assigned to a 24 hr zone, the alarm will not trigger unless the zone is in alarm longer than the delay time programmed. (Default none)

P451E 1-8E Zone is 24 Hour Fire Zone - Where options 1-8 represent zones 1-8. 24 hour Fire zones will activate whether the panel or partition is armed or disarmed. If an entry delay is also assigned to a 24 hr Fire zone, the alarm will not trigger unless the zone is in alarm longer than the delay time programmed. A Fire Zone will cause the output to pulse to differentiate it from a burglar alarm. (Default none)

P452E 1-8E Zone is 24 Hour Auto-Reset - Where options 1-8 represent zones 1-8. 24 hour Auto-Reset zones will activate whether the panel or partition is armed or disarmed. If an entry delay is also assigned to a 24 hr Auto-Reset zone, the alarm will not trigger unless the zone is in alarm longer than the delay time programmed. An Auto-reset zone will seal automatically when the zone input is restored back to normal i.e. does not require a code to reset an alarm. (Default none)

P453E 1-8E Day Zones - Where options 1-8 represent zones 1-8. Day zones are active during periods

where the panel or partitions are disarmed and revert to normal zones during armed periods (Default none)

- P454E 1-8E Continuous Day Zone** - Where options 1-8 represent zones 1-8. The zone acts as a day zone at all times (Armed and Disarmed) and will operate day alarms but not normal zone alarms (Default none)
- P455E 1-8E Siren Lockout Zones** - Where options 1-8 represent zones 1-8. Zones with siren lockout designation will only cause their assigned outputs to operate once per armed period. Led on = zone locked out. (Default none)
- P456E 1-8E Access Control door position input** - Where options 1-8 represent zones 1-8. The door position input becomes a 24 hour alarm zone and will alarm if the "Control" door is forced open or left open too long. It will also automatically re-lock the door after the "Control" operation has occurred and the door has been opened then closed again. (Default none)
- P457E 1-8E Access Control Request to exit input** - Where options 1-8 represent zones 1-8. The Request to Exit input will operate the "Control" door output to release the door and start the Door open Too long Timer. (Default none)
- P458E 1-8E Zone will report multiple activations to communicator** - Default 1-8. If this option is turned off then the relevant zone will only report one alarm to a monitoring company during any single armed period. If it is turned on, the zone can send multiple reports if activated more than once during a single armed period.
- P459E 1-8E Zone will be Monitored for Inactivity** - Default none. A Zone with this option turned on will be checked to ensure that it is triggered on a regular basis. If the zone is not triggered within the time period set at P469E then an alarm will be generated as the detector may have become faulty or could be masked. The timer period as set at address P569E is only active during the disarmed period. If the timer has started due to inactivity of a zone input, the elapsed time is remembered at the time of arming and will resume when the alarm is disarmed.
- P460E 1-8E Cannot Arm if Zone is Unsealed** - Default None. If a zone is unsealed (Not Ready) at the time of arming, by default the panel will Arm and the zone will either automatically be bypassed or cause an alarm at the end of the exit delay. If the option is turned on at this address then an unsealed condition will inhibit the panel from arming until the zone is sealed.

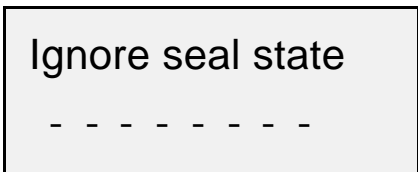

HIGH ZONE ASSIGNMENTS ZONES 9-16

P461E - P480E

Combinations of options in addresses P461E to P480E may be used to give the most suitable zone behaviour.

- P461E 1-8E Zone is in Area "A"** - Where options 1-8 represent zones 9-16 respectively. This option assigns a zone to Area "A" within a partitioned system. If the system is not partitioned, all zones must be assigned to Area "A". (Default all in Area "A") See P310E8E also.

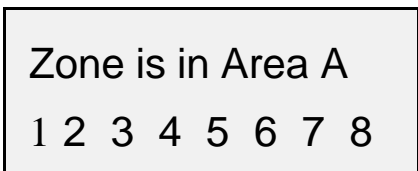

- P462E 1-8E Zone is in Area "B"** - Where options 1-8 represent zones 9-16 respectively. This option assigns a zone to Area "B" within a partitioned system. (Default none in Area "B") See P310E8E also.

If a zone is defined in both Area "A" and Area "B" it is deemed to be in Area "C"

- P463E 1-8E Zone is a normally open input** - where options 1-8 represent zones 9-16 respectively. This option is used when normally open detectors such as smoke detectors are to be connected to a

zone. The option only applies if zone doubling is turned On at P310E. Default is all zones normally closed.

- P464E 1-8E** **Zone is a radio detector** - Where options 1-8 represent zones 9-16 respectively. This option is used when Radio (wireless) devices are used as detectors. (Default none)
- P465E 1-8E** **Stay Mode Zones** - Where options 1-8 represent zones 9-16 respectively. Zones included at this address will become active when the panel is in Stay Mode. Zones not assigned at this address will be excluded. (Default 1-4) Note: Stay Mode Zones are linked to Area assignments
- P466E 1-8E** **Zone can be Bypassed** - Where options 1-8 represent zones 9-16 respectively. This option determines if a zone can be Bypassed either manually or via the Auto-Bypass process. (Default all on)
- P467E 1-8E** **Auto Bypass Zones** - Where options 1-8 represent zones 9-16 respectively. Zones assigned Auto Bypass function at this address will be automatically bypassed by the system if they are unsealed when the exit timers expire. Zones not given Auto Bypass status will cause an activation if they are unsealed at the end of the exit delay period. (Default all on)
- P468E 1-8E** **Zone is a handover** - Where options 1-8 represent zones 9-16 respectively. Zones defined at this address as handover are given the unique ability to behave as both delay and instant zones. If a zone defined as an entry delay zone has been activated and the entry delay is running, a handover zone will behave as another entry delay zone with a delay time as defined at P511E to P526E. If an entry delay zone has not been activated and there is no entry delay running, a handover zone becomes an instant zone with no entry delay. The Handover zone **MUST** have an entry delay programmed.

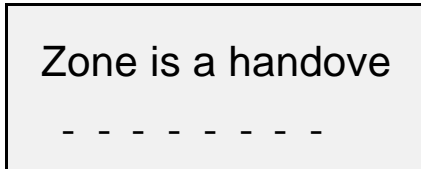

- P469E 1-8E** **Two Trigger Zones** - Where options 1-8 represent zones 9-16 respectively. A zone defined as two trigger at this address will only cause an activation if one of the following conditions are met;
 - a** The zone is triggered twice within the two trigger time period as defined by Address P534E, P535E or P536E
 - b** Any two zones defined as two trigger activate once each within the two trigger time period as defined by Address P534E, P535E or P536E
 - c** A zone defined as two trigger is left violated for longer than the two trigger time period as defined by Address P534E, P535E or P536E
- P470E 1-8E** **Zone is 24 Hour** - Where options 1-8 represent zones 9-16 respectively. 24 hour zones will activate whether the panel or partition is armed or disarmed. If an entry delay is also assigned to a 24 hr zone, the alarm will not trigger unless the zone is in alarm longer than the delay time programmed. (Default none)
- P471E 1-8E** **Zone is 24 Hour Fire Zone** - Where options 1-8 represent zones 9-16. 24 hour Fire zones will activate whether the panel or partition is armed or disarmed. If an entry delay is also assigned to a 24 hr Fire zone, the alarm will not trigger unless the zone is in alarm longer than the delay time programmed. A Fire Zone will cause the output to pulse to differentiate it from a burglar alarm. (Default none)



- P472E 1-8E** **Zone is 24 Hour Auto-Reset** - Where options 1-8 represent zones 9-16. 24 hour Auto-Reset zones will activate whether the panel or partition is armed or disarmed. If an entry delay is also assigned to a 24 hr Auto-Reset zone, the alarm will not trigger unless the zone is in alarm longer than the delay time programmed. An Auto-reset zone will seal automatically when the zone input is restored back to normal i.e. does not require a code to reset an alarm. (Default none)
- P473E 1-8E** **Day Zones** - Where options 1-8 represent zones 9-16 respectively. Day zones are active during periods where the panel or partitions are disarmed and revert to normal zones during armed periods (Default none)
- P474E 1-8E** **Continuous Day Zone** - Where options 1-8 represent zones 9-16 respectively. The zone acts as a day zone at all times (Armed and Disarmed) and will operate day alarms but not normal

- zone alarms (Default none)
- P475E 1-8E Siren Lockout Zones**- Where options 1-8 represent zones 9-16 respectively. Zones with siren lockout designation will only cause their assigned outputs to operate once per armed period. Led on = zone locked out. (Default none)
- P476E 1-8E Access Control door position input** - Where options 1-8 represent zones 9-16 respectively. The door position input becomes a 24 hour alarm zone and will alarm if the "Control" door is forced open or left open too long. It will also automatically re-lock the door after the "Control" operation has occurred and the door has been opened then closed again. (Default none)
- P477E 1-8E Access Control Request to exit input** - Where options 1-8 represent zones 9-16 respectively. The Request to Exit input will operate the "Control" door output to release the door and start the Door open Too long Timer. (Default none)
- P478E 1-8E Zone will report multiple activations to communicator** - Where options 1-8 represent zones 9-16 respectively. If this option is turned off then the relevant zone will only report one alarm to a monitoring company during any single armed period. If it is turned on, the zone can send multiple reports if activated more than once during a single armed period.
- P479E 1-8E Zone will be Monitored for Inactivity** - Where options 1-8 represent zones 9-16 respectively. A Zone with this option turned on will be checked to ensure that it is triggered on a regular basis. If the zone is not triggered within the time period set at P569E then an alarm will be generated as the detector may have become faulty or could be masked. The timer period as set at address P569E is only active during the disarmed period. If the timer has started due to inactivity of a zone input, the elapsed time is remembered at the time of arming and will resume when the alarm is disarmed.
- P480E 1-8E Cannot Arm if Zone is Unsealed** - Where options 1-8 represent zones 9-16 respectively. If a zone is unsealed (Not Ready) at the time of arming, by default the panel will Arm and the zone will either automatically be bypassed or cause an alarm at the end of the exit delay. If the option is turned on at this address then an unsealed condition will inhibit the panel from arming until the zone is sealed.

PROGRAMMING DELAYS & TIMERS

ZONE ENTRY DELAY TIMES - P511E to P526E

- P511E 0-9999E Zone 1 entry delay** - 0-9999 seconds - default 20 seconds
- P512E 0-9999E Zone 2 entry delay** - 0-9999 seconds - default 20 seconds
- P513E 0-9999E Zone 3 entry delay** - 0-9999 seconds - default 0 (Instant)
- P514E 0-9999E Zone 4 entry delay** - 0-9999 seconds - default 0 (Instant)
- P515E 0-9999E Zone 5 entry delay** - 0-9999 seconds - default 0 (Instant)
- P516E 0-9999E Zone 6 entry delay** - 0-9999 seconds - default 0 (Instant)
- P517E 0-9999E Zone 7 entry delay** - 0-9999 seconds - default 0 (Instant)
- P518E 0-9999E Zone 8 entry delay** - 0-9999 seconds - default 0 (Instant)
- P519E 0-9999E Zone 9 entry delay** - 0-9999 seconds - default 0 (Instant)
- P520E 0-9999E Zone 10 entry delay** - 0-9999 seconds - default 0 (Instant)
- P521E 0-9999E Zone 11 entry delay** - 0-9999 seconds - default 0 (Instant)
- P522E 0-9999E Zone 12 entry delay** - 0-9999 seconds - default 0 (Instant)
- P523E 0-9999E Zone 13 entry delay** - 0-9999 seconds - default 0 (Instant)
- P524E 0-9999E Zone 14 entry delay** - 0-9999 seconds - default 0 (Instant)
- P525E 0-9999E Zone 15 entry delay** - 0-9999 seconds - default 0 (Instant)
- P526E 0-9999E Zone 16 entry delay** - 0-9999 seconds - default 0 (Instant)

Zone 1 Entry Dela

20

AREA EXIT DELAY TIMES - P531E to P533E

- P531E 0-999E Area "A" exit delay** - 0-999 seconds - Default 60 seconds
- P532E 0-999E Area "B" exit delay** - 0-999 seconds - Default 60 seconds
- P533E 0-999E Area "C" exit delay** - 0-999 seconds - Default 60 seconds

Zone 1 Exit Delay

60

TWO TRIGGER TIMERS - P534E to P536E

- P534E 0-999E Area "A" Two Trigger time period** - Default 60 seconds
- P535E 0-999E Area "B" Two Trigger time period** - Default 60 seconds
- P536E 0-999E Area "C" Two Trigger time period** - Default 60 seconds

STAY MODE ENTRY DELAY TIMES - P540E to P542E

- P540E 0-999E Area "A" Special Stay Mode entry delay** - Default 20 seconds
- P541E 0-999E Area "B" Special Stay Mode entry delay** - Default 20 seconds
- P542E 0-999E Area "C" Special Stay Mode entry delay** - Default 20 seconds

DAY ZONE TO KEYPAD BUZZER TIMES - P543E to P545E

P543E 1-999E Area "A" Day Zone keypad buzzer duration - Default 2 seconds
P544E 1-999E Area "B" Day Zone keypad buzzer duration - Default 2 seconds
P545E 1-999E Area "C" Day Zone keypad buzzer duration - Default 2 seconds

P546E 1-999E Area "A" Day Zone to Output duration - Default 2 seconds
P547E 1-999E Area "B" Day Zone to Output duration - Default 2 seconds
P548E 1-999E Area "C" Day Zone to Output duration - Default 2 seconds

OUTPUT RESETS TIMES - P551E to P558E

P551E 0-999E Output #1 reset time - Default 600 seconds (10 min)
P552E 0-999E Output #2 reset time - Default 600 seconds (10 min)
P553E 0-999E Output #3 reset time - Default 600 seconds (10 min)
P554E 0-999E Output #4 reset time - Default 600 seconds (10 min)
P555E 0-999E Output #5 reset time - Default 0 (latching)
P556E 0-999E Output #6 reset time - Default 0 (latching)
P557E 0-999E Output #7 reset time - Default 0 (latching)
P558E 0-999E Output #8 reset time - Default 0 (latching)

Output 1 reset on ti
300

P559E 0-999E Mains Fail Dialler Report Delay - Default 600 seconds

P560E 0-999E Zone Alarm Report Delay to Dialler - Default 0 seconds

OUTPUT DELAY ON TIMES - P561E to P568E

P561E 0-999E Output #1 delay on timer - Default 0 (instant)
P562E 0-999E Output #2 delay on timer - Default 0 (instant)
P563E 0-999E Output #3 delay on timer - Default 0 (instant)
P564E 0-999E Output #4 delay on timer - Default 0 (instant)
P565E 0-999E Output #5 delay on timer - Default 0 (instant)
P566E 0-999E Output #6 delay on timer - Default 0 (instant)
P567E 0-999E Output #7 delay on timer - Default 0 (instant)
P568E 0-999E Output #8 delay on timer - Default 0 (instant)

Output 1 delay on t
0

P569E 0-999E Zone Inactivity Timer (0-999 hours) - Default 120 hours

SUPERVISED RADIO SIGNAL TIME - P570E

P570E 0-999E Supervised Radio Timer (0-999 minutes) - Default 240 minutes

OUTPUT PULSE TIMES - P571E to P578E

P571E 0-999E Output #1 pulse time -Default 0 (0 = Minimum 0.1 sec pulse) Times are in 1/10 second
P572E 0-999E Output #2 pulse time -Default 0 (0 = Minimum 0.1 sec pulse) increments
P573E 0-999E Output #3 pulse time -Default 0 (0 = Minimum 0.1 sec pulse)
P574E 0-999E Output #4 pulse time -Default 0 (0 = Minimum 0.1 sec pulse)
P575E 0-999E Output #5 pulse time -Default 0 (0 = Minimum 0.1 sec pulse)
P576E 0-999E Output #6 pulse time -Default 0 (0 = Minimum 0.1 sec pulse)
P577E 0-999E Output #7 pulse time -Default 0 (0 = Minimum 0.1 sec pulse)
P578E 0-999E Output #8 pulse time -Default 0 (0 = Minimum 0.1 sec pulse)

PW ACCESS CONTROL

The PW16 provides a basic Access Control function which utilises the keypad "Control" Function, one of the outputs as a switching device and separate zone inputs as Request-to-Exit and door position monitoring. Address P456E or P476E are used to assign a zone to be the door position monitor input and address P457E or P477E are used to assign a zone as the request to exit input. Once options have been programmed, a door which is fitted with a reed switch, monitored by the zone as defined at P456E or P476E will cause a 24 hour alarm if it is opened without the Control Function being operated. Once the control function has been operated with a valid code, a door open too long (DOTL) timer is started and if the door is not closed again within the time determined by P537E (Area "A"), P538E (Area "B") or P539E (Area "C") a 24Hr alarm will be created. The control function to output mapping is defined at addresses P291E through P298E for Area "A", P391E through P398E for Area "B" and P491E through P498E for Area "C".

P537E 1-999E Area "A" door open too long time period - default 10 sec
P538E 1-999E Area "B" door open too long time period - default 10 sec
P539E 1-999E Area "C" door open too long time period - default 10 sec

PROGRAMMING RADIO DETECTORS

ENROLLING RADIO DETECTORS - P620E 1-16E

This address is where radio PIR's and other wireless detectors are enrolled into the PW16 and assigned to zones. Assigning a zone as radio at addresses P444E & P464E will enable the zone as a wireless zone and disable the hardwired zone input at the terminals on the control board.

To load a radio detector whilst in installer program mode, for example Zone 1, press P620E1E. The keypad will beep at 1 second intervals and the green learn mode LED on the Radio receiver board will flash on & off. Trigger the detector you wish to enrol at this address (Zone 1) The keypad will stop beeping and the receiver learn LED will go out when the detectors code has been stored. Repeat this sequence for all of the radio detectors moving through the addresses which correspond to the zones you require.

For example;

P620E2E	Radio Zone #2
P620E3E	Radio Zone #3
P620E16E	Radio Zone #16

To delete a single radio code, repeat the learning process above but while in learn mode press the "Enter" button, while no transmitters are operating, and this will remove any radio code from that address.

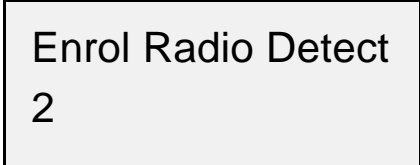

RADIO ZONE DETECTORS OPTIONS

SET RADIO DETECTOR OPTIONS - P621E - P636E

This block of addresses is used to specify a specific type of radio detector. Special functions such as detector tamper alarms, low battery indication and supervised signals can be selected based on the list below.

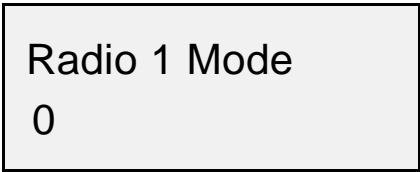

- 1 = Crow AE Series Battery low
- 2 = Crow AE Radio Reed Switch
- 3 = Crow Merlin PIR (Non-supervised)
- 4 = Crow Merlin PIR (supervised signal active)
- 5 = Crow Merlin /Checksum (supervised sig. active)
- 6 = Crow Merlin /Checksum (supervised sig. Ignored)
- 11 = Ness Devices battery Low
- 12 = Ness Radio Reed Switch
- 21 = Electronics Line Radio PIR
- 31 = Visonic K900 Radio PIR

Where P621E assigns options to the radio detector at zone 1, P622E assigns options to the radio detector at zone 2 etc.

- | | | | |
|-------|-------------------------------|-------|--------------------------------|
| P621E | Radio detector zone 1 options | P629E | Radio detector zone 9 options |
| P622E | Radio detector zone 2 options | P630E | Radio detector zone 10 options |
| P623E | Radio detector zone 3 options | P631E | Radio detector zone 11 options |
| P624E | Radio detector zone 4 options | P632E | Radio detector zone 12 options |
| P625E | Radio detector zone 5 options | P623E | Radio detector zone 13 options |
| P626E | Radio detector zone 6 options | P634E | Radio detector zone 14 options |
| P627E | Radio detector zone 7 options | P635E | Radio detector zone 15 options |
| P628E | Radio detector zone 8 options | P636E | Radio detector zone 16 options |

ENROLLING RADIO KEYS

ENROLLING RADIO KEYS - P640E 1-20E

In the PW16 V6 we refer to wireless pendant transmitters as "Radio Keys". Because the PW16 recognises each button as a separate function or user we refer to each button or user separately in that if you are loading a three button radio key, you would actually be enrolling 3 separate radio users. It is possible to enrol several radio users as one where you are able to program the transmitter code of the radio key (usually via dip switches) to key them alike. Where you can not program the transmitter code of the radio keys you must enrol them as separate users.

To load a radio key whilst in installer program mode, for example radio key 1, press P640E1E. The keypad will beep at 1 second intervals and the green learn mode LED on the Radio receiver board will flash on & off. Trigger the transmitter you wish to enrol at this address (Radio key 1). The keypad will stop beeping and the receiver learn LED will go out when the transmitters code has been stored. Repeat this sequence for all of the radio keys moving through the addresses which correspond to the keys you require.

For example; P640E2E Radio Key #2
 P640E3E Radio Key #3
 P640E20E Radio Key #20

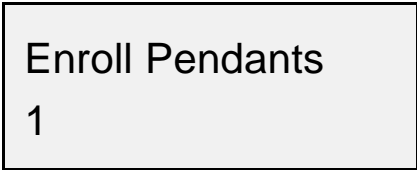

To delete a single radio key, repeat the learning process above but while in learn mode press the "Enter" button, while no transmitters are operating, and this will remove any radio key code from that address.

RADIO KEYS OPTIOS A

RADIO KEY OPTIONS 1st Set - P661E - P680E

In the same way that permissions are set for user codes, Radio Keys are also assigned permissions which determine their functionality.

- P661E 1E Radio user #1 has Area "A" permissions (Default all)
- 2E Radio user #1 has Area "B" permissions
- 3E Radio user #1 has Area "C" permissions
- 4E Radio user #1 will arm
- 5E Radio user #1 will disarm
- 6E Radio user #1 can Arm Stay Mode on
- 7E Radio user #1 can Disarm Stay Mode off
- 8E Radio user #1 is disabled during alarm state

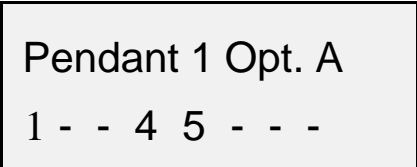

- Option 1** Radio user #1 has Area "A" permissions - The functions set by options 4-7 will be active in Area "A"
- Option 2** Radio user #1 has Area "B" permissions - The functions set by options 4-7 will be active in Area "B"
- Option 3** Radio user #1 has Area "C" permissions - The functions set by options 4-7 will be active in Area "C"
- Option 4** Radio user #1 will arm - When this option is enabled, radio user #1 will arm whichever area is assigned by options 1-3
- Option 5** Radio user #1 will disarm - When this option is enabled, radio user #1 will disarm whichever area is assigned by options 1-3
- Option 6** Radio user #1 can Arm Stay Mode - When this option is enabled, radio user #1 will turn Stay Mode on in whichever area is assigned by options 1-3
- Option 7** Radio user #1 can Disarm Stay Mode - When this option is enabled, radio user #1 will turn Stay Mode off in whichever area is assigned by options 1-3
- Option 8** Radio user #1 is disabled during alarm state - When this option is enabled, radio user #1 can not be used to reset an alarm, i.e. it must be reset at the keypad.

Where P661E sets options for radio user #1, P662 sets options for radio user #2 etc

RADIO KEY TYPE

P641E - P660E

Radio Keys are also assigned permissions which determine their functions

P641E	Radio user #1 Type - Default 0	0 = non-specific
P642E	Radio user #2 Type - Default 0	1 = Crow
P643E	Radio user #3 Type - Default 0	21 = Ness
P644E	Radio user #4 Type - Default 0	31 = Visonic
P659E	Radio user #19 Type - Default 0	
P660E	Radio user #20 Type - Default 0	

RADIO KEYS OPTIOS B

RADIO KEY OPTIONS 2nd Set - P681E - P700E

P681E	1E	Radio user #1 turns control function on
	2E	Radio user #1 turns control function off (Toggles if 1 on)
	3E	Radio user #1 turns output on
	4E	Radio user #1 turns output off (Toggles if 3 ON)
	5E	Radio user #1 is instant panic
	6E	Radio user #1 is delayed panic (1.5 sec)
	7E	Spare
	8E	Spare

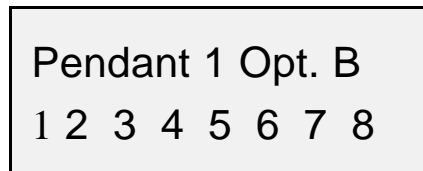

- Option 1** **Radio user #1 turns control function on** - When this option is enabled, the radio user will turn on the Control Function as if it were operated from the keypad.
- Option 2** **Radio user #1 turns control function off** - When this option is enabled, the radio user will turn the control output off as if it were operated from the keypad. (Dependant on control options)
- Option 3** **Radio user #1 turns output on** - When this option is enabled, the radio user will turn on the output as assigned by P701E.
- Option 4** **Radio user #1 turns output off** - When this option is enabled, the radio user will turn off the output as assigned by P701E. This function is only valid when there is no reset time assigned to the output in question.
- Option 5** **Spare**
- Option 6** **Radio user #1 is instant panic** - When this option is enabled, the radio user will produce an instant panic.
- Option 7** **Radio user #1 is delayed panic** - When this option is enabled, the radio user will produce a delayed panic after transmitting continuously for 1.5 seconds.
- Option 8** **Radio user #1 NESS 24 bit radio key battery low** - This option is used to enable the low battery reporting feature of the NESS 24 bit 3 button radio key.

Where P681E sets the second set of options for radio user #1, P682 sets options for radio user #2 etc

P681E	Radio user #1 options	P691E	Radio user #11 options
P682E	Radio user #2 options	P692E	Radio user #12 options
P683E	Radio user #3 options	P693E	Radio user #13 options
P684E	Radio user #4 options	P694E	Radio user #14 options
P685E	Radio user #5 options	P695E	Radio user #15 options
P686E	Radio user #6 options	P696E	Radio user #16 options
P687E	Radio user #7 options	P697E	Radio user #17 options
P688E	Radio user #8 options	P698E	Radio user #18 options
P689E	Radio user #9 options	P699E	Radio user #19 options
P690E	Radio user #10 options	P700E	Radio user #20 options

MAPPING RADIO USERS TO OUTPUTS

P701E to P720E

This block of addresses is used to map radio users to outputs in conjunction with P681E - P700E. All output modifiers such as reset timers and lock out functions are maintained and will determine the behaviour of the assigned output.

-]
- P701E 1-8E Radio user #1 to output 1-8 - Where options 1-8 represent outputs 1-8
 - P702E 1-8E Radio user #2 to output 1-8 - Where options 1-8 represent outputs 1-8
 - P703E 1-8E Radio user #3 to output 1-8 - Where options 1-8 represent outputs 1-8
 - P704E 1-8E Radio user #4 to output 1-8 - Where options 1-8 represent outputs 1-8
 - P705E 1-8E Radio user #5 to output 1-8 - Where options 1-8 represent outputs 1-8
 - P706E 1-8E Radio user #6 to output 1-8 - Where options 1-8 represent outputs 1-8
 - P707E 1-8E Radio user #7 to output 1-8 - Where options 1-8 represent outputs 1-8
 - P708E 1-8E Radio user #8 to output 1-8 - Where options 1-8 represent outputs 1-8
 - P709E 1-8E Radio user #9 to output 1-8 - Where options 1-8 represent outputs 1-8
 - P710E 1-8E Radio user #10 to output 1-8 - Where options 1-8 represent outputs 1-8
 - P711E 1-8E Radio user #11 to output 1-8 - Where options 1-8 represent outputs 1-8
 - P712E 1-8E Radio user #12 to output 1-8 - Where options 1-8 represent outputs 1-8
 - P713E 1-8E Radio user #13 to output 1-8 - Where options 1-8 represent outputs 1-8
 - P714E 1-8E Radio user #14 to output 1-8 - Where options 1-8 represent outputs 1-8
 - P715E 1-8E Radio user #15 to output 1-8 - Where options 1-8 represent outputs 1-8
 - P716E 1-8E Radio user #16 to output 1-8 - Where options 1-8 represent outputs 1-8
 - P717E 1-8E Radio user #17 to output 1-8 - Where options 1-8 represent outputs 1-8
 - P718E 1-8E Radio user #18 to output 1-8 - Where options 1-8 represent outputs 1-8
 - P719E 1-8E Radio user #19 to output 1-8 - Where options 1-8 represent outputs 1-8
 - P720E 1-8E Radio user #20 to output 1-8 - Where options 1-8 represent outputs 1-8

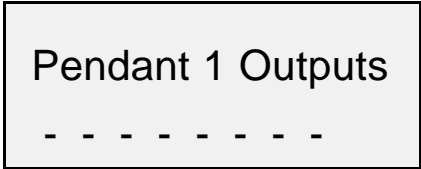

PROGRAMMING TIME ZONES

This block of addresses is used to define the time zones used by outputs, users and the Auto Arm/Disarm feature. Time zones require a start and a finish time with the effective window as the difference between start and finish. For this reason the finish time value must be higher than the start value. All times are set in 24 hour clock format.

- P791E 1-8E** **TZ1 days of the week** - Where 1-7 represent the days of the week which the time zone will operate where 1 = Sunday, 2 = Monday etc. A value of 8 at this address will invert the TZ function so that instead of being effective during the window created by the start and finish times, the TZ is effective during the times outside the window set by the start and finish times.

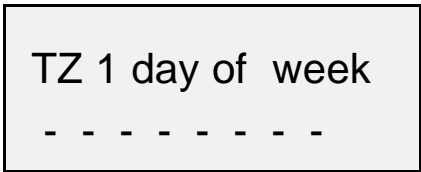

- P792E 0000 - 2359E** **TZ1 Start time** - This is the time when the TZ will start. Use 24 hour format. (HHMM)
- P793E 0000 - 2359E** **TZ1 Finish time** - This is the time of day when the TZ will finish. The finish time must be greater than the start time. Use 24 hour format. (HHMM)

There are 8 time zones available and they occupy addresses P791E to P814E. Each time zone requires 3 addresses to be assigned.

- | | | | |
|-------|---------------------|-------|---------------------|
| P791E | TZ1 Day of the week | P803E | TZ5 Day of the week |
| P792E | TZ1 Start Time | P804E | TZ5 Start Time |
| P793E | TZ1 Finish Time | P805E | TZ5 Finish Time |
| P794E | TZ2 Day of the week | P806E | TZ6 Day of the week |
| P795E | TZ2 Start Time | P807E | TZ6 Start Time |

P796E TZ2 Finish Time
P797E TZ3 Day of the week
P798E TZ3 Start Time
P799E TZ3 Finish Time
P800E TZ4 Day of the week
P801E TZ4 Start Time
P802E TZ4 Finish Time

P808E TZ6 Finish Time
P809E TZ7 Day of the week
P810E TZ7 Start Time
P811E TZ7 Finish Time
P812E TZ8 Day of the week
P813E TZ8 Start Time
P814E TZ8 Finish Time

PROGRAMMING DAYLIGHT SAVING

P817E - P822E

Given that your PW16 controller has a real time clock compliant with minutes & hours of the day, days of the week and months of the year, it is only reasonable to assume automatic adjustments for daylight saving. This block of addresses provides the PW16 with the information required to perform the daylight saving adjustments as required.

- P817E 0-5E Daylight Saving Start Sunday** - This is the Sunday number in the month that daylight saving will begin (values of 1-5 are allowed). Default = 1
- P818E 0-12E Daylight Saving Start Month** - This is month in which the above Sunday will occur. (Values of 1-12 are allowed). Default = 10
- P819E 0-24E Daylight Saving Start Hour** - This is the hour that daylight savings will begin (values of 0-24 are allowed). Default = 2
- P820E 0-5E Daylight Saving End Sunday** - This is the Sunday number in the month that daylight savings will end (values of 1-5 are allowed). Default = 3
- P821E 0-12E Daylight Saving End Month** - This is the month in which the Sunday number will occur (values of 1-12 are allowed). Default = 3
- P822E 0-24E Daylight Saving End Hour** - This is the hour that daylight savings will end (values of 0-24 are allowed). Default = 3

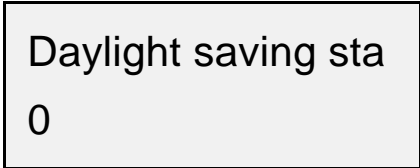

DYNAMIC DIAGNOSTIC DATA

P830E - P833E & P849E

These addresses are used to provide real time feedback from the panel as to the current status. These are intended as view only addresses and only available in installer program mode.

- P830E Misc System Flags** - This address currently has only one option that shows the status of Daylight Saving. If LED 8 is On then Daylight Saving is currently active.
8 = Daylight Saving active
- P831E Display keyboard address** - This option will cause the keypad you are operating to display it's currently assigned address from 1-8. This feature is only available in installer program mode.
- P832E Display partitions assigned to this keypad** - This option will cause the keypad you are operating to display it's currently assigned Areas. This feature is only available in installer program mode.
- P833E Display software version** - This address will cause the panel software version to be flashed back at the keypad.
- P849E Active Time-Zones** - If Time Zones are being used, by entering in this address while in Installation Program Mode the panel will display any of the 8 time zones currently active. If LED's 1-8 are On they indicate active time zones.

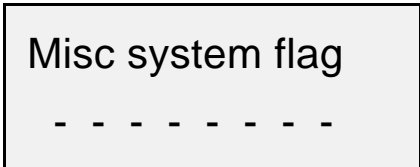

SETTING THE REAL TIME CLOCK

P823E - P827E

These addresses are used to set the internal real time clock used by the time zone functions, time & date stamping of events in the event buffer and the time for any automatic test calls to a monitoring station.

P823E	1-7E	Set day of the week - where values of 1-7 represent Sunday to Saturday (Sunday = 1)
P824E	0000 - 2359E	Set time - Use 24 hour format
P825E	1-31E	Set day of the month - where values of 1-31 represent days in the month.
P826E	1-12E	Set Month - where values of 1-12 represent the month.
P827E	0-99	Set Year - Where 0-99 represent years, i.e. 02 = 2002.

Day of the week
2

TEMPORARY OUTPUT DISABLE

P837E

Temporary Output Disable - This address allows a technician to select any output/s to be temporarily disabled for one alarm or armed cycle, e.g. by turning on LEDS 1-8 at P837E then leaving program mode, outputs 1-8 will not turn on following any alarms. The technician is now free to arm the system to test all monitoring signals without having all of the internal & external alarms activating. When the alarm is reset or disarmed all outputs will now work normally again.

Output Disable
- - - - -

EE² LOCAL UP/DOWN LOAD

P838E

Write to EE² Board - with the optional back-up EE² board plugged into the serial connector on the panel and the write enable link fitted on the EE² board, entering P838E will write a copy of the panel program files to the EE² board.

P839E

Read from EE² Board - this address allows a copy of a panel program files to be downloaded into a panel (the program files must first have been copied to the EE² board - refer P838E). Note: When transferring data from this board to a panel, the software versions of the two panels (the one where the data files were created and the panel receiving the files) must be the same otherwise the panel will not work correctly.

Read from EE
2 3 4 5 6 7 8

DE-MAPPING OUTPUTS

P846E 1-8E

DE-mapping Outputs 1-8 - This option is used to remove ALL default options assigned to any output. This is a particularly useful tool when reassigning outputs to special functions such as smoke detector reset, where you need to remove the standard defaults from an output. In addition to removing all default programming this option will also make the reset time for the selected output/s "0".

Clear all outputs

0

RESET TO DEFAULTS

P840E - P848E

These addresses are used to reset sections of the programming back to defaults. Defaults are the factory settings. Most of the addresses below default only one part of the programming. To reset the entire configuration, including the event memory buffer you must use P845E.

P840E Reset user codes

P841E Reset dialler parameters

P842E Reset Radio parameters

P843E Reset PA & Voice board settings

P844E Reset the balance of the panel settings not included above

P845E Reset all panel parameters to default and clear the event memory buffer

P847E Clear event memory

P848E Reset PA board to clear all existing alarm messages

Reset Communicat

START EVENT PRINTING

P834E **Start Event Printing** - The alarm system stores the last 255 events in a printer buffer. These events include time, date and an event description. To print the events, assuming the Serial Board is plugged into the panel (with the link set to printer on the serial board) and connected to a printer with a RS232 input, a user with permission to print (e.g. P101-P150 option 4) enters client program mode (P-code-E, program LED on solid), then enters P834E, the entire contents of the event buffer will be sent to the printer.

Event Printing

WALK-TEST MODE

P836E **Walk-test mode** - When in Installation or Client Program mode, entering P836E will turn On walk-test mode. The keypad buzzer will beep at one second intervals to show that walk-test mode is active. When in walk test mode the zone LED's will latch on at the keypad display when the zone has been activated. The Installer or User can then walk past all of the detectors and return to the keypad to verify that they are functioning correctly at the panel. The walk-test results are also stored in memory so they can be viewed at a later time if required. Pressing any button will terminate walk-test mode.

Walk Test

COMMAND CONTROL CODE PROGRAMMING

Another powerful feature available from your PW16 V6 control communicator is Command Control. This feature is a remote control facility which allows valid users to access the panel via a standard touch tone telephone and check or change the Arm/Disarm status of each of the areas, operate each of the eight outputs or turn on an optional Microphone.

The Command Control feature is only available on panels fitted with a Voice or DTMF board (see page 15). The Voice board provides voice prompts to guide you through Command control operations whereas the DTMF board provides tones (one Long Tone for ON or three short beeps for OFF). In some installations voice message storage space will be shared between the speech dial alarm event messages and the command control status messages.

Before Command Control features can be used the 4 digit DTMF control codes must be programmed. The DTMF codes can be 1-4 digits in length. There is a code for each partition, another to control all of the 8 outputs and one more to turn on or off the optional Microphone input. When programming the command control messages, ensure that the messages are a minimum of 2 seconds long. The addresses for these codes are;

- P371E code E 4 Digit Code for Output Command Control** - This is the code used to access the Output Command menu. A number from 1-8 is entered after this code to select the output you wish to control (for this feature to work, option 5 at addresses P201E to P208E must be turned on).
- P372E code E 4 Digit Code for Area "A" Command Control** - This is the code used to Arm or Disarm Area "A" via the telephone.
- P373E code E 4 Digit Code for Area "B" Command Control** - This is the code used to Arm or Disarm Area "B" via the telephone.
- P374E code E 4 Digit Code for Area "C" Command Control** - This is the code used to Arm or Disarm Area "C" via the telephone.
- P375E code E 4 Digit Code to Turn ON Microphone** - This is the code used to turn the microphone input on so that the user can listen to any foreign sounds at the secured premises.

Area B CMD Code 0

RECORDING STATUS MESSAGES

The Command Control messages are recorded into the voice board using the plug-in speech programmer in the same way as alarm reporting messages are stored (refer to page 15). In general, to save confusion, it is advisable to record all of the alarm reporting messages first then record the Command Control messages. When recording the command control messages the **ON** message **MUST** always be recorded **FIRST** followed immediately by the **OFF** message e.g. For the Area "A" command control messages the Area A Armed message must be recorded first followed by the Area A Disarmed message. The same rule applies to the outputs in that the output ON message must be recorded first followed by the Outputs' OFF message. This is because the panel is told where to find the On message Number for a specific Command Control function and it then is assumed that the OFF message is the next message.

ON MESSAGE FOR ARM/DISARM STATUS MESSAGES

If the ON message number is left blank i.e. "0", the panel will assume that there is no voice message for this Command Control function and revert to the DTMF board tones e.g. One long tone for ON and three short beeps for OFF.

- P777E code E Area "A" ON message number** - This is the message number where the Area "A" armed message starts. The Area "A" disarmed message must be the next message.
- P778E code E Area "B" ON message number** - This is the message number where the Area "B" armed message starts. The Area "A" disarmed message must be the next message.
- P779E code E Area "C" ON message number** - This is the message number where the Area "C" armed message starts. The Area "A" disarmed message must be the next message.

Area A status Msg 0

ON MESSAGE FOR OUTPUT STATUS MESSAGES

If the ON message number is left blank i.e. "0", the panel will assume that there is no voice message for this Command Control function and revert to the DTMF board tones e.g. One long tone for ON and three short beeps for OFF.

- P781E code E Output #1 ON message number** - This is the message number where the Output #1 ON message starts. The Output #1 OFF message must be the next message.
- P782E code E Output #2 ON message number** - This is the message number where the Output #2 ON message starts. The Output #2 OFF message must be the next message.
- P783E code E Output #3 ON message number** - This is the message number where the Output #3 ON message starts. The Output #3 OFF message must be the next message.
- P784E code E Output #4 ON message number** - This is the message number where the Output #4 ON message starts. The Output #4 OFF message must be the next message.
- P785E code E Output #5 ON message number** - This is the message number where the Output #5 ON message starts. The Output #5 OFF message must be the next message.
- P786E code E Output #6 ON message number** - This is the message number where the Output #6 ON message starts. The Output #6 OFF message must be the next message.
- P787E code E Output #7 ON message number** - This is the message number where the Output #7 ON message starts. The Output #7 OFF message must be the next message.
- P788E code E Output #8 ON message number** - This is the message number where the Output #8 ON message starts. The Output #8 OFF message must be the next message.

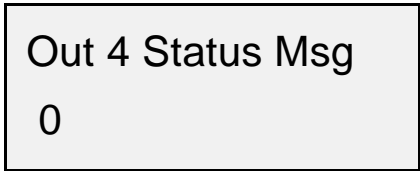

EXAMPLE OF HOW THE COMMAND CONTROL MESSAGE ADDRESSING WORKS.

We have assumed that there are 3 voice alarm reporting messages programmed for warning of alarm conditions via the telephone. These messages could be;

- Message #1 *"Burglar alarm at Acme Building Products"*
- Message #2 *"Fire alarm at Acme Building Products"*
- Message #3 *"Panic alarm at Acme Building Products"*

Next, we require arm/disarm capability for Areas A & B plus we need to be able to turn Outputs 5 & 8 On and Off remotely. The messages could be set-up as follows;

- Message #4 *"Area A alarm is Armed"*
 - Message #5 *"Area A alarm is Disarmed"*
 - Message #6 *"Area B alarm is Armed"*
 - Message #7 *"Area B alarm is Disarmed"*
 - Message #8 *"External lights are On" (external lights are connected to Output 5)*
 - Message #9 *"External lights are Off" (external lights are connected to Output 5)*
 - Message #10 *"After hours delivery gate is unlocked" (electric gate lock is connected to Output 8)*
 - Message #11 *"After hours delivery gate is locked" (electric gate lock is connected to Output 8)*
- (Please Note that the ON message is always programmed first)

Now, to access the correct message for the desired Command Control function we have to program the start message numbers for each function.

The programming to match the above example would be done as follows;

- P777E 4E** Message # 4. (Area A ON status message)
- P778E 6E** Message # 6. (Area B ON status message)
- P785E 8E** Message # 8. (Output # 5 ON status message)
- P788E 10E** Message # 10. (Output # 8 ON status message)

COMMAND CONTROL OPERATION

PW16 Command Control provides a powerful, easy to use remote telephone control of your alarm system. User operation of the PW16 Command Control has been designed to be as simple and user friendly as possible. Pre-recorded voice status messages guide you through the many control options, or the more simplified DTMF only board gives you long and short tones providing a status report of the section of the system which you are currently commanding. Because the voice status messages are recorded on-site they can be customised to suit each specific application. For example, rather than the status message saying "Output #1 off" you can record a message which describes exactly what is being controlled like "Factory heating off"

In the previous section you would have seen how you program access codes for each of the Command Areas and outputs. These are the codes you will enter over the phone to access the command menus. In order to start the Command Control feature you must first ring the phone number which the panel is connected to. The panel may be set up to answer after a specific number of rings or it may be set-up to use a fax defeat option. Either way, when you ring the phone number and finally get through to the PW16, the first thing you will hear over the phone is a burst of modem tone for two seconds. After this tone has stopped you must enter the access code which is associated with the Command menu option you wish to access. *Remember, the code you enter will determine which menu option you access.* If you miss the pause, the communicator will repeat the modem tone and then again pause for 5 seconds looking for your access code. This process will be repeated 4 times before hanging up if no valid code is received. When entering codes or other information in Command Control the "#" key acts as a "Clear" button.

When you have entered the required 4 digit access code the panel will reply with the status message associated with that menu option. For example, let's say we have a code of 2045 programmed at address P372E, (the code for Arming & Disarming Area A). Once the code "2045" has been received the panel checks the current status of Area A and replies with the pre-programmed voice message programmed at address P777E relating to that status e.g. if Area A is Armed then the Armed message will be sent, if Disarmed then the Disarmed message will be sent. If the data at address P777E is "0" then the panel will give a long beep if Area A is Armed, and three short beeps if it is disarmed.

Once the status message has informed you of the actual state, you can use the "*" key to toggle the option on & off or Arm and Disarm, e.g. in our example above, code 2045 accesses the Area "A" menu. Assuming the status message we received was "Area A alarm is Armed" If we press the "*" key, Area "A" will be Disarmed and we would receive a status message "Area A alarm is Disarmed".

While you are on-line with the panel you can move between menu options by entering the code of the option you want to control. Assuming there was a code of 4321 programmed at address P371E, to control outputs. After having used code 2045 to control the Arm/Disarm status of Area A we can then enter the digits 43215 that will allow you to control Output #5. The current status of output #5 will be given either by the voice message or the appropriate tone and then the status can be changed with the "*" button on the remote telephone (Note; For output control you must enter in the 4 digit code e.g. 4321 followed by the output number you wish to control, in this case 5).

At any stage, if you enter in an incorrect code you can press the "#" button on the remote telephone to clear all code entries and then start again.

To end a Command Control session simply hang up the phone. The panel is monitoring the line at all times and 15 seconds after the last key press it will automatically hang up the line. This 15 second timer is active during the whole command control process so a period of 15 seconds without a key press will cause the panel to hang-up.

LOCAL COMMAND CONTROL OF OUTPUTS

If a command control code for outputs is programmed (P371E) and the output/s are allowed to be locally controlled (P201-P208, option 6) then entering the 4 digit code at a keypad will blank the display and the zone LED's will now indicate the output status e.g. if output 1 is on zone 1, led will be on. By now pressing the "1" button at the panel keypad, output 1 can be turned off provided it is allowed to be locally controlled. To leave local command control mode simply press the "Enter" button and the keypad will return to normal operation. If option 8 at addresses P301, P401 or P501 are on, you can access this Local Command Control mode directly by simply pressing the "Control" button at the keypad followed by the output number/s that are allowed to be controlled.

DIALLER PROGRAMMING

ENABLING DIALLER & SETTING DIALLING PARAMETERS - P370E

P370E 1-8E System Options (Default = 7)

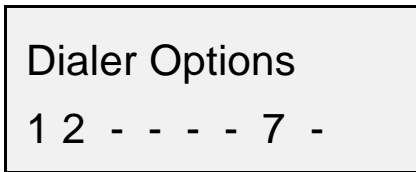

- 1 = Enable dialler
- 2 = Fax defeat
- 3 = Disable line monitoring
- 4 = DTMF or Pulse Dial
- 5 = Normal or Reverse Pulse Dial
- 6 = Spare
- 7 = Auto-Detect Modem Format
- 8 = Force Bell103/V21

- Option 1** **Enable Dialler** - This option is used to activate the dialler hardware. If this option is Off, all dialler reporting activity will be disabled. - Default = Off
- Option 2** **Fax Defeat** - This option enables fax defeat mode. When enabled the panel will look for incoming rings between 1-4 rings (inclusive). If the incoming call is then terminated the panel will answer the next incoming call after one ring. If another call is not established within 45 sec of the first call, the fax defeat mode is reset. For fax defeat to work the auto answer rings must be enabled by putting in a suitable ring count (e.g. 25).
- Option 3** **Disable Line Monitoring** -If this option is enabled, then the panel no longer tests the telephone line.
- Option 4** **DTMF or Pulse Dial** - Selects DTMF or Pulse dialling. Led Off = DTMF Dial.
- Option 5** **Normal or Reverse Pulse Dial** - With this option off, the dialling pulses are normal i.e. a 1 = 1 pulse, a 9 = 9 pulses. If the option is on, then the pulses are reversed i.e. a 1 = 9 pulses, a 9 = 1 pulse.
- Option 6** **Spare**
- Option 7** **Auto-Detect Modem Format** - The panel can connect using Bell103 or V21 formats when performing upload/download connections. If this option is On the panel generates the V21 tones first and if no connection is established it then generates the Bell103 tones. If this option is turned off then the format is fixed by the selection made at option 8.
- Option 8** **Force Bell103/V21 Modem Format** - If option 7 above is turned off then the modem format to be used for upload/download is specified here. If this option is Off the format is Bell103, On is V21.

COMMUNICATOR REPORTING SCENARIOS

COMMUNICATOR REPORTING SCENARIOS

In order to provide you with the best flexibility when reporting alarms we have developed a unique system called "Reporting Scenarios". The Scenarios define what action is taken by the panel for each alarm event, e.g. alternate between numbers 1&2 until one is kissed-off or dual report to numbers 1&2 until both kissed-off. There are four individual scenarios available each with up to 16 possible steps. The Scenarios consist of a string of digits that define the reporting action to be taken by the panel. The digits in a Scenario are pre-defined. What the various digits are and their meaning are listed below.
Scenario Options;

- 1 = Call Telephone Number 1
- 2 = Call Telephone Number 2
- 3 = Call Telephone Number 3
- 4 = Call Telephone Number 4
- 5 = Call Telephone Number 5
- 6 = Call Telephone Number 6
- 7 = Return to step 1 until all numbers are kissed-off
- 8 = Return to previous step if not kissed-off
- 9 = Stop if kissed-off, if not proceed to next step

Example 1 (alternate dialling) 1 9 2 9 7

In this example we have defined a scenario with five steps as follows.

- Step 1** - Dial Ph # 1.
- Step 2** - If not Kissed-off (defined by the 9) continue to next step
- Step 3** - Dial Ph # 2
- Step 4** - If not Kissed-off (defined by the 9) continue to next step
- Step 5** - If not kissed-off return to Ph #1 (the 7 causes a return to the start)

This process is repeated until kissed-off or the maximum number of dialling attempts have been reached for this scenario.

Example 2 (dual reporting) 172 7

In this example we have defined a scenario with four steps as follows.

- Step 1** - Dial Ph # 1.
- Step 2** - If not Kissed-off return to Ph # 1 (the 7 causes a return to the start). When kissed-off or the maximum re-tries reached, move forward to the next step.
- Step 3** - Dial Ph # 2
- Step 4** - If not kissed-off return to Ph # 2 (the 7 causes a return to the start). When kissed-off or the maximum re-tries reached, move forward to the next step. If no further steps, stop.

The first step must be completed i.e. kissed-off or the maximum re-tries reached, before the panel can move past the first "7", then it can step forward and execute additional instructions up to the next 7. When the format is Contact ID or 4+2 the use of the two sevens in the scenario forces the panel to report the same signal to both numbers (Dual reporting).

REPORTING SCENARIOS

P321E - P324E

- P321E 1-16E Reporting Scenario #1 options** (See options on page 46) Default=1 7
- P322E 1-16E Reporting Scenario #2 options** (Default = 0)
- P323E 1-16E Reporting Scenario #3 options** (Default = 0)
- P324E 1-16E Reporting Scenario #4 options** (Default = 0)

Scenario #1
17

MAXIMUM DIAL ATTEMPTS PER SCENARIO NUMBER

- P325E Maximum dialling attempts for Scenario # 1-Value 1-99 (Default=10)**
- P326E Maximum dialling attempts for Scenario # 2-Value 1-99 (Default=10)**
- P327E Maximum dialling attempts for Scenario # 3-Value 1-99 (Default=10)**
- P328E Maximum dialling attempts for Scenario # 4-Value 1-99 (Default=10)**

Max Dial for Scen
3

TELEPHONE NUMBER PREFIX

- P330E 1-16E Telephone Number Prefix - 16 Characters Maximum (Pauses and special characters allowed)**

This Prefix can be added to the beginning of any of the 6 telephone numbers by turning on option 6 at addresses P343E-P348E.

Prefix Number

PROGRAM TELEPHONE NUMBERS

P331E - P336E

There are 16 characters available in each of the telephone numbers including five special characters. To program the special characters that include dialling pauses, the * and # characters, etc, refer to the table below.

- P331E 1-16E Telephone Number 1 - where options 1-16 represent up to 16 digits
- P332E 1-16E Telephone Number 2 - where options 1-16 represent up to 16 digits
- P333E 1-16E Telephone Number 3 - where options 1-16 represent up to 16 digits
- P334E 1-16E Telephone Number 4 - where options 1-16 represent up to 16 digits
- P335E 1-16E Telephone Number 5 - where options 1-16 represent up to 16 digits
- P336E 1-16E Telephone Number 6 - where options 1-16 represent up to 16 digits

Character	LED KP Button	Displayed as On 8LED KP	Displayed as On 16LED KP	Displayed as On Alert KP	LCD KP Button	Displayed as On LCD KP
2.5 sec pause	CONTROL	Control	13	Trouble	"Control" "2"	-
* Character	MEMORY	Memory	12	System	"Control" "3"	*
# Character	PANIC	Line	11	Ready	"Control" "4"	#
Wait for 2nd	ARM	Armed	14	Ready/System	"Control" "5"	W
5 sec pause	STAY	Bypass	15	Ready/Trouble	"Control" "6"	=

Phone Number 1

PROGRAMMING DIALLER OPTIONS

DEFINE REPORTING FORMATS FOR EACH TELEPHONE NUMBER - P337E - P342E

These addresses define which format the panel will use when dialling each of the six phone numbers.

P337E Reporting Format for Ph # 1 (Default= 1)

- | | |
|---|---|
| 1 = Contact ID | 8 = 4+2 10pps (Handshake 2300/ Tone 1900) |
| 2 = Domestic Dial | 9 = 4+2 20pps (Handshake 1400/ Tone 1800) |
| 3 = Pager | 10= 4+2 20pps (Handshake 1400/ Tone 1900) |
| 4 = Speech Dialler | 11= 4+2 20pps (Handshake 2300/ Tone 1800) |
| 5 = 4+2 10pps (Handshake 1400/ Tone 1800) | 12= 4+2 20pps (Handshake 2300/ Tone 1900) |
| 6 = 4+2 10pps (Handshake 1400/ Tone 1900) | 13= 4+2 DTMF |
| 7 = 4+2 10pps (Handshake 2300/ Tone 1800) | |

Phone 1 Mode
2

Option 1 **Contact ID** - Use Contact ID format to report alarm and system events to a monitoring companies receiving equipment.

Option 2 **Domestic Alarm Tone** - Use "Domestic" format to report alarm events. This format uses alternating tones to report alarms and can be kissed-off by pressing any digit in the right hand two columns on a touch tone phone. This alternating alarm tone continues for 5 seconds followed by a 5 second pause, at which time the panel is looking for a kiss-off. If a kiss-off is not received another round of alarm tones will be sent followed by another pause to check for

kiss-off. This routine is repeated 4 times, at which point if a kiss-off has not been received, the panel will hang up and dial the next phone number. Domestic dial will only report Zone activations, Manual Fire & Medical alarms, Panic alarms, Mains failure and Battery low alarms.

Option 3 Pager - Report alarm events using the Elite "Pager" format. This format sends a 12 digit numeric code to a pager. This format is restricted to reporting only the same alarm events as the Domestic Dial format above. The event report is in the form of a 12 digit message which consists of a unique 4 digit account code (NOTE: The client account number should not start with a "0"), a space character, a 3 digit event code another space character then a 3 digit identifier extension. The spaces between the account code, event code and extension make up the 12 bits of the message. There is no kiss-off required in Pager Format reporting. The account and event codes are the Contact ID codes programmed into the system. As an example, a pager which displays this message;

1 2 3 4 1 3 0 0 0 1

Would have received an alarm message from alarm 1234 (Area A account code), that there is a burglar activation 130 (contact ID burglar alarm report code), on zone 001 (zone one extension number)

Option 4 Speech Dialler - Report alarm events by using the optional add-on Voice Board. This format is similar to the Domestic Dial format in that it reports alarm events via private phone numbers and is kissed-off by pressing a button on the telephone but there is one important difference. This format will report the alarm events using pre-recorded voice messages. These messages are recorded directly into the speech module which is a "plug on" option to your Elite V6 control panel. When an alarm event is reported using the Speech Dial format the messages assigned at addresses P757E to P776E, P789E & P790E are played when the alarm occurs and like the Domestic Dial format a 5 second pause follows in which the panel is looking to be kissed-off. If not kissed-off the dialler will repeat the messages and pause again. This routine is repeated 4 times at which point, if a kiss-off has not been received the panel will hang up and dial the next phone number. To kiss-off the panel during the pause period all you do is press any of the buttons on your touch tone telephone. If a kiss-off is not received from any of the phone numbers dialled, the panel will make the maximum number of calls allowed for the scenario and shut down awaiting a new alarm trigger.

Option 5-12 4+2 Pulsed - This option sends a 4+2 signal to a monitoring station. The various options allow for 10 or 20 pulses per second and either a 1800 Hz or 1900 Hz transmit tone. There is also a selection for the initial Handshake tone from the monitoring receiver to be 1400 Hz or 2300 Hz.. Please refer to the options listed above. This format consists of sending a 4 digit account code followed by a 2 digit event code. There are many forms of 4+2 in use and the correct choice must be made in consultation with the individual monitoring stations.

Option 13 4+2 DTMF - This option sends a 4+2 DTMF (Dual Tone Multi-Frequency) signal to a monitoring station. The alarm transmission consists of a 4 digit account code, a 2 digit event code and a checksum.

The panel will automatically cease reporting in Domestic, Pager or Speech Modes if reset with a valid code. Contact ID or 4+2 modes Must be kissed off by a monitoring station receiver.

DEFINE OPTIONS FOR EACH TELEPHONE NUMBER

P343E - P348E

This group of addresses is used to define various options for each of the six phone numbers.

P343E Options for Ph # 1 (Default= 2,5)

- | | |
|---|--------------------------------------|
| 1 = Monitor Call Progress | 5 = Send Automatic Test calls |
| 2 = Blind Dial | 6 = Spare |
| 3 = Use Group Numbers for Contact ID | 7 = Spare |
| 4 = Send Restores | 8 = Spare |

Phone 1 Options

1 - - 4 5 - - -

- Option 1 Monitor Call Progress** - Monitor call progress means that the dialler monitors the status of the dialling tone to determine whether the call is valid or not. If the call is not valid, i.e. Engaged, the panel will know and hang up the call and try again.
- Option 2 Blind Dial** - When the dialler makes a call it looks for dial tone before making the call. If no dial tone is detected the panel hangs up and attempts another call. The panel will do this 3 times and if dial tone is still not detected it will make the call anyway. If blind dial is on, the panel skips the dial tone detection and dials 4 seconds after looping the line. (used where non standard or low level dial tone exists)
- Option 3 Use Separate Accounts or Group Number** - When sending an alarm using Contact ID, the panel can either send separate account codes to report the two partitions or, use one account code (Partition A) and use the group number to identify the two partitions.
- Option 4 Send Restores** - When an alarm is generated the panel automatically sends a restore when the alarm is reset. If the monitoring company does not want restores they may be turned off with this option.
- Option 5 Send Test call to Monitoring Station** - The automatic daily test call to a monitoring station can be disabled if not required by turning off this option.
- Option 6 Add Pre-fix to this Telephone Number** - The dialling Prefix at address P330E can add preset dialling parameters to all or any of the telephone numbers. This is useful if special characters are required to bypass Toll Bars or other similar restrictions that must be dialled before the telephone number. This also allows a number to be longer than the 16 characters as the Prefix is also 16 characters long.

Note: P245E through P248E are as above but applied to telephone numbers 2-6 (Default=0)

ZONE ACTIVATION SCENARIO MAPPING

P351E - P366E

These addresses are used to map activations from each of the 16 possible alarm zones to one of the 4 possible reporting scenarios. If a value of zero (0) is assigned at an address in this block, alarms from that zone will not be reported by the panel.

These addresses are used to map activations from each of the 16 possible alarm zones to one of the 4 possible reporting scenarios. If a value of zero (0) is assigned at an address in this block, alarms from that zone will not be reported by the panel.

P351E	1-4E	Zone 1 Activations mapped to Scenario 1-4 - Default 1
P352E	1-4E	Zone 2 Activations mapped to Scenario 1-4 - Default 1
P353E	1-4E	Zone 3 Activations mapped to Scenario 1-4 - Default 1
P354E	1-4E	Zone 4 Activations mapped to Scenario 1-4 - Default 1
P355E	1-4E	Zone 5 Activations mapped to Scenario 1-4 - Default 1
P356E	1-4E	Zone 6 Activations mapped to Scenario 1-4 - Default 1
P357E	1-4E	Zone 7 Activations mapped to Scenario 1-4 - Default 1
P358E	1-4E	Zone 8 Activations mapped to Scenario 1-4 - Default 1
P359E	1-4E	Zone 9 Activations mapped to Scenario 1-4 - Default 1
P360E	1-4E	Zone 10 Activations mapped to Scenario 1-4 - Default 1
P361E	1-4E	Zone 11 Activations mapped to Scenario 1-4 - Default 1
P362E	1-4E	Zone 12 Activations mapped to Scenario 1-4 - Default 1
P363E	1-4E	Zone 13 Activations mapped to Scenario 1-4 - Default 1
P364E	1-4E	Zone 14 Activations mapped to Scenario 1-4 - Default 1
P365E	1-4E	Zone 15 Activations mapped to Scenario 1-4 - Default 1
P366E	1-4E	Zone 16 Activations mapped to Scenario 1-4 - Default 1

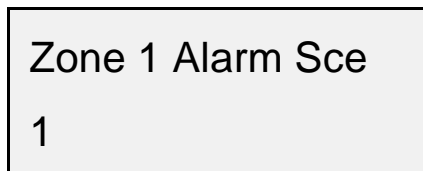

ZONE BYPASS SCENARIO MAPPING

P581E - P596E

These addresses are used to map zone bypasses (isolations) from each of the 16 possible alarm zones to one of the 4 possible reporting scenarios. If a value of zero (0) is assigned at an address in this block, bypasses from that zone will not be reported by the panel.

P581E	1-4E	Zone 1 Bypass mapped to Scenario 1-4 - Default 1
P582E	1-4E	Zone 2 Bypass mapped to Scenario 1-4 - Default 1
P583E	1-4E	Zone 3 Bypass mapped to Scenario 1-4 - Default 1

P588E 1-4E Zone 8 Bypass mapped to Scenario 1-4 - Default 1
P589E 1-4E Zone 9 Bypass mapped to Scenario 1-4 - Default 1
P590E 1-4E Zone 10 Bypass mapped to Scenario 1-4 - Default 1
P591E 1-4E Zone 11 Bypass mapped to Scenario 1-4 - Default 1
P592E 1-4E Zone 12 Bypass mapped to Scenario 1-4 - Default 1
P593E 1-4E Zone 13 Bypass mapped to Scenario 1-4 - Default 1
P594E 1-4E Zone 14 Bypass mapped to Scenario 1-4 - Default 1
P595E 1-4E Zone 15 Bypass mapped to Scenario 1-4 - Default 1
P596E 1-4E Zone 16 Bypass mapped to Scenario 1-4 - Default 1

Zone 1 bypass Sc
1

LOW ZONE TAMPERS SCENARIO MAPPING

P601E - P608E

This group of addresses is used to map the eight possible low zone tampers to one of the four possible reporting scenarios. If a value of zero (0) is assigned at an address in this block, low tampers from that zone will not be reported by the panel. Low Zone Tamper is a short circuit input.

P601E 1-4E Short Circuit Tamper Alarm on Input 1 mapped to Scenario 1-4 - Default 1
P602E 1-4E Short Circuit Tamper Alarm on Input 2 mapped to Scenario 1-4 - Default 1
P603E 1-4E Short Circuit Tamper Alarm on Input 3 mapped to Scenario 1-4 - Default 1
P604E 1-4E Short Circuit Tamper Alarm on Input 4 mapped to Scenario 1-4 - Default 1
P605E 1-4E Short Circuit Tamper Alarm on Input 5 mapped to Scenario 1-4 - Default 1
P606E 1-4E Short Circuit Tamper Alarm on Input 6 mapped to Scenario 1-4 - Default 1
P607E 1-4E Short Circuit Tamper Alarm on Input 7 mapped to Scenario 1-4 - Default 1
P608E 1-4E Short Circuit Tamper Alarm on Input 8 mapped to Scenario 1-4 - Default 1

HIGH ZONE TAMPERS SCENARIO MAPPING

P609E - P616E

This group of addresses is used to map the eight possible High zone tampers to one of the four possible reporting scenarios. If a value of zero (0) is assigned at an address in this block, high tampers from that zone will not be reported by the panel. High Zone Tamper is an open circuit input.

P609E 1-4E Open Circuit Tamper Alarm on Input 1 mapped to Scenario 1-4 - Default 1
P610E 1-4E Open Circuit Tamper Alarm on Input 2 mapped to Scenario 1-4 - Default 1
P611E 1-4E Open Circuit Tamper Alarm on Input 3 mapped to Scenario 1-4 - Default 1
P612E 1-4E Open Circuit Tamper Alarm on Input 4 mapped to Scenario 1-4 - Default 1
P613E 1-4E Open Circuit Tamper Alarm on Input 5 mapped to Scenario 1-4 - Default 1
P614E 1-4E Open Circuit Tamper Alarm on Input 6 mapped to Scenario 1-4 - Default 1
P615E 1-4E Open Circuit Tamper Alarm on Input 7 mapped to Scenario 1-4 - Default 1
P616E 1-4E Open Circuit Tamper Alarm on Input 8 mapped to Scenario 1-4 - Default 1

SYSTEM EVENTS SCENARIO MAPPING

P421E - P438E

This group of addresses is used to map System Events as listed below to one of the four possible reporting scenarios. If a value of zero (0) is assigned at an address in this block, that event will not be reported by the panel.

P421E Area A Arm/Disarm reports mapped to scenario 1-4 default 1
P422E Area B Arm/Disarm reports mapped to scenario 1-4 default 1
P423E Area C Arm/Disarm reports mapped to scenario 1-4 default 1
P424E Keypad Panic (& buttons 1 & 3) mapped to scenario 1-4 default 1
P425E Keypad Fire (buttons 4 & 6) mapped to scenario 1-4 default 1
P426E Keypad Medical (buttons 7 & 9) mapped to scenario 1-4 default 1
P427E Battery low mapped to scenario 1-4 default 1
P428E Mains fail mapped to scenario 1-4 default 1
P429E Phone line restore mapped to scenario 1-4 default 1
P430E Radio PIR battery low mapped to scenario 1-4 default 1
P431E Radio-key battery low mapped to scenario 1-4 default 1
P432E Keypad tamper mapped to scenario 1-4 default 1
P433E Cabinet tamper mapped to scenario 1-4 default 1

Area A Scenario
1

- P434E Radio panic mapped to scenario 1-4 default 1
- P435E Test calls mapped to scenario 1-4 default 1
- P436E Duress alarm mapped to scenario 1-4 default 1
- P437E Supervised radio timeout mapped to scenario 1-4 default 1
- P438E Zone inactivity timeout mapped to scenario 1-4 default 1

MULTIPLE ZONE REPORTING

P446E & P466E

- P458E 1-8E Zone will report multiple activations for zones 1-8 (Default ON)
- P478E 1-8E Zone will report multiple activations for zones 9-16 (Default ON)

PROGRAMMING TEST CALL OPTIONS

P815E - P816E

Because the PW16 runs a real time clock, it is possible to assign test calls by day of the week and time of day rather than the more common practice of spacing test calls so many hours apart.

- P815E 0-7E Test Call Days of the Week - Where 1 = Sunday and 7 = Saturday. 0 = No Test
- P816E XXXXE Test Call Time of Day - Where the time of the day you wish the panel to make its daily test call is programmed in 24 hour format.

Test Calls days

1 2 3 4 5 6 7 8

CONTACT ID AREA ACCOUNT CODES

P376E - P378E

- P376E XXXXE Account Code for Area "A" Reports - The Account code set at this address will be used to report all system events Arms and Disarms, zone activations, restores and bypasses etc from Area "A" - Default Account = 0000
- P377E XXXXE Account Code for Area "B" Reports - The account code set at this address will be used to report Arms and Disarms, zone activations, restores and bypasses etc from Area "B"
- P378E XXXXE Account Code for Area "C" Reports - The account code set at this address will be used to report Arms and Disarms, zone activations, restores and bypasses etc from Area "C"

ZONE CONTACT ID ALARM REPORTING CODE

P721E-P736E

- | | | | | |
|-------|------|--------------------|---------------|---------------|
| P721E | XXXE | Zone 1 Activation | Default = 130 | 0 = No Report |
| P722E | XXXE | Zone 2 Activation | Default = 130 | |
| P723E | XXXE | Zone 3 Activation | Default = 130 | |
| P724E | XXXE | Zone 4 Activation | Default = 130 | |
| P725E | XXXE | Zone 5 Activation | Default = 130 | |
| P726E | XXXE | Zone 6 Activation | Default = 130 | |
| P727E | XXXE | Zone 7 Activation | Default = 130 | |
| P728E | XXXE | Zone 8 Activation | Default = 130 | |
| P729E | XXXE | Zone 9 Activation | Default = 130 | |
| P730E | XXXE | Zone 10 Activation | Default = 130 | |
| P731E | XXXE | Zone 11 Activation | Default = 130 | |
| P732E | XXXE | Zone 12 Activation | Default = 130 | |
| P733E | XXXE | Zone 13 Activation | Default = 130 | |
| P734E | XXXE | Zone 14 Activation | Default = 130 | |
| P735E | XXXE | Zone 15 Activation | Default = 130 | |
| P736E | XXXE | Zone 16 Activation | Default = 130 | |

Zone 1 Code

130

MANUAL ALARM CONTACT ID REPORTING CODES

P737E-P739E

P737E	XXXE	“Panic” or “1&3” Keypad Alarm	Default = 120
P738E	XXXE	“Fire” (4&6) Keypad Alarm	Default = 110
P739E	XXXE	“Medical” (7&9) Keypad Alarm	Default = 100

ZONE TAMPER ALARM CONTACT ID REPORTING CODES

P741E-P756E

P741E	XXXE	Input 1 Short Circuit Tamper	Default = 137	0 = No Report
P742E	XXXE	Input 2 Short Circuit Tamper	Default = 137	
P743E	XXXE	Input 3 Short Circuit Tamper	Default = 137	
P744E	XXXE	Input 4 Short Circuit Tamper	Default = 137	
P745E	XXXE	Input 5 Short Circuit Tamper	Default = 137	
P746E	XXXE	Input 6 Short Circuit Tamper	Default = 137	
P747E	XXXE	Input 7 Short Circuit Tamper	Default = 137	
P748E	XXXE	Input 8 Short Circuit Tamper	Default = 137	
P749E	XXXE	Input 1 Open Circuit Tamper	Default = 137	0 = No Report
P750E	XXXE	Input 2 Open Circuit Tamper	Default = 137	
P751E	XXXE	Input 3 Open Circuit Tamper	Default = 137	
P752E	XXXE	Input 4 Open Circuit Tamper	Default = 137	
P753E	XXXE	Input 5 Open Circuit Tamper	Default = 137	
P754E	XXXE	Input 6 Open Circuit Tamper	Default = 137	
P755E	XXXE	Input 7 Open Circuit Tamper	Default = 137	
P756E	XXXE	Input 8 Open Circuit Tamper	Default = 137	

ALARM VOICE MESSAGE MAPPING

P757E - P776E, P789E, P790E

These addresses are used to assign the voice messages to the manually generated Panic, Fire, Medical, battery low and mains failure messages plus the 16 zone activation's. The voice messages will be replayed over the phone in response to an alarm activation to those phone numbers which have been assigned Speech Dial format at options P337E to P342E.

P757E	0-99E	Voice Message Mapped to Keypad “Panic” Alarm - Default 0
P758E	0-99E	Voice Message Mapped to Keypad “Fire” Alarm - Default 0
P759E	0-99E	Voice Message Mapped to Keypad “Medical” Alarm - Default 0
P761E	0-99E	Voice Message Mapped to Zone 1 Activation's - Default 1
P762E	0-99E	Voice Message Mapped to Zone 2 Activation's - Default 1
P763E	0-99E	Voice Message Mapped to Zone 3 Activation's - Default 1
P764E	0-99E	Voice Message Mapped to Zone 4 Activation's - Default 1
P765E	0-99E	Voice Message Mapped to Zone 5 Activation's - Default 1
P766E	0-99E	Voice Message Mapped to Zone 6 Activation's - Default 1
P767E	0-99E	Voice Message Mapped to Zone 7 Activation's - Default 1
P768E	0-99E	Voice Message Mapped to Zone 8 Activation's - Default 1
P769E	0-99E	Voice Message Mapped to Zone 9 Activation's - Default 1
P770E	0-99E	Voice Message Mapped to Zone 10 Activation's - Default 1
P771E	0-99E	Voice Message Mapped to Zone 11 Activation's - Default 1
P772E	0-99E	Voice Message Mapped to Zone 12 Activation's - Default 1
P773E	0-99E	Voice Message Mapped to Zone 13 Activation's - Default 1
P774E	0-99E	Voice Message Mapped to Zone 14 Activation's - Default 1
P775E	0-99E	Voice Message Mapped to Zone 15 Activation's - Default 1
P776E	0-99E	Voice Message Mapped to Zone 16 Activation's - Default 1
P789E	0-99E	Voice Message Mapped to Mains Failure Alarm - Default 0
P790E	0-99E	Voice Message Mapped to Battery Low Alarm - Default 0

Zone 1 Voice Msg 1

AREA ARM/DISARM REPORTING OPTIONS

P289E 1-8E Area "A" Reporting Options - Default 1,2

P389E 1-8E Area "B" Reporting Options - Default 1,2

P489E 1-8E Area "C" Reporting Options - Default 1,2



- 1 = Send Arm/Disarm
- 2 = Send Stay Mode Arm/Disarm
- 3 = Send Disarm only after activations
- 4 = Send Stay Disarm only after activations
- 5 = Send Arm at the end of the exit delay
- 6 = Send all zone restores when disarmed
- 7 = Spare
- 8 = Spare

- Option 1** **Send Arm / Disarm** - If this option is on, the dialler will report Area "A" arms and disarms.
- Option 2** **Send Stay Mode Arm / Disarm** - If this option is on, the dialler will report Area "A" stay mode arms and disarms.
- Option 3** **Send Disarm only after activation** - If this option is on, the dialler will report an Area A disarm following an alarm activation only. This option is often used in conjunction with alarm only reporting and stops the normal arm/disarm signals from being sent. If this option is on it will override the option 1 setting.
- Option 4** **Send Stay Mode Disarm only after activation** - If this option is on, the dialler will report an Area A Stay Mode disarm following an alarm activation only. This option is often used in conjunction with alarm only reporting and stops the normal Stay Mode arm/disarm signals from being sent. If this option is on it will override the option 2 setting.
- Option 5** **Send Arm at the end of the exit delay** - If the LED is Off, the dialler will report an Arm immediately the panel is armed. If the LED is On, the Arm report is sent at the expiry of the exit delay.
- Option 6** **Send all zone restores when disarmed** - If this option is Off, the dialler will send all zone restores as they occur. If the option is On, the dialler will send all zone restores only when the panel is disarmed. If the option is On, only one restore will be sent for each zone that activates regardless of whether the zones can send multiple alarm reports.
- Option 7** **Spare**
- Option 8** **Spare**

ENABLING VARIOUS DIALLER REPORTING OPTIONS A

- P314E 1-8E Various Reporting Options A (Default = all) On = Send, Off = Don't Send
- 1 = Report Duress via Dialler
 - 2 = Report Mains or 12V fuse (F1 & F2 on control board) Failure via Dialler
 - 3 = Report System Battery Low via Dialler
 - 4 = Report Radio Battery Low via Dialler
 - 5 = Report System Tamper via Dialler
 - 6 = Report Telephone Line Failure via Dialler
 - 7 = Report Supervised Radio alarm via Dialler
 - 8 = Report Zone Inactivity Timeout via Dialler

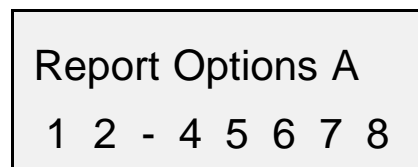

ENABLING VARIOUS DIALLER REPORTING OPTIONS B

- P315E 1-8E** Various Reporting Options B (Default = 1,2,3) On = Send, Off = Don't Send
- 1 = Report Panic Alarms via Dialler
 - 2 = Report Fire Alarms via Dialler
 - 3 = Report Medical Alarms via Dialler
 - 4 = Report 24 Hour alarms for Voice/Domestic/Pager Mode

KEYPAD LISTEN-IN OPTIONS

- P312E** Keypad Listen-in Options (Default = 1,7)
- 1 = Enabled During Dialling in Disarm State only
 - 2 = Enabled During Dialling in Armed State only
 - 3 = Enabled During Dialling in Monitor Mode State only
 - 4 = Enabled Throughout the call in Disarm State only
 - 5 = Enabled Throughout the call in Armed State only
 - 6 = Enabled Throughout the call in Monitor Mode State only
 - 7 = Listen-in Enabled when the panel answers a call
 - 8 = Enabled at All Times

OUTPUT #1 LISTEN-IN OPTIONS

- P313E** Output # 1 Listen-in Options (Default = None)
- 1 = Enabled During Dialling in Disarm State only
 - 2 = Enabled During Dialling in Armed State only
 - 3 = Enabled During Dialling in Monitor Mode State only
 - 4 = Enabled Throughout the call in Disarm State only
 - 5 = Enabled Throughout the call in Armed State only
 - 6 = Enabled Throughout the call in Monitor Mode State only
 - 7 = Listen-in Enabled when the panel answers a call
 - 8 = Enabled at All Times

AUTO-ANSWER RING COUNT

- P369E 1-99E** Auto-Answer Rings - This option defines the number of rings before the panel will auto-answer the incoming call. (Default = 25)

MAINS FAIL REPORT DELAY

- P559E 1-999E** Mains Fail Report Delay - When there is a mains supply failure, the mains must fail for longer than the programmed delay at this address before the panel will report the alarm. A value from 1-999 seconds can be programmed as the delay. A value of 0 will result in an instant report of mains failure. (Default = 600 seconds)

Zone Reporting De
0

ZONE ALARM REPORT DELAY

- P560E 0-999E** Report Delay on Zones - This delay pauses the zone reporting of alarms via the panel for the programmed period (0 = No delay or 1-999 seconds). If the alarm is reset before this delay expires no alarms will be reported.

This delay pauses the reporting of zone alarms for all reporting formats. This delay can be used to prevent false alarms from reporting if the alarm is cancelled before this delay expires.

UPLOAD/DOWNLOAD SECURITY OPTIONS

P828E **XXXXXXXX.** Up to 8 digit security code for upload/download.

P835E **Answer incoming call** - provided a user with option 5 set (P101-P150) enters in P835E while in client program mode and the telephone line is currently ringing the panel will answer the incoming call and initiate an upload/download connection.

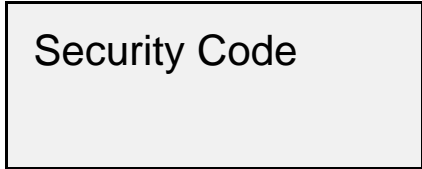

PROGRAMMING 4+2 SPECIAL CHARACTERS

When programming 4+2 event codes (see pages 76-80) you can enter in digits 1234567890 plus the following special characters BCDEF. If you enter in a value of "00" or press the "Exclude" button after a 4+2 program address then the appropriate option will not report via the dialler e.g. P865E-00-E or P865E-exclude-E will disable the keypad panic alarm reporting function in 4+2 mode. The "Control" "0" keys are used to remove an entry when using the LCD keypad. The 4+2 event codes must be 2 digits but they can be in any order e.g.;

P865E-01-E, or P865E-C6-E, or P865E-4E-E, etc.

In the above examples, the letters are programmed using the special function keys listed in the table below. When displaying the address back at the keypad the associated keypad LED's are also listed against the special letters B-F. (NOTE: A value of "0" in 4+2 will be transmitted as 10 pulses to the monitoring station).

Character	LED KP Special Function Key	Displayed as On 8LED KP	Displayed as On 16LED KP	Displayed as On Alert KP	LCD KP Special Function Key	Displayed as On LCD KP
"B"	PANIC	Line	11	Ready	"Control" "2"	B
"C"	MEMORY	Memory	12	System	"Control" "3"	C
"D"	CONTROL	Control	13	Trouble	"Control" "4"	D
"E"	ARM	Armed	14	Ready/System	"Control" "5"	E
"F"	STAY	Bypass	15	Ready/Trouble	"Control" "6"	F

COMMON CONTACT ID CODES

Medical Alarm	100	Low Temperature	159
Medical Pendant	101	High Temperature	158
Fire Alarm	110	Refrigeration Alarm	152
Smoke Detector	111	Water Leakage	154
Heat Detector	114	Gas Detector	151
Manual Call Point	115		
Duct Detector	116		
Silent Panic	122		
Audible Panic	123		
Perimeter Zone	131		
24 Hour Zone	133		
Entry Exit Zone	134		

Powerwave 16 PROGRAM SUMMARY GUIDE

The following program summary is an abbreviated version of all the Elite program addresses. This is intended as a quick guide to finding a program address. The program addresses are in numerical order with page references beside them so you can get more detailed information if required. **Because this section is in numerical order, any addresses relating to the Dialler are not necessarily grouped together. To identify Dialler options each heading relating to the Dialler are highlighted by an “***” either side of the heading.**

CLIENT MODE PROGRAMMING

Programming User Codes

P1E	User Code #1 (Master Code) if deleted code is reset to 987654 - Default 123	Page 17
P2E	User Code #2	Page 17
P3E	User Code #3	Page 17
P4E	User Code #4	Page 17
P5E	User Code #5	Page 17
P6E	User Code #6	Page 17
P7E	User Code #7	Page 17
P8E	User Code #8	Page 17
P9E	User Code #9	Page 17
P10E	User Code #10	Page 17
P11E	User Code #11	Page 17
P12E	User Code #12	Page 17
P13E	User Code #13	Page 17
P14E	User Code #14	Page 17
P15E	User Code #15	Page 17
P16E	User Code #16	Page 17
P17E	User Code #17	Page 17
P18E	User Code #18	Page 17
—		
P47E	User Code #47	Page 17
P48E	User Code #48	Page 17
P49E	User Code #49	Page 17
P50E	User Code #50	Page 17

INSTALLER PROGRAM MODE

Programming User Code Permissions

P51E	Standard Access Permissions for user #1 - Default 1-8	P51E-100E OPTIONS	Page 18
P52E	Standard Access Permissions for user #2 - Default 1-8	1 = Area "A"	Page 18
P53E	Standard Access Permissions for user #3 - Default 1-8	2 = Area "B"	Page 18
P54E	Standard Access Permissions for user #4 - Default 1-8	3 = Area "C"	Page 18
P55E	Standard Access Permissions for user #5 - Default 1-8	4 = Code can arm	Page 18
P56E	Standard Access Permissions for user #6 - Default 1-8	5 = Code can disarm	Page 18
P57E	Standard Access Permissions for user #7 - Default 1-8	6 = Code can monitor	Page 18
P58E	Standard Access Permissions for user #8 - Default 1-8	7 = Code can un-monitor	Page 18
P59E	Standard Access Permissions for user #9 - Default 1-8	8 = Code can operate Control	Page 18
P60E	Standard Access Permissions for user #10 - Default 1-8		Page 18
P61E	Standard Access Permissions for user #11 - Default 1-8		Page 18
P62E	Standard Access Permissions for user #12 - Default 1-8		Page 18
P63E	Standard Access Permissions for user #13 - Default 1-8		Page 18
P64E	Standard Access Permissions for user #14 - Default 1-8		Page 18
P65E	Standard Access Permissions for user #15 - Default 1-8		Page 18
P66E	Standard Access Permissions for user #16 - Default 1-8		Page 18
—			
P97E	Standard Access Permissions for user #47 - Default 1-8		Page 18
P98E	Standard Access Permissions for user #48 - Default 1-8		Page 18
P99E	Standard Access Permissions for user #49 - Default 1-8		Page 18
P100E	Standard Access Permissions for user #50 - Default 1-8		Page 18

Programming Extended User Code Permissions

P101E	Extended Access Permissions for user #1 - Default 1238	P101E-P150E OPTIONS	Page 18
P102E	Extended Access Permissions for user #2 - Default 0	1 = Code can override DOTL	Page 18
P103E	Extended Access Permissions for user #3 - Default 0	2 = Can change phone numbers	Page 18
P104E	Extended Access Permissions for user #4 - Default 0	3 = Can change real time clock	Page 18
P105E	Extended Access Permissions for user #5 - Default 0	4 = Can start a printout	Page 18
P106E	Extended Access Permissions for user #6 - Default 0	5 = Can answer call for u/d load	Page 18
P107E	Extended Access Permissions for user #7 - Default 0	6 = Can change their code only	Page 18
P108E	Extended Access Permissions for user #8 - Default 0	7 = Can change all codes	Page 18
P109E	Extended Access Permissions for user #9 - Default 0	8 = Allows access to installer mode via client mode.	Page 18
P110E	Extended Access Permissions for user #10 - Default 0		Page 18
P111E	Extended Access Permissions for user #11 - Default 0		Page 18
P112E	Extended Access Permissions for user #12 - Default 0		Page 18
P113E	Extended Access Permissions for user #13 - Default 0		Page 18
P114E	Extended Access Permissions for user #14 - Default 0		Page 18
P115E	Extended Access Permissions for user #15 - Default 0		Page 18
P116E	Extended Access Permissions for user #16 - Default 0		Page 18
P117E	Extended Access Permissions for user #17 - Default 0		Page 18
P118E	Extended Access Permissions for user #18 - Default 0		Page 18
—			
P1479E	Extended Access Permissions for user #47 - Default 0		Page 18
P148E	Extended Access Permissions for user #48 - Default 0		Page 18
P149E	Extended Access Permissions for user #49 - Default 0		Page 18
P150E	Extended Access Permissions for user #50 - Default 0		Page 18

Programming User Code Time Control

P151E	Access Time Zones for user #1 - Default 0 (24 Hr 7 Days)	Page 19
P152E	Access Time Zones for user #2 - Default 0 (24 Hr 7 Days)	Page 19
P153E	Access Time Zones for user #3 - Default 0 (24 Hr 7 Days)	Page 19
P154E	Access Time Zones for user #4 - Default 0 (24 Hr 7 Days)	Page 19
P156E	Access Time Zones for user #5 - Default 0 (24 Hr 7 Days)	Page 19
P157E	Access Time Zones for user #6 - Default 0 (24 Hr 7 Days)	Page 19
P158E	Access Time Zones for user #7 - Default 0 (24 Hr 7 Days)	Page 19
P159E	Access Time Zones for user #8 - Default 0 (24 Hr 7 Days)	Page 19
P160E	Access Time Zones for user #9 - Default 0 (24 Hr 7 Days)	Page 19
P161E	Access Time Zones for user #10 - Default 0 (24 Hr 7 Days)	Page 19
P162E	Access Time Zones for user #11 - Default 0 (24 Hr 7 Days)	Page 19
P163E	Access Time Zones for user #12 - Default 0 (24 Hr 7 Days)	Page 19
P164E	Access Time Zones for user #13 - Default 0 (24 Hr 7 Days)	Page 19
P165E	Access Time Zones for user #14 - Default 0 (24 Hr 7 Days)	Page 19
P166E	Access Time Zones for user #15 - Default 0 (24 Hr 7 Days)	Page 19
P167E	Access Time Zones for user #16 - Default 0 (24 Hr 7 Days)	Page 19
P168E	Access Time Zones for user #17 - Default 0 (24 Hr 7 Days)	Page 19
P169E	Access Time Zones for user #18 - Default 0 (24 Hr 7 Days)	Page 19
P170E	Access Time Zones for user #19 - Default 0 (24 Hr 7 Days)	Page 19
—		
P198E	Access Time Zones for user #48 - Default 0 (24 Hr 7 Days)	Page 19
P199E	Access Time Zones for user #49 - Default 0 (24 Hr 7 Days)	Page 19
P200E	Access Time Zones for user #50 - Default 0 (24 Hr 7 Days)	Page 19

Programming Output Options

P201E	Output #1 Primary options - Default none	1 = Invert	Page 19
P202E	Output #2 Primary options - Default none	2 = Flashing	Page 19
P203E	Output #3 Primary options - Default none	3 = Single pulse	Page 19
P204E	Output #4 Primary options - Default none	4 = One Shot (lock-out)	Page 19

P205E	Output #5 Primary options - Default none	5 = DTMF cmd remote control	Page 19
P206E	Output #6 Primary options - Default none	6 = Local command control	Page 19
P207E	Output #7 Primary options - Default none	7 = Day zone linked to pulse timer	Page 19
P208E	Output #8 Primary options - Default none	8 = Pulsed 24 Hour alarm	Page 19
P211E	Output #1 Expanded options - Default 1,3,4,5	P211E-P218E OPTIONS	Page 20
P212E	Output #2 Expanded options - Default 1,3,4,5	1 = Keypad panic to output	Page 20
P213E	Output #3 Expanded options - Default 1,3,4,5	2 = Keypad fire to output	Page 20
P214E	Output #4 Expanded options - Default 1,3,4,5	3 = Keypad medical to output	Page 20
P215E	Output #5 Expanded options - Default 1,3,4,5	4 = Duress Alarm to output	Page 20
P216E	Output #6 Expanded options - Default 1,3,4,5	5 = Keypad tamper to output	Page 20
P217E	Output #7 Expanded options - Default 1,3,4,5	6 = Radio key panic to output	Page 20
P218E	Output #8 Expanded options - Default 1,3,4,5	7 = 24 hour alarms	Page 20
		8 = 24 hour fire alarms	
P221E	Output #1 Expanded options 2 - Default 1,3,4,5	P221E-P228E OPTIONS	Page 21
P222E	Output #2 Expanded options 2 - Default 1,3,4,5	1 = Zone tampers to output	Page 21
P223E	Output #3 Expanded options 2 - Default 1,3,4,5	2 = Cabinet tamper to output	Page 21
P224E	Output #4 Expanded options 2 - Default 1,3,4,5	3 = Mains fail to output	Page 21
P225E	Output #5 Expanded options 2 - Default 1,3,4,5	4 = Battery low to output	Page 21
P226E	Output #6 Expanded options 2 - Default 1,3,4,5	5 = Phone Line failure	Page 21
P227E	Output #7 Expanded options 2 - Default 1,3,4,5	6 = Failure to get kiss-off	Page 21
P228E	Output #8 Expanded options 2 - Default 1,3,4,5	7 = Automatic pulse every 5 sec.	Page 21
		8 = 24 Hour alarm reset pulse	
P231E	Output #1 Automatic on / off time zones - Default 0 (never)		Page 21
P232E	Output #2 Automatic on / off time zones - Default 0 (never)		Page 21
P233E	Output #3 Automatic on / off time zones - Default 0 (never)		Page 21
P234E	Output #4 Automatic on / off time zones - Default 0 (never)		Page 21
P235E	Output #5 Automatic on / off time zones - Default 0 (never)		Page 21
P236E	Output #6 Automatic on / off time zones - Default 0 (never)		Page 21
P237E	Output #7 Automatic on / off time zones - Default 0 (never)		Page 21
P238E	Output #8 Automatic on / off time zones - Default 0 (never)		Page 21
P241E	Output #1 Enable time zones - Default 0 (always)		Page 22
P242E	Output #2 Enable time zones - Default 0 (always)		Page 22
P243E	Output #3 Enable time zones - Default 0 (always)		Page 22
P244E	Output #4 Enable time zones - Default 0 (always)		Page 22
P245E	Output #5 Enable time zones - Default 0 (always)		Page 22
P246E	Output #6 Enable time zones - Default 0 (always)		Page 22
P247E	Output #7 Enable time zones - Default 0 (always)		Page 22
P248E	Output #8 Enable time zones - Default 0 (always)		Page 22
P249E	Installer Code - Default 000000 - must be more than 3 digits long		Page 19

Programming Keypad Options

P250E	Keypads assigned to Area "A" - Default 1-8	Page 22
P251E	Keypads assigned to Area "B" - Default none	Page 22
P252E	Keypads assigned to Area "C" - Default none	Page 22
P253E	Keypads with permission to set - Default 1-8	Page 22
P254E	Keypads with permission to Monitor - Default 1-8	Page 22
P255E	Keypads with permission to use control function - Default 1-8	Page 23
P256E	Keypads with permission to exclude zones - Default 1-8	Page 23
P257E	Keypads (LED) with Panic Button enabled - Default 1-8	Page 23
P258E	Keypads (LED) with Delayed Panic Button enabled - Default 1-8	Page 23
P259E	Keypads with buttons 1 & 3 Panic Alarm enabled - Default None	Page 23
P260E	Keypads with buttons 4 & 6 Fire Alarm enabled - Default None	Page 23
P261E	Keypads with buttons 7 & 9 Medical Alarm enabled - Default None	Page 23
P262E	Keypads with buzzer mapped for alarm tone for armed zone alarms - Default 1-8	Page 23
P263E	Keypads with buzzer mapped for alarm tone for stay mode zone alarms - Default 1-8	Page 23
P264E	Keypads with buzzer mapped for alarm tone for 24 hour zone alarms - Default 1-8	Page 23
P265E	Keypads with buzzer mapped for alarm tone for day mode zones - Default 1-8	Page 23
P266E	Keypads with buzzer mapped to indicate Arm Mode exit delay beeps - Default 1-8	Page 23

P267E	Keypads with buzzer mapped to indicate Stay Mode exit delay beeps - Default 1-8	Page 23
P268E	Keypads with buzzer mapped to indicate entry delay beeps - Default 1-8	Page 23
P269E	Keypads with buzzer mapped for supervised radio timeout, or zone inactivity alarm - Default 0	Page 23
P270E	Keypads with buzzer mapped to keypad tamper - Default 1-8	Page 23
P271E	Keypads with buzzer mapped to zone tamper - Default 1-8	Page 23
P272E	Keypads with buzzer mapped to cabinet tamper - Default 1-8	Page 23
P273E	Keypads with buzzer mapped to Radio Pendant "Panic" Alarm - Default 1-8	Page 24
P274E	Keypads with buzzer mapped to "Panic" Alarm - Default 1-8	Page 24
P275E	Keypads with buzzer mapped to "Fire" Alarm - Default None	Page 24
P276E	Keypads with buzzer mapped to "Medical" Alarm - Default None	Page 24
P277E	Keypads with buzzer mapped to line failure - Default none	Page 24
P278E	Keypads with facility to turn off LED's after exit delay - Default none	Page 24

Partition "A" Primary Output Options

P281E	Area "A" primary options for output #1 - Default 1	P281E-P288E OPTIONS 1 = Standard zone activation's	Page 24
P282E	Area "A" primary options for output #2 - Default 1 & 3	2 = Stay Mode activation's	Page 24
P283E	Area "A" primary options for output #3 - Default 1	3 = Radio key chirps	Page 24
P284E	Area "A" primary options for output #4 - Default 1	4 = All zones sealed (ready)	Page 24
P285E	Area "A" primary options for output #5 - Default 1	5 = 2 sec pulse on arm / disarm	Page 24
P286E	Area "A" primary options for output #6 - Default 1	6 = Spare	Page 24
P287E	Area "A" primary options for output #7 - Default 1	7 = Day zone activation's	Page 24
P288E	Area "A" primary options for output #8 - Default 1	8 = Spare	Page 24

** Dialler Reporting Options for partition "A" **

P289E	Area A reporting options -Default = 1,2	Page 29
	1 = Send set / unset	5 = Send set at the end of the exit delay (LED On)
	2 = Send Stay Mode set/unset	6 = Send all zone restores at disarm only
	3 = Send unset only after activation's	7 = Spare
	4 = Send Stay Mode unset only after alarm	8 = Spare

Programming Partition "A" Parameters

P290E	Time Zones used for Area "A" auto arming /disarming- Default 0	Page 26
--------------	--	---------

Partition "A" Specific Output Options

P291E	Area "A" specific options for output #1 - Default 0	P291E-P298E OPTIONS 1 = Any exclude	Page 25
P292E	Area "A" specific options for output #2 - Default 0	2 = Auto exclude warning	Page 25
P293E	Area "A" specific options for output #3 - Default 0	3 = Entry beeps	Page 25
P294E	Area "A" specific options for output #4 - Default 0	4 = Exit beeps	Page 25
P295E	Area "A" specific options for output #5 - Default 0	5 = Control	Page 25
P296E	Area "A" specific options for output #6 - Default 0	6 = Follow Set Arming	Page 25
P297E	Area "A" specific options for output #7 - Default 0	7 = Follow Stay Arming	Page 25
P298E	Area "A" specific options for output #8 - Default 0	8 = Follow Unset	Page 25

Partition "A" Keypad Options

P299E	Arm key can disarm during exit - Default 1-8	Page 26
P300E	Stay key can disarm during Stay armed state. - Default 1-8	Page 26
P301E	Misc partition options 1 - Default = 0	Page 27
	1 = Cannot Arm if not sealed	
	2 = "Arm" required before code	
	3 = "Stay" required before code	
	4 = Code required to arm	
	5 = Code required for control	
	6 = Control toggles	
	7 = Momentary control	
	8 = Control/Chime disables day zones	

Partition "A" Misc Options

- P302E** Misc partition options 2 - Default 3,4,6 Page 28
- 1 = Key-switch enabled
 - 2 = Use 2nd Key-switch
 - 3 = Key-switch ARM's/STAY
 - 4 = Pendant chirps when Armed
 - 5 = Pendant chirps when in Stay Mode
 - 6 = 2 sec pulse at set
 - 7 = 2 sec pulse at unset
 - 8 = Access control even when armed
- P303E PARTITION "A" TIME AND DELAY OPTIONS-Default = 0** Page 26
- 1 = Set partition When Time Zone Ends
 - 2 = Unset Partition When Time Zone Starts
 - 3 = Disable Stay Mode Exit Delay
 - 4 = Disable Set Mode Exit Delay
 - 5 = Disable Stay Mode Entry Delay
 - 6 = Disable Set Mode Entry Delay
 - 7 = Use special Stay Mode entry timer
 - 8 = Report Stay Mode alarms & Bypasses via dialler

Miscellaneous System Options "A"

- P310E** Options - Default 3,4,5,7 Page 30
- 1 = Ignore Mains fail
 - 2 = Siren Output on O/P # 1
 - 3 = Siren Output on O/P # 2
 - 4 = Turn Off Alert KP LED's when armed
 - 5 = Ignore Zone Tamper's during exit delay
 - 6 = Installer code direct access
 - 7 = Installer lockout
 - 8 = Area "C" is zones shared with Area A & B

Miscellaneous System Options "B"

- P311E** Options - Default Page 30
- 1 = System Tamper EOL or short circuit loop
 - 2 = Key-switch Tamper EOL or short circuit loop
 - 3 = Low Key-switch is momentary or latching
 - 4 = High Key-switch is momentary or latching
 - 5 =
 - 6 =
 - 7 =
 - 8 =

Keypad Listen-in Options

- P312E** Keypad Listen-in Options Page 57
- P312E Options (Default = 1-7 On)**
- 1 = Enabled During Dialling in Disarm State only
 - 2 = Enabled During Dialling in Armed State only
 - 3 = Enabled During Dialling in Monitor Mode State only
 - 4 = Enabled Throughout the call in Disarm State only
 - 5 = Enabled Throughout the call in Armed State only
 - 6 = Enabled Throughout the call in Monitor Mode State only
 - 7 = Listen-in Enabled when the panel answers a call
 - 8 = Enabled at All Times

Output #1 Listen-in Options

- P313E** Output # 1 Listen-in Options Page 57
- P313E Options (Default = Off)**
- 1 = Enabled During Dialling in Disarm State only
 - 2 = Enabled During Dialling in Armed State only
 - 3 = Enabled During Dialling in Monitor Mode State only
 - 4 = Enabled Throughout the call in Disarm State only
 - 5 = Enabled Throughout the call in Armed State only

6 = Enabled Throughout the call in Monitor Mode State only

7 = Listen-in Enabled when the panel answers a call

8 = Enabled at All Times

** Miscellaneous Dialler Reporting Options A **

P314E	Dialler Misc Report Options A	P314E Options (Default = 1,2,3,4,5,6,7,8)	Page 56
		1 = Report Duress via Dialler	
		2 = Report Mains Failure via Dialler	
		3 = Report System Battery Low via Dialler	
		4 = Report Radio Battery Low via Dialler	
		5 = Report System Tamper via Dialler	
		6 = Report Telephone Line Failure via Dialler	
		7 = Report Supervised Radio Timeout via Dialler	
		8 = Report Zone Inactivity Timeout via Dialler	

** Miscellaneous Dialler Reporting Options B **

P315E	Dialler Misc Report Options B	P315E Options (Default = 1,2,3)	Page 57
		1 = Report Panic Alarms via Dialler	
		2 = Report Fire Alarms via Dialler	
		3 = Report Medical Alarms via Dialler	
		4 = Report 24 Hour alarms in Domestic/Pager/Voice Mode.	

** Reporting Scenarios **

P321E	Reporting Scenario #1 options (Default = 1,7)	Page 49
P322E	Reporting Scenario #2 options (Default = 0)	Page 49
P323E	Reporting Scenario #3 options (Default = 0)	Page 49
P324E	Reporting Scenario #4 options (Default = 0)	Page 49

** Maximum Dialling Attempts per Scenario **

P325E	Max Dial Attempts for Scenario Number 1-Value 1-99 (Default=10)	Page 49
P326E	Max Dial Attempts for Scenario Number 2-Value 1-99 (Default=10)	Page 49
P327E	Max Dial Attempts for Scenario Number 3-Value 1-99 (Default=10)	Page 49
P328E	Max Dial Attempts for Scenario Number 4-Value 1-99 (Default=10)	Page 49

** Telephone Numbers Pre-fix **

P330E	Telephone Number Pre-fix 16 Character Maximum	Page 49
--------------	---	---------

** Programming Telephone Numbers **

P331E	Telephone Number 1 16 Character Maximum	Page 50
P332E	Telephone Number 2 16 Character Maximum	Page 50
P333E	Telephone Number 3 16 Character Maximum	Page 50
P334E	Telephone Number 4 16 Character Maximum	Page 50
P335E	Telephone Number 5 16 Character Maximum	Page 50
P336E	Telephone Number 6 16 Character Maximum	Page 50

** Telephone Number Reporting Options **

P337E	Reporting Opts. Ph # 1 (Default= 1)	P337E-P342E Options	Page 50
P338E	Reporting Opts. Ph # 2 (Default= None)	1 = Contact ID	
P339E	Reporting Opts. Ph # 3 (Default= None)	2 = Domestic Dial	
P340E	Reporting Opts. Ph # 4 (Default= None)	3 = Pager	
P341E	Reporting Opts. Ph # 5 (Default= None)	4 = Speech Dialler	
P342E	Reporting Opts. Ph # 6 (Default= None)	5 = 4+2 10pps (Handshake 1400/ Tone 1800)	
		6 = 4+2 10pps (Handshake 1400/ Tone 1900)	
		7 = 4+2 10pps (Handshake 2300/ Tone 1800)	
		8 = 4+2 10pps (Handshake 2300/ Tone 1900)	
		9 = 4+2 20pps (Handshake 1400/ Tone 1800)	
		10= 4+2 20pps (Handshake 1400/ Tone 1900)	
		11= 4+2 20pps (Handshake 2300/ Tone 1800)	
		12= 4+2 20pps (Handshake 2300/ Tone 1900)	
		13= 4+2 DTMF	

Telephone Number Reporting Options

P343E	Options for Telephone # 1	P343E-P348E Options (Default =2,5,6) 1 = Monitor Call Progress 2 = Blind Dial 3 = Use Group Numbers for Contact ID 4 = Send Restores 5 = Send Test Calls 6 = Spare 7 = Spare 8 = Spare	Page 51
P344E	Options for Telephone # 2		
P345E	Options for Telephone # 3		
P346E	Options for Telephone # 4		
P347E	Options for Telephone # 5		
P348E	Options for Telephone # 6		

Programming Duress Digit

P350E	Duress Digit (Value can be 1-9, 0 = disabled) default 0	Page 31
--------------	---	---------

** Zone Activation to Scenario Mapping **

P351E	Zone 1 activation's mapped to scenario 1-4 default 1	Page 52
P352E	Zone 2 activation's mapped to scenario 1-4 default 1	Page 52
P353E	Zone 3 activation's mapped to scenario 1-4 default 1	Page 52
P354E	Zone 4 activation's mapped to scenario 1-4 default 1	Page 52
P355E	Zone 5 activation's mapped to scenario 1-4 default 1	Page 52
P356E	Zone 6 activation's mapped to scenario 1-4 default 1	Page 52
P357E	Zone 7 activation's mapped to scenario 1-4 default 1	Page 52
P358E	Zone 8 activation's mapped to scenario 1-4 default 1	Page 52
P359E	Zone 9 activation's mapped to scenario 1-4 default 1	Page 52
P360E	Zone 10 activation's mapped to scenario 1-4 default 1	Page 52
P361E	Zone 11 activation's mapped to scenario 1-4 default 1	Page 52
P362E	Zone 12 activation's mapped to scenario 1-4 default 1	Page 52
P363E	Zone 13 activation's mapped to scenario 1-4 default 1	Page 52
P364E	Zone 14 activation's mapped to scenario 1-4 default 1	Page 52
P365E	Zone 15 activation's mapped to scenario 1-4 default 1	Page 52
P366E	Zone 16 activation's mapped to scenario 1-4 default 1	Page 52

** Auto Answer Ring Count **

P369E	Auto-answer ring count - default = 25	Page 57
--------------	---------------------------------------	---------

** System reporting Options **

P370E	System options (Default = 7)	Page 48
	1 = Enable communicator	5 = Reverse Style Pulse
	2 = Fax defeat	6 = Spare
	3 = Disable line monitoring	7 = Auto-Detect Modem Format
	4 =DTMF or Pulse	8 = Force Bell103/V21

** Command Control Options **

P371E	Command code for output control	Page 45
P372E	Command code for Area "A" control	Page 45
P373E	Command code for Area "B" control	Page 45
P374E	Command code for Area "C" control	Page 45
P375E	Command code to turn "MICROPHONE" On	Page 45

** Contact ID Account Codes **

P376E	Account number for Area "A" - default 0000	Page 54
P377E	Account number for Area "B"	Page 54
P378E	Account number for Area "C"	Page 54

Partition "B" Primary Output Options

P381E	Area "B" primary options for output #1 - Default 1	P381E-P388E OPTIONS	1 = Standard zone activation's	Page 24
P382E	Area "B" primary options for output #2 - Default 1 & 3		2 = Stay Mode activation's	Page 24
P383E	Area "B" primary options for output #3 - Default 1		3 = Radio key chirps	Page 24
P384E	Area "B" primary options for output #4 - Default 1		4 = All zones sealed (Ready)	Page 24
P385E	Area "B" primary options for output #5 - Default 1		5 = 2 sec pulse arm/disarm	Page 24
P386E	Area "B" primary options for output #6 - Default 1		6 = Spare	Page 24
P387E	Area "B" primary options for output #7 - Default 1		7 = Day zone activation's	Page 24
P388E	Area "B" primary options for output #8 - Default 1		8 = Spare	Page 24

** Dialler Reporting Options for partition "B" **

P389E	Area B reporting options -Default = 1,2	Page 30
	1 = Send set / unset	5 = Send set at the end of the exit delay (LED On)
	2 = Send Stay Mode set/unset	6 = Send all zone restores at disarm only
	3 = Send unset only after activation's	7 = Spare
	4 = Send Stay Mode unset only after alarm	8 = Spare

Programming Partition "B" Parameters

P390E	Time zones used for Area "B" auto arming/disarming - Default 0	Page 26
--------------	--	---------

Partition "B" Specific Output Options

P391E	Area "B" specific options for output #1 - Default 0	P391E-P398E OPTIONS	1 =Any exclude	Page 25
P392E	Area "B" specific options for output #2 - Default 0		2 = Auto exclude warning	Page 25
P393E	Area "B" specific options for output #3 - Default 0		3 = Entry beeps	Page 25
P394E	Area "B" specific options for output #4 - Default 0		4 = Exit beeps	Page 25
P395E	Area "B" specific options for output #5 - Default 0		5 = Control	Page 25
P396E	Area "B" specific options for output #6 - Default 0		6 = Follow Set Arming	Page 25
P397E	Area "B" specific options for output #7 - Default 0		7 = Follow Stay Arming	Page 25
P398E	Area "B" specific options for output #8 - Default 0		8 = Follow Unset	Page 25

Partition "B" Keypad Options

P399E	Arm key can disarm during exit - Default 1-8	Page 26
P400E	Stay key can disarm during Stay armed state - Default 1-8	Page 26

Partition "B" Misc Options

P401E	Misc partition options 1 - Default 0	1 = Cannot Arm if not sealed	Page 27
		2 = "Arm" required before code	
		3 = "Stay" required before code	
		4 = Code required to arm	
		5 = Code required for control	
		6 = Control toggles	
		7 = Momentary control	
		8 = Control/Chime disables day zones	
P402E	Misc partitions options 2 - Default 3,4,6	1 = Key-switch enabled	Page 28
		2 = Use 2nd Key-switch	
		3 = Key-switch ARM's/STAY	
		4 = Pendant chirps when armed	
		5 = Pendant chirps when in Stay Mode	
		6 = 2 sec pulse at set	
		7 = 2 sec pulse at unset	
		8 = Access control even when armed	

P445E	Stay mode zones - Default zones 1-4	Page 33
P446E	Zone is isolatable - Default all	Page 33
P447E	Auto exclude zones - Default all	Page 33
P448E	Zone is a handover - Default none	Page 33
P449E	Two trigger zones -Default none	Page 33
P450E	Zone is 24Hr - Default none	Page 33
P451E	Zone is 24Hr Fire zone - Default none	Page 33
P452E	Zone is 24Hr Non-Latching zone - Default none	Page 33
P453E	Day zones - Default none	Page 33
P454E	Continuous day zone - Default none	Page 34
P455E	Siren lockout zones - Default none	Page 34
P456E	Access control door position input - Default none	Page 34
P457E	Access control request to exit input - Default none	Page 34

* * Multiple Zone Activation Reporting * *

P458E	Zones 1-8 will report multiple activation's - default on	Page 34
Zones 1-8 Monitored for Inactivity		
P459E	Zones 1-8 will be monitored for inactivity - default none	Page 34

Cannot Arm if Zone is Unsealed-Zones 1-8

P460E	Cannot Arm if Zone Unsealed-Zones 1-8 - default none	Page 34
--------------	--	---------

High Zone Assignments (Zones 9-16)

P461E	Zone is in Area "A" - Default all	Page 34
P462E	Zone is in Area "B" - Default none If zone is in both it is then a partition "C" zone	Page 34
P463E	Zone is a normally open/closed output - Default N/C off = N/C On = N/O	Page 34
P464E	Zone is a radio detector - Default off	Page 35
P465E	Stay mode zones - Default zones none	Page 35
P466E	Zone is isolatable - Default all	Page 35
P467E	Auto exclude zones - Default all	Page 35
P468E	Zone is a handover - Default none	Page 35
P469E	Two trigger zones -Default none	Page 35
P470E	Zone is 24Hr - Default none	Page 35
P471E	Zone is 24Hr Fire zone - Default none	Page 35
P472E	Zone is 24Hr Non-Latching zone - Default none	Page 35
P473E	Day zones - Default none	Page 35
P474E	Continuous day zone - Default none	Page 35
P475E	Siren lockout zones - Default none	Page 35
P476E	Access control door position input - Default none	Page 36
P477E	Access control request to exit input - Default none	Page 36

* * Multiple Zone Activation Reporting * *

P478E	Zones 9-16 will report multiple activation's - default on	Page 36
Zones 9-16 Monitored for Inactivity		
P479E	Zones 9-16 will be monitored for inactivity - default none	Page 36

Cannot Arm if Zone is Unsealed-Zones 9-16

P480E	Cannot Arm if Zone Unsealed-Zones 9-16 - default none	Page 36
--------------	---	---------

Partition "C" Primary Output Options

P481E-P488E OPTIONS		
P481E	Area "C" primary options for output #1- Default 1	1 = Standard zone activation's Page 24
P482E	Area "C" primary options for output #2 - Default 1 & 3	2 = Stay Mode activation's Page 24
P483E	Area "C" primary options for output #3 - Default 1	3 = Radio key chirps Page 24
P484E	Area "C" primary options for output #4 - Default 1	4 = All zones sealed (ready) Page 24
P485E	Area "C" primary options for output #5 - Default 1	5 = 2 sec pulse on arm/disarm Page 24
P486E	Area "C" primary options for output #6 - Default 1	6 = Spare Page 24
P487E	Area "C" primary options for output #7 - Default 1	7 = Day zone activation's Page 24
P488E	Area "C" primary options for output #8 - Default 1	8 = Spare Page 24

* * Dialler Reporting Options for partition "C" * *

P489E	Area C reporting options -Default = 1,2	Page 30
--------------	---	---------

- 1 = Send set / unset
- 2 = Send Stay Mode set/unset
- 3 = Send unset only after activation's
- 4 = Send Stay Mode unset only after alarm
- 5 = Send set at the end of the exit delay (LED On)
- 6 = Send all zone restores at disarm only
- 7 = Spare
- 8 = Spare

Programming Partition "C" Parameters

P490E Time zones used for Area "C" auto-arming/disarming - Default 0 Page 26

Partition "C" Specific Output Options

- P491E** Area "C" specific options for output #1 - Default 0
- P492E** Area "C" specific options for output #2 - Default 0
- P493E** Area "C" specific options for output #3 - Default 0
- P494E** Area "C" specific options for output #4 - Default 0
- P495E** Area "C" specific options for output #5 - Default 0
- P496E** Area "C" specific options for output #6 - Default 0
- P497E** Area "C" specific options for output #7 - Default 0
- P498E** Area "C" specific options for output #8 - Default 0

P491E-P498E OPTIONS

- 1 = Any exclude Page 25
- 2 = Auto exclude warn Page 25
- 3 = Entry beeps Page 25
- 4 = Exit Beeps Page 25
- 5 = Control Page 25
- 6 = Follow Set Arming Page 25
- 7 = Follow Stay Arming Page 25
- 8 = Follow Unset Page 25

Partition "C" Keypad Options

P499E Arm key can disarm during exit - Default 1-8 Page 26

P500E Stay key can disarm during Stay armed state - Default 1-8 Page 26

Partition "C" Misc Options

P501E Misc partition options 1 - Default 0

- 1 = Cannot Arm if not sealed Page 27
- 2 = "Arm" required before code
- 3 = "Stay" required before code
- 4 = Code required to arm
- 5 = Code required for control
- 6 = Control toggles
- 7 = Momentary control
- 8 = Control disables day zones

P502E Misc partition options 2 - Default 3,4,6

- 1 = Key-switch enabled Page 28
- 2 = Use 2nd Key-switch
- 3 = Key-switch ARM's/STAY
- 4 = Pendant chirps when armed
- 5 = Pendant chirps when in Stay Mode
- 6 = 2 sec pulse at set
- 7 = 2 sec pulse at unset
- 8 = Access control even when armed

P503E PARTITION "C" TIME AND DELAY OPTIONS (Default 0) Page 26

- 1 = set partition When Time Zone Ends
- 2 = Unset Partition When Time Zone Starts
- 3 = Disable Stay Mode Exit Delay
- 4 = Disable Set Mode Exit Delay
- 5 = Disable Stay Mode Entry Delay
- 6 = Disable Set Mode Entry Delay
- 7 = Use special Stay Mode entry timer
- 8 = Report Stay Mode alarms & Bypasses via dialler

System Delays & Timers

- P511E** Zone 1 entry delay - Default 20 sec
- P512E** Zone 2 entry delay - Default 20 sec
- P513E** Zone 3 entry delay - Default 0
- P514E** Zone 4 entry delay - Default 0
- P515E** Zone 5 entry delay - Default 0

- Delay timer values Page 36
- 0 = instant, no delay Page 36
- 1-9999 = 1 -9999 seconds Page 36
- Page 36
- Page 36

P516E	Zone 6 entry delay - Default 0		Page 36
P517E	Zone 7 entry delay - Default 0		Page 36
P518E	Zone 8 entry delay - Default 0		Page 36
P519E	Zone 9 entry delay - Default 0		Page 36
P520E	Zone 10 entry delay - Default 0		Page 36
P521E	Zone 11 entry delay - Default 0		Page 36
P522E	Zone 12 entry delay - Default 0		Page 36
P523E	Zone 13 entry delay - Default 0		Page 36
P524E	Zone 14 entry delay - Default 0		Page 36
P525E	Zone 15 entry delay - Default 0		Page 36
P526E	Zone 16 entry delay - Default 0		Page 36
P531E	Area "A" exit delay - Default = 60 sec		Page 36
P532E	Area "B" exit delay - Default = 60 sec		Page 36
P533E	Area "C" exit delay - Default = 60 sec		Page 36
P534E	Area "A" two trigger time period - Default 60 sec		Page 36
P535E	Area "B" two trigger time period - Default 60 sec		Page 36
P536E	Area "C" two trigger time period - Default 60 sec		Page 36
P537E	Area "A" door open too long timer (DOTL) - Default 10 sec		Page 38
P538E	Area "B" door open too long timer (DOTL) - Default 10 sec		Page 38
P539E	Area "C" door open too long timer (DOTL) - Default 10 sec		Page 38
P540E	Area "A" Special Stay Mode entry delay - Default 20 sec		Page 36
P541E	Area "B" Special Stay Mode entry delay - Default 20 sec		Page 36
P542E	Area "C" Special Stay Mode entry delay - Default 20 sec		Page 36
P543E	Area "A" day zone keypad buzzer duration - Default 2 sec		Page 37
P544E	Area "B" day zone keypad buzzer duration - Default 2 sec		Page 37
P545E	Area "C" day zone keypad buzzer duration - Default 2 sec		Page 37
P546E	Area "A" day zone to Output duration - Default 2 sec		Page 37
P547E	Area "B" day zone to Output duration - Default 2 sec		Page 37
P548E	Area "C" day zone to Output duration - Default 2 sec		Page 37
P551E	Output #1 reset time - Default 600 sec	Reset time values	Page 37
P552E	Output #2 reset time - Default 600 sec	0 = latching	Page 37
P553E	Output #3 reset time - Default 600 sec	1-999 = 1 to 999 seconds	Page 37
P554E	Output #4 reset time - Default 600 sec		Page 37
P555E	Output #5 reset time - Default 0 sec		Page 37
P556E	Output #6 reset time - Default 0 sec		Page 37
P557E	Output #7 reset time - Default 0 sec		Page 37
P558E	Output #8 reset time - Default 0 sec		Page 37
P559E	Mains Fail Reporting Delay to Dialer (0-9999 sec) - Default = 600		Page 37
P560E	Zone Reporting Delay to Dialer (0-9999 sec) - Default = 0		Page 37
P561E	Output #1 delay on timer - Default 0	Delay time values	Page 37
P562E	Output #2 delay on timer - Default 0	0 = no delay	Page 37
P563E	Output #3 delay on timer - Default 0	1 - 999 = 1 to 999 seconds	Page 37
P564E	Output #4 delay on timer - Default 0		Page 37
P565E	Output #4 delay on timer - Default 0		Page 37
P566E	Output #5 delay on timer - Default 0		Page 37
P567E	Output #6 delay on timer - Default 0		Page 37
P568E	Output #7 delay on timer - Default 0		Page 37
P569E	Zone Inactivity Timer (0-255 hour) - Default = 120 Hours		Page 37
P570E	Supervised Radio Timer (0-255 minutes) - Default = 240 Minutes		Page 37
P571E	Output #1 pulse time - Default 1	Pulse time values	Page 37
P572E	Output #2 pulse time - Default 1	1-999 (min of 1)	Page 37

P573E	Output #3 pulse time - Default 1	1 to 999 in 1/10 secs	Page 37
P574E	Output #4 pulse time - Default 1	e.g. 1 = 0.1 second	Page 37
P575E	Output #5 pulse time - Default 1	10 = 1 second	Page 37
P576E	Output #6 pulse time - Default 1		Page 37
P577E	Output #7 pulse time - Default 1		Page 37
P578E	Output #8 pulse time - Default 1		Page 37

** Bypass to Scenario Mapping **

P581E	Zone 1 bypass mapped to scenario 1-4	default 1	Page 52
P582E	Zone 2 bypass mapped to scenario 1-4	default 1	Page 52
P583E	Zone 3 bypass mapped to scenario 1-4	default 1	Page 52
P584E	Zone 4 bypass mapped to scenario 1-4	default 1	Page 53
P585E	Zone 5 bypass mapped to scenario 1-4	default 1	Page 53
P586E	Zone 6 bypass mapped to scenario 1-4	default 1	Page 53
P587E	Zone 7 bypass mapped to scenario 1-4	default 1	Page 53
P588E	Zone 8 bypass mapped to scenario 1-4	default 1	Page 53
P589E	Zone 9 bypass mapped to scenario 1-4	default 1	Page 53
P590E	Zone 10 bypass mapped to scenario 1-4	default 1	Page 53
P591E	Zone 11 bypass mapped to scenario 1-4	default 1	Page 53
P592E	Zone 12 bypass mapped to scenario 1-4	default 1	Page 53
P593E	Zone 13 bypass mapped to scenario 1-4	default 1	Page 53
P594E	Zone 14 bypass mapped to scenario 1-4	default 1	Page 53
P595E	Zone 15 bypass mapped to scenario 1-4	default 1	Page 53
P596E	Zone 16 bypass mapped to scenario 1-4	default 1	Page 53

** Low Zone Tamperers to Scenario Mapping **

P601E	Low zone 1 tamper alarms mapped to scenario 1-4	default 1	Page 53
P602E	Low zone 2 tamper alarms mapped to scenario 1-4	default 1	Page 53
P603E	Low zone 3 tamper alarms mapped to scenario 1-4	default 1	Page 53
P604E	Low zone 4 tamper alarms mapped to scenario 1-4	default 1	Page 53
P605E	Low zone 5 tamper alarms mapped to scenario 1-4	default 1	Page 53
P606E	Low zone 6 tamper alarms mapped to scenario 1-4	default 1	Page 53
P607E	Low zone 7 tamper alarms mapped to scenario 1-4	default 1	Page 53
P608E	Low zone 8 tamper alarms mapped to scenario 1-4	default 1	Page 53

** High Zone Tamperers to Scenario Mapping **

P609E	High zone 1 tamper alarms mapped to scenario 1-4	default 1	Page 53
P610E	High zone 2 tamper alarms mapped to scenario 1-4	default 1	Page 53
P611E	High zone 3 tamper alarms mapped to scenario 1-4	default 1	Page 53
P612E	High zone 4 tamper alarms mapped to scenario 1-4	default 1	Page 53
P613E	High zone 5 tamper alarms mapped to scenario 1-4	default 1	Page 53
P614E	High zone 6 tamper alarms mapped to scenario 1-4	default 1	Page 53
P615E	High zone 7 tamper alarms mapped to scenario 1-4	default 1	Page 53
P616E	High zone 8 tamper alarms mapped to scenario 1-4	default 1	Page 53

Enrolling Radio Detectors (Zones 1-16)-see also P344E & P364E

P620E 1-16E	Enrol Radio Detector Zones 1-16	Page 38
--------------------	---------------------------------	---------

Radio Zone Detector Options

P621E	Options for Zone # 1 (Default= 0)	P601E-P616E Options	Page 38
P622E	Options for Zone # 2 (Default= 0)	1 = Crow AE Series Battery low	Page 38
P623E	Options for Zone # 3 (Default= 0)	2 = Crow AE Radio Reed Switch	Page 38
P624E	Options for Zone # 4 (Default= 0)	3 = Crow Merlin PIR (Non-supervised)	Page 38
P625E	Options for Zone # 5 (Default= 0)	4 = Crow Merlin PIR (supervised signal active)	Page 38
		5 = Crow Merlin/checksum (supervise active)	Page 38
		6 = Crow Merlin/checksum (supervise ignored)	Page 38
P626E	Options for Zone # 6 (Default= 0)	11 = Ness Devices battery Low	Page 38
P627E	Options for Zone # 7 (Default= 0)	12 = Ness Radio Reed Switch	Page 38

P628E	Options for Zone # 8 (Default= 0)	21 = Electronics Line Radio PIR	Page 38
P629E	Options for Zone # 9 (Default= 0)	31 = Visonic K900 Radio PIR	Page 38
P630E	Options for Zone # 10 (Default= 0)		Page 38
P631E	Options for Zone # 11 (Default= 0)		
P632E	Options for Zone # 12 (Default= 0)		
P633E	Options for Zone # 13 (Default= 0)		
P634E	Options for Zone # 14 (Default= 0)		
P635E	Options for Zone # 15 (Default= 0)		
P636E	Options for Zone # 16 (Default= 0)		

Enrolling Radio Keys

P640E 1-20E	Enrol Radio Users 1-20		Page 39
--------------------	------------------------	--	---------

Radio Key Type

P641E	Radio user #1 Type - Default 0	0 = non-specific	Page 40
P642E	Radio user #2 Type - Default 0	1 = Crow	Page 40
P643E	Radio user #3 Type - Default 0	21 = Ness	Page 40
P644E	Radio user #4 Type - Default 0	31 = Visonic	Page 40
P645E	Radio user #5 Type - Default 0		Page 40
P646E	Radio user #6 Type - Default 0		Page 40
P647E	Radio user #7 Type - Default 0		Page 40
P648E	Radio user #8 Type - Default 0		Page 40
P649E	Radio user #9 Type - Default 0		Page 40
P650E	Radio user #10 Type - Default 0		Page 40
P651E	Radio user #11 Type - Default 0		Page 40
P652E	Radio user #12 Type - Default 0		Page 40
P653E	Radio user #13 Type - Default 0		Page 40
P654E	Radio user #14 Type - Default 0		Page 40
P655E	Radio user #15 Type - Default 0		Page 40
P656E	Radio user #16 Type - Default 0		Page 40
P657E	Radio user #17 Type - Default 0		Page 40
P658E	Radio user #18 Type - Default 0		Page 40
P659E	Radio user #19 Type - Default 0		Page 40
P660E	Radio user #20 Type - Default 0		Page 40

Radio Key Options 1st Set

P661E	Radio user #1 options - Default 1,4,5	P661E - 680E OPTIONS	
P662E	Radio user #2 options - Default 1,4,5	1 = Area "A" permission	Page 39
P663E	Radio user #3 options - Default 1,4,5	2 = Area "B" permission	Page 39
P664E	Radio user #4 options - Default 1,4,5	3 = Area "C" permission	Page 39
P665E	Radio user #5 options - Default 1,4,5	4 = User can arm	Page 39
P666E	Radio user #6 options - Default 1,4,5	5 = User can disarm	Page 39
P667E	Radio user #7 options - Default 1,4,5	6 = User can Arm Stay Mode	Page 39
P668E	Radio user #8 options - Default 1,4,5	7 = User can Disarm Stay Mode	Page 39
P669E	Radio user #9 options - Default 1,4,5	8 = User disabled if in alarm	Page 39
P670E	Radio user #10 options - Default 1,4,5		Page 39
P671E	Radio user #11 options - Default 1,4,5		Page 39
P672E	Radio user #12 options - Default 1,4,5		Page 39
P673E	Radio user #13 options - Default 1,4,5		Page 39
P674E	Radio user #14 options - Default 1,4,5		Page 39
P675E	Radio user #15 options - Default 1,4,5		Page 39
P676E	Radio user #16 options - Default 1,4,5		Page 39
P677E	Radio user #17 options - Default 1,4,5		Page 39
P678E	Radio user #18 options - Default 1,4,5		Page 39
P679E	Radio user #19 options - Default 1,4,5		Page 39
P680E	Radio user #20 options - Default 1,4,5		Page 39

Radio Key Options 2nd Set

P681E	Radio user #1 options - Default 0	P681E-P700E OPTIONS	Page 40
P682E	Radio user #2 options - Default 0	1 = User turns control on	Page 40
P683E	Radio user #3 options - Default 0	2 = User turns control off	Page 40
P684E	Radio user #4 options - Default 0	3 = User turns output on	Page 40
P685E	Radio user #5 options - Default 0	4 = User turns output off	Page 40
P686E	Radio user #6 options - Default 0		Page 40
P687E	Radio user #7 options - Default 0	5 = User causes immediate panic	Page 40
P688E	Radio user #8 options - Default 0	6 = User causes delayed panic	Page 40
P689E	Radio user #9 options - Default 0	7 = Spare	Page 40
P690E	Radio user #10 options - Default 0	8 = Spare	Page 40
P691E	Radio user #11 options - Default 0		Page 40
P692E	Radio user #12 options - Default 0		Page 40
P693E	Radio user #13 options - Default 0		Page 40
P694E	Radio user #14 options - Default 0		Page 40
P695E	Radio user #15 options - Default 0		Page 40
P696E	Radio user #16 options - Default 0		Page 40
P697E	Radio user #17 options - Default 0		Page 40
P698E	Radio user #18 options - Default 0		Page 40
P699E	Radio user #19 options - Default 0		Page 40
P700E	Radio user #20 options - Default 0		Page 40

Mapping Radio Users to Outputs

P701E	Radio user #1 to output 1-8 - Default = 0	Page 41
P702E	Radio user #2 to output 1-8 - Default = 0	Page 41
P703E	Radio user #3 to output 1-8 - Default = 0	Page 41
P704E	Radio user #4 to output 1-8 - Default = 0	Page 41
P705E	Radio user #5 to output 1-8 - Default = 0	Page 41
P706E	Radio user #6 to output 1-8 - Default = 0	Page 41
P707E	Radio user #7 to output 1-8 - Default = 0	Page 41
P708E	Radio user #8 to output 1-8 - Default = 0	Page 41
P709E	Radio user #9 to output 1-8 - Default = 0	Page 41
P710E	Radio user #10 to output 1-8 - Default = 0	Page 41
P711E	Radio user #11 to output 1-8 - Default = 0	Page 41
P712E	Radio user #12 to output 1-8 - Default = 0	Page 41
P713E	Radio user #13 to output 1-8 - Default = 0	Page 41
P714E	Radio user #14 to output 1-8 - Default = 0	Page 41
P715E	Radio user #15 to output 1-8 - Default = 0	Page 41
P716E	Radio user #16 to output 1-8 - Default = 0	Page 41
P717E	Radio user #17 to output 1-8 - Default = 0	Page 41
P718E	Radio user #18 to output 1-8 - Default = 0	Page 41
P719E	Radio user #19 to output 1-8 - Default = 0	Page 41
P720E	Radio user #20 to output 1-8 - Default = 0	Page 41

** Contact ID Zone Alarm Code Assignments **

P721E	Zone 1 activation - default = 130	Page 54
P722E	Zone 2 activation - default = 130	Page 54
P723E	Zone 3 activation - default = 130	Page 54
P724E	Zone 4 activation - default = 130	Page 54
P725E	Zone 5 activation - default = 130	Page 54
P726E	Zone 6 activation - default = 130	Page 54
P727E	Zone 7 activation - default = 130	Page 54
P728E	Zone 8 activation - default = 130	Page 54
P729E	Zone 9 activation - default = 130	Page 54
P730E	Zone 10 activation - default = 130	Page 54
P731E	Zone 11 activation - default = 130	Page 54
P732E	Zone 12 activation - default = 130	Page 54
P733E	Zone 13 activation - default = 130	Page 54
P734E	Zone 14 activation - default = 130	Page 54
P735E	Zone 15 activation - default = 130	Page 54
P736E	Zone 16 activation - default = 130	Page 54

Keypad Panic Alarm Contact I D Reporting Code

P737E Keypad Panic Alarm (& button 1 & 3) Contact ID Code (Default=120) Page 55

Keypad Fire Alarm Contact I D Reporting Code

P738E Keypad Fire Alarm (button 4 & 6) Contact ID Code (Default=110) Page 55

Keypad Medical Alarm Contact I D Reporting Code

P739E Keypad Medical Alarm (button 7 & 9) Contact ID Code (Default=100) Page 55

** Contact I D Zone Tamper Code Assignments **

P741E Zone 1 Tamper activation - default = 137 Page 55

P742E Zone 2 Tamper activation - default = 137 Page 55

P743E Zone 3 Tamper activation - default = 137 Page 55

P744E Zone 4 Tamper activation - default = 137 Page 55

P745E Zone 5 Tamper activation - default = 137 Page 55

P746E Zone 6 Tamper activation - default = 137 Page 55

P747E Zone 7 Tamper activation - default = 137 Page 55

P748E Zone 8 Tamper activation - default = 137 Page 55

P749E Zone 9 Tamper activation - default = 137 Page 55

P750E Zone 10 Tamper activation - default = 137 Page 55

P751E Zone 11 Tamper activation - default = 137 Page 55

P752E Zone 12 Tamper activation - default = 137 Page 55

P753E Zone 13 Tamper activation - default = 137 Page 55

P754E Zone 14 Tamper activation - default = 137 Page 55

P755E Zone 15 Tamper activation - default = 137 Page 55

P756E Zone 16 Tamper activation - default = 137 Page 55

*Keypad Panic Alarm Voice Message Mapping**

P757E Voice message number mapped to panic alarm - default 1 Page 55

Keypad Fire Alarm Voice Message Mapping

P758E Voice message number mapped to Fire (4&6) alarm - default 1 Page 55

Keypad Medical Alarm Voice Message Mapping

P759E Voice message number mapped to Medical (7&9) alarm - default 1 Page 55

Zone Alarm Voice Message Mapping

P761E Voice message number mapped to zone 1 activation - default 1 Page 55

P762E Voice message number mapped to zone 2 activation - default 1 Page 55

P763E Voice message number mapped to zone 3 activation - default 1 Page 55

P764E Voice message number mapped to zone 4 activation - default 1 Page 55

P765E Voice message number mapped to zone 5 activation - default 1 Page 55

P766E Voice message number mapped to zone 6 activation - default 1 Page 55

P767E Voice message number mapped to zone 7 activation - default 1 Page 55

P768E Voice message number mapped to zone 8 activation - default 1 Page 55

P769E Voice message number mapped to zone 9 activation - default 1 Page 55

P770E Voice message number mapped to zone 10 activation - default 1 Page 55

P771E Voice message number mapped to zone 11 activation - default 1 Page 55

P772E Voice message number mapped to zone 12 activation - default 1 Page 55

P773E Voice message number mapped to zone 13 activation - default 1 Page 55

P774E Voice message number mapped to zone 14 activation - default 1 Page 55

P775E Voice message number mapped to zone 15 activation - default 1 Page 55

P776E Voice message number mapped to zone 16 activation - default 1 Page 55

Arm/Disarm Command Control Status Message Addressing

P777E Start of Status Message for Area "A" Command Control - Default 0 Page 45

P778E Start of Status Message for Area "B" Command Control - Default 0 Page 45

P779E Start of Status Message for Area "C" Command Control - Default 0 Page 45

Output Command Control Status Message Addressing

P781E Start of Status Message for Output #1 Command Control - Default 0 Page 46

P782E Start of Status Message for Output #2 Command Control - Default 0 Page 46

P783E	Start of Status Message for Output #3 Command Control - Default 0	Page 46
P784E	Start of Status Message for Output #4 Command Control - Default 0	Page 46
P785E	Start of Status Message for Output #5 Command Control - Default 0	Page 46
P786E	Start of Status Message for Output #6 Command Control - Default 0	Page 46
P787E	Start of Status Message for Output #7 Command Control - Default 0	Page 46
P788E	Start of Status Message for Output #8 Command Control - Default 0	Page 46

* * Mains & Battery Voice Message Mapping * *

P789E	Voice message number mapped to Mains Failure - default 0	Page 55
P790E	Voice message number mapped to Battery Low - default 0	Page 55

Defining Time Zones

P791E	Time Zone 1 day of the week Default 0	TIME ZONE PROGRAMMING	Page 41
P792E	Time Zone 1 start time - Default 0	DAYS 1 - 7	Page 41
P793E	Time Zone 1 finish time - Default 0	1 = Sunday	Page 41
P794E	Time Zone 2 day of the week - Default 0	2 = Monday	Page 41
P795E	Time Zone 2 start time - Default 0	3 = Tuesday	Page 41
P796E	Time Zone 2 finish time - Default 0	4 = Wednesday	Page 41
P797E	Time Zone 3 day of the week - Default 0	5 = Thursday	Page 41
P798E	Time Zone 3 start time - Default 0	6 = Friday	Page 41
P799E	Time Zone 3 finish time - Default 0	7 = Saturday	Page 41
P800E	Time Zone 4 day of the week - Default 0	8 = Invert time zone	Page 41
P801E	Time Zone 4 start time - Default 0	Times = 0000-2359	Page 41
P802E	Time Zone 4 finish time - Default 0		Page 41
P803E	Time Zone 5 day of the week - Default 0		Page 41
P804E	Time Zone 5 start time - Default 0		Page 41
P805E	Time Zone 5 finish time - Default 0		Page 41
P806E	Time Zone 6 day of the week - Default 0		Page 41
P807E	Time Zone 6 start time - Default 0		Page 41
P808E	Time Zone 6 finish time - Default 0		Page 41
P809E	Time Zone 7 day of the week - Default 0		Page 41
P810E	Time Zone 7 start time - Default 0		Page 41
P811E	Time Zone 7 finish time - Default 0		Page 41
P812E	Time Zone 8 day of the week - Default 0		Page 41
P813E	Time Zone 8 start time - Default 0		Page 42
P814E	Time Zone 8 finish time - Default 0		Page 42

* * Test Calls * *

P815E	Test calls for days of the week 1-7	Page 54
P816E	Test call time of the day	Page 54

Programming Daylight saving Adjustments

P817E	Daylight saving start Sunday - Default 1	Page 42
P818E	Daylight saving start month - Default 10	Page 42
P819E	Daylight saving start hour - Default 2	Page 42
P820E	Daylight saving end Sunday - Default 3	Page 42
P821E	Daylight saving end month - Default 3	Page 42
P822E	Daylight saving end hour - Default 3	Page 42

Setting the Real Time Clock

P823E	Set day of the week (1 -7 where 1 = Sunday)	Page 43
P824E	Set time (HHMM)	Page 43
P825E	Set day of the month (1 - 31)	Page 43
P826E	Set month (1 - 12)	Page 43
P827E	Set year	Page 43

**** Upload/Download Security Code ****

P828E XXXXXXXX. Up to 8 digit security code Page 58

Dynamic Data

P830E Misc system flags Page 42
1 = Spare 5=Spare
2 = Spare 6=Spare
3 = Spare 7=Spare
4 = Spare 8=Daylight saving active

P831E Display keyboard address Page 42

P832E Display partitions assigned to this keypad (1=A, 2=B, 3=C) Page 42

P833E Display software version Page 42

Printing Events

P834E Start event printing Page 44

**** Manually Answering an In-coming Call ****

P835E Answer incoming call (user initiated) Page 58

Walk Test Mode

P836E Toggle walk-test mode ON/OFF Page 44

Temporary Output Disable Mode

P837E Temporary Output Disable mode - Outputs 1-8 Page 43

EE² Upload/Download

P838E Write to EE² board on serial port. Page 43

P839E Copy from EE² board on serial port to panel. Page 43

Reset to Defaults

P840E Reset user codes Page 44

P841E Reset communicator parameters Page 44

P842E Reset radio parameters Page 44

P843E Reset PA & Voice Board Parameters Page 44

P844E Reset All other Parameters Page 44

P845E Reset Everything back to factory Default Page 44

Clear Output Parameters

P846E Clear all output parameters (outputs 1 - 8) Page 44

Clear Memory Events

P847E Clear the 255 event Memory Buffer Page 44

P848E Clear unreported PA events Page 44

Active Time Zones

P849E Active Time-Zones Page 42

PA Board Output ON Message

P851E PA Board Output #1 On Message - Default 0

P852E PA Board Output #2 On Message - Default 0

P853E PA Board Output #3 On Message - Default 0

P854E PA Board Output #4 On Message - Default 0

P855E PA Board Output #5 On Message - Default 0

P856E PA Board Output #6 On Message - Default 0

P857E PA Board Output #7 On Message - Default 0

P858E PA Board Output #8 On Message - Default 0

PA Board Output OFF Message

P861E PA Board Output #1 Off Message - Default 0

P862E PA Board Output #2 Off Message - Default 0

P863E PA Board Output #3 Off Message - Default 0

P864E PA Board Output #4 Off Message - Default 0

P865E PA Board Output #5 Off Message - Default 0
P866E PA Board Output #6 Off Message - Default 0
P867E PA Board Output #7 Off Message - Default 0
P868E PA Board Output #8 Off Message - Default 0

PA Board Entry Delay Message

P871E PA Board Area "A" Entry Delay Message - Default 0
P872E PA Board Area "B" Entry Delay Message - Default 0
P873E PA Board Area "C" Entry Delay Message - Default 0

PA Board Exit Delay Message

P874E PA Board Area "A" Exit Delay Message - Default 0
P875E PA Board Area "B" Exit Delay Message - Default 0
P876E PA Board Area "C" Exit Delay Message - Default 0

PA Board Armed Message

P877E PA Board Area "A" Armed Message - Default 0
P878E PA Board Area "B" Armed Message - Default 0
P879E PA Board Area "C" Armed Message - Default 0

PA Board Monitor Mode Armed Message

P881E PA Board Area "A" Monitor Mode Armed Message - Default 0
P882E PA Board Area "B" Monitor Mode Armed Message - Default 0
P883E PA Board Area "C" Monitor Mode Armed Message - Default 0

PA Board Disarmed Message

P884E PA Board Area "A" Disarmed Message - Default 0
P885E PA Board Area "B" Disarmed Message - Default 0
P886E PA Board Area "C" Disarmed Message - Default 0

PA Board Door Open Too Long (DOTL) Message

P887E PA Board Area "A" DOTL Message - Default 0
P888E PA Board Area "B" DOTL Message - Default 0
P889E PA Board Area "C" DOTL Message - Default 0

** PA Board Zone Alarm Message **

P891E Zone 1 Alarm PA Board Message default 0
P892E Zone 2 Alarm PA Board Message default 0
P893E Zone 3 Alarm PA Board Message default 0
P894E Zone 4 Alarm PA Board Message default 0
P895E Zone 5 Alarm PA Board Message default 0
P896E Zone 6 Alarm PA Board Message default 0
P897E Zone 7 Alarm PA Board Message default 0
P898E Zone 8 Alarm PA Board Message default 0
P899E Zone 9 Alarm PA Board Message default 0
P900E Zone 10 Alarm PA Board Message default 0
P901E Zone 11 Alarm PA Board Message default 0
P902E Zone 12 Alarm PA Board Message default 0
P903E Zone 13 Alarm PA Board Message default 0
P904E Zone 14 Alarm PA Board Message default 0
P905E Zone 15 Alarm PA Board Message default 0
P906E Zone 16 Alarm PA Board Message default 0

** Miscellaneous PA Board Alarm Message **

P907E Mains Failure PA Board Message default 0
P908E Battery Low PA Board Message default 0
P909E System Tamper Alarm PA Board Message default 0
P910E Zone Tamper Alarm PA Board Message default 0
P911E Radio Pendant Panic Alarm PA Board Message default 0
P912E Keypad Panic Alarm PA Board Message default 0

P913E	Keypad Fire Alarm PA Board Message default 0	
P914E	Keypad Medical Alarm PA Board Message default 0	
	System Tamper 4+2 Reporting Code	
P921E	4+2 Alarm Code for System Tamper (Default=86)	Page 58
	System Tamper Restore 4+2 Reporting Code	
P922E	4+2 Alarm Code for System Tamper Restore (Default=87)	Page 58
	Armed by "Arm" Button 4+2 Reporting Code	
P923E	4+2 Arm by "Arm" Button or Key-switch Code (Default=81)	Page 58
	Single button or key-switch disarm 4+2 Reporting Code	
P924E	4+2 Disarm by Arm or Monitor Button or Key-switch (Default=83)	Page 58
	Monitor Mode Arming 4+2 Reporting Code	
P925E	4+2 Monitor Mode Arming Code (Default=82)	Page 58
	Low Battery 4+2 Reporting Codes	
P926E	Low Battery 4+2 Code (Default=94)	Page 58
P927E	Low Battery Restore 4+2 Code (Default=96)	Page 58
	Mains Failure 4+2 Restore Codes	
P928E	Mains Failure 4+2 Code (Default=95)	Page 58
P929E	Mains Failure restore 4+2 Code (Default=97)	Page 58
	Panic Alarm 4+2 Restore Codes	
P930E	Manual Panic Alarm 4+2 Code (Default=88)	Page 58
P931E	Manual Panic Alarm Restore 4+2 Code (Default=91)	Page 58
	Fire Alarm 4+2 Restore Codes	
P932E	Manual Fire Alarm 4+2 Code (Default=89)	Page 58
P933E	Manual Medical Alarm Restore 4+2 Code (Default=93)	Page 58
	Medical Alarm 4+2 Restore Codes	
P934E	Manual Medical Alarm 4+2 Code (Default=90)	Page 58
P935E	Manual Medical Alarm Restore 4+2 Code (Default=93)	Page 58
	Duress Alarm 4+2 Reporting Code	
P936E	4+2 Duress Alarm Code (Default=84)	Page 58
	Automatic Test 4+2 Reporting Code	
P937E	4+2 Automatic Test Code (Default=85)	Page 58
	Zone Alarm 4+2 Reporting Code	
P941E	4+2 Alarm Code for Zone 1 (Default=01)	Page 58
P942E	4+2 Alarm Code for Zone 2 (Default=02)	Page 58
P943E	4+2 Alarm Code for Zone 3 (Default=03)	Page 58
P944E	4+2 Alarm Code for Zone 4 (Default=04)	Page 58
P945E	4+2 Alarm Code for Zone 5 (Default=05)	Page 58
P946E	4+2 Alarm Code for Zone 6 (Default=06)	Page 58
P947E	4+2 Alarm Code for Zone 7 (Default=07)	Page 58
P948E	4+2 Alarm Code for Zone 8 (Default=08)	Page 58
P949E	4+2 Alarm Code for Zone 9 (Default=09)	Page 58
P950E	4+2 Alarm Code for Zone 10 (Default=01)	Page 58
P958E	4+2 Alarm Code for Zone 11 (Default=02)	Page 58
P952E	4+2 Alarm Code for Zone 12 (Default=03)	Page 58
P953E	4+2 Alarm Code for Zone 13 (Default=04)	Page 58
P954E	4+2 Alarm Code for Zone 14 (Default=05)	Page 58
P955E	4+2 Alarm Code for Zone 15 (Default=06)	Page 58
P956E	4+2 Alarm Code for Zone 16 (Default=07)	Page 58

** Zone Alarm Restore 4+2 Reporting Code **

P961E	4+2 Alarm Restore Code for Zone 1 (Default=11)	Page 58
P962E	4+2 Alarm Restore Code for Zone 2 (Default=12)	Page 58
P963E	4+2 Alarm Restore Code for Zone 3 (Default=13)	Page 58
P964E	4+2 Alarm Restore Code for Zone 4 (Default=14)	Page 58
P965E	4+2 Alarm Restore Code for Zone 5 (Default=15)	Page 58
P966E	4+2 Alarm Restore Code for Zone 6 (Default=16)	Page 58
P967E	4+2 Alarm Restore Code for Zone 7 (Default=17)	Page 58
P968E	4+2 Alarm Restore Code for Zone 8 (Default=18)	Page 58
P969E	4+2 Alarm Restore Code for Zone 9 (Default=19)	Page 58
P970E	4+2 Alarm Restore Code for Zone 10 (Default=11)	Page 58
P971E	4+2 Alarm Restore Code for Zone 11 (Default=12)	Page 58
P972E	4+2 Alarm Restore Code for Zone 12 (Default=13)	Page 58
P973E	4+2 Alarm Restore Code for Zone 13 (Default=14)	Page 58
P974E	4+2 Alarm Restore Code for Zone 14 (Default=15)	Page 58
P975E	4+2 Alarm Restore Code for Zone 15 (Default=16)	Page 58
P976E	4+2 Alarm Restore Code for Zone 16 (Default=17)	Page 58

** Zone Bypassed 4+2 Reporting Code **

P981E	4+2 Bypass Message for Zone 1 (Default=21)	Page 58
P982E	4+2 Bypass Message for Zone 2 (Default=22)	Page 58
P983E	4+2 Bypass Message for Zone 3 (Default=23)	Page 58
P984E	4+2 Bypass Message for Zone 4 (Default=24)	Page 58
P985E	4+2 Bypass Message for Zone 5 (Default=25)	Page 58
P986E	4+2 Bypass Message for Zone 6 (Default=26)	Page 58
P987E	4+2 Bypass Message for Zone 7 (Default=27)	Page 58
P988E	4+2 Bypass Message for Zone 8 (Default=28)	Page 58
P989E	4+2 Bypass Message for Zone 9 (Default=29)	Page 58
P990E	4+2 Bypass Message for Zone 10 (Default=30)	Page 58
P991E	4+2 Bypass Message for Zone 11 (Default=21)	Page 58
P992E	4+2 Bypass Message for Zone 12 (Default=22)	Page 58
P993E	4+2 Bypass Message for Zone 13 (Default=23)	Page 58
P994E	4+2 Bypass Message for Zone 14 (Default=24)	Page 58
P995E	4+2 Bypass Message for Zone 15 (Default=25)	Page 58
P996E	4+2 Bypass Message for Zone 16 (Default=26)	Page 58

** Zone Bypassed 4+2 Restore Code **

P1001E	4+2 Bypass Restore Message for Zone 1 (Default=31)	Page 58
P1002E	4+2 Bypass Restore Message for Zone 2 (Default=32)	Page 58
P1003E	4+2 Bypass Restore Message for Zone 3 (Default=33)	Page 58
P1004E	4+2 Bypass Restore Message for Zone 4 (Default=34)	Page 58
P1005E	4+2 Bypass Restore Message for Zone 5 (Default=35)	Page 58
P1006E	4+2 Bypass Restore Message for Zone 6 (Default=36)	Page 58
P1007E	4+2 Bypass Restore Message for Zone 7 (Default=37)	Page 58
P1008E	4+2 Bypass Restore Message for Zone 8 (Default=38)	Page 58
P1009E	4+2 Bypass Restore Message for Zone 9 (Default=39)	Page 58
P1010E	4+2 Bypass Restore Message for Zone 10 (Default=40)	Page 58
P1011E	4+2 Bypass Restore Message for Zone 11 (Default=31)	Page 58
P1012E	4+2 Bypass Restore Message for Zone 12 (Default=32)	Page 58
P1013E	4+2 Bypass Restore Message for Zone 13 (Default=33)	Page 58
P1014E	4+2 Bypass Restore Message for Zone 14 (Default=34)	Page 58
P1015E	4+2 Bypass Restore Message for Zone 15 (Default=35)	Page 58
P1016E	4+2 Bypass Restore Message for Zone 16 (Default=36)	Page 58

** Armed by User # 4+2 Reporting Code **

P1021E	4+2 Arm Code for User 1 (Default=41)	Page 58
P1022E	4+2 Arm Code for User 2 (Default=42)	Page 58
P1023E	4+2 Arm Code for User 3 (Default=43)	Page 58
P1024E	4+2 Arm Code for User 4 (Default=44)	Page 58
P1025E	4+2 Arm Code for User 5 (Default=45)	Page 58
P1026E	4+2 Arm Code for User 6 (Default=46)	Page 58
P1027E	4+2 Arm Code for User 7 (Default=47)	Page 58

P1028E	4+2 Arm Code for User 8 (Default=48)	Page 58
P1029E	4+2 Arm Code for User 9 (Default=49)	Page 58
P1030E	4+2 Arm Code for User 10 (Default=50)	Page 58
P1031E	4+2 Arm Code for User 11 (Default=41)	Page 58
P1032E	4+2 Arm Code for User 12 (Default=42)	Page 58
P1033E	4+2 Arm Code for User 13 (Default=43)	Page 58
P1034E	4+2 Arm Code for User 14 (Default=44)	Page 58
P1035E	4+2 Arm Code for User 15 (Default=45)	Page 58
P1036E	4+2 Arm Code for User 16 (Default=46)	Page 58
P1037E	4+2 Arm Code for User 17 (Default=47)	Page 58
P1038E	4+2 Arm Code for User 18 (Default=48)	Page 58
P1039E	4+2 Arm Code for User 19 (Default=49)	Page 58
P1040E	4+2 Arm Code for User 20 (Default=50)	Page 58
P1041E	4+2 Arm Code for User 21 (Default=41)	Page 58
P1042E	4+2 Arm Code for User 22 (Default=42)	Page 58
P1043E	4+2 Arm Code for User 23 (Default=43)	Page 58
P1044E	4+2 Arm Code for User 24 (Default=44)	Page 58
P1045E	4+2 Arm Code for User 25 (Default=45)	Page 58
P1046E	4+2 Arm Code for User 26 (Default=46)	Page 58
P1047E	4+2 Arm Code for User 27 (Default=47)	Page 58
P1048E	4+2 Arm Code for User 28 (Default=48)	Page 58
P1049E	4+2 Arm Code for User 29 (Default=49)	Page 58
P1050E	4+2 Arm Code for User 30 (Default=50)	Page 58
P1058E	4+2 Arm Code for User 31 (Default=41)	Page 58
P1052E	4+2 Arm Code for User 32 (Default=42)	Page 58
P1053E	4+2 Arm Code for User 33 (Default=43)	Page 58
P1054E	4+2 Arm Code for User 34 (Default=44)	Page 58
P1056E	4+2 Arm Code for User 35 (Default=45)	Page 58
P1057E	4+2 Arm Code for User 36 (Default=46)	Page 58
P1057E	4+2 Arm Code for User 37 (Default=47)	Page 58
P1058E	4+2 Arm Code for User 38 (Default=48)	Page 58
P1059E	4+2 Arm Code for User 39 (Default=49)	Page 58
P1060E	4+2 Arm Code for User 40 (Default=50)	Page 58
P1061E	4+2 Arm Code for User 41 (Default=41)	Page 58
P1062E	4+2 Arm Code for User 42 (Default=42)	Page 58
P1063E	4+2 Arm Code for User 43 (Default=43)	Page 58
P1064E	4+2 Arm Code for User 44 (Default=44)	Page 58
P1066E	4+2 Arm Code for User 45 (Default=46)	Page 58
P1067E	4+2 Arm Code for User 46 (Default=47)	Page 58
P1067E	4+2 Arm Code for User 47 (Default=47)	Page 58
P1068E	4+2 Arm Code for User 48 (Default=48)	Page 58
P1069E	4+2 Arm Code for User 49 (Default=49)	Page 58
P1070E	4+2 Arm Code for User 50 (Default=50)	Page 58

* * Disarmed by User # 4+2 Reporting Code * *

P1071E	4+2 Disarm Code for User 1 (Default=51)	Page 58
P1072E	4+2 Disarm Code for User 2 (Default=52)	Page 58
P1073E	4+2 Disarm Code for User 3 (Default=53)	Page 58
P1074E	4+2 Disarm Code for User 4 (Default=54)	Page 58
P1075E	4+2 Disarm Code for User 5 (Default=55)	Page 58
P1076E	4+2 Disarm Code for User 6 (Default=56)	Page 58
P1077E	4+2 Disarm Code for User 7 (Default=57)	Page 58
P1078E	4+2 Disarm Code for User 8 (Default=58)	Page 58
P1079E	4+2 Disarm Code for User 9 (Default=59)	Page 58
P1080E	4+2 Disarm Code for User 10 (Default=60)	Page 58
P1081E	4+2 Disarm Code for User 11 (Default=58)	Page 58
P1082E	4+2 Disarm Code for User 12 (Default=52)	Page 58
P1083E	4+2 Disarm Code for User 13 (Default=53)	Page 58
P1084E	4+2 Disarm Code for User 14 (Default=54)	Page 58
P1085E	4+2 Disarm Code for User 15 (Default=55)	Page 58
P1086E	4+2 Disarm Code for User 16 (Default=56)	Page 58
P1087E	4+2 Disarm Code for User 17 (Default=57)	Page 58
P1088E	4+2 Disarm Code for User 18 (Default=58)	Page 58

P1089E	4+2 Disarm Code for User 19 (Default=59)	Page 58
P1090E	4+2 Disarm Code for User 20 (Default=60)	Page 58
P1091E	4+2 Disarm Code for User 21 (Default=51)	Page 58
P1092E	4+2 Disarm Code for User 22 (Default=52)	Page 58
P1093E	4+2 Disarm Code for User 23 (Default=53)	Page 58
P1094E	4+2 Disarm Code for User 24 (Default=54)	Page 58
P1095E	4+2 Disarm Code for User 25 (Default=55)	Page 58
P1096E	4+2 Disarm Code for User 26 (Default=56)	Page 58
P1097E	4+2 Disarm Code for User 27 (Default=57)	Page 58
P1098E	4+2 Disarm Code for User 28 (Default=58)	Page 58
P1099E	4+2 Disarm Code for User 29 (Default=59)	Page 58
P1100E	4+2 Disarm Code for User 30 (Default=60)	Page 58
P1101E	4+2 Disarm Code for User 31 (Default=58)	Page 58
P1102E	4+2 Disarm Code for User 32 (Default=52)	Page 58
P1103E	4+2 Disarm Code for User 33 (Default=53)	Page 58
P1104E	4+2 Disarm Code for User 34 (Default=54)	Page 58
P1105E	4+2 Disarm Code for User 35 (Default=55)	Page 58
P1106E	4+2 Disarm Code for User 36 (Default=56)	Page 58
P1107E	4+2 Disarm Code for User 37 (Default=57)	Page 58
P1108E	4+2 Disarm Code for User 38 (Default=58)	Page 58
P1109E	4+2 Disarm Code for User 39 (Default=59)	Page 58
P1110E	4+2 Disarm Code for User 40 (Default=60)	Page 58
P1111E	4+2 Disarm Code for User 41 (Default=51)	Page 58
P1112E	4+2 Disarm Code for User 42 (Default=52)	Page 58
P1113E	4+2 Disarm Code for User 43 (Default=53)	Page 58
P1114E	4+2 Disarm Code for User 44 (Default=54)	Page 58
P1115E	4+2 Disarm Code for User 45 (Default=55)	Page 58
P1116E	4+2 Disarm Code for User 46 (Default=56)	Page 58
P1117E	4+2 Disarm Code for User 47 (Default=57)	Page 58
P1118E	4+2 Disarm Code for User 48 (Default=58)	Page 58
P1119E	4+2 Disarm Code for User 49 (Default=59)	Page 58
P1120E	4+2 Disarm Code for User 50 (Default=60)	Page 58

**** Armed by Radio Pendant User # 4+2 Reporting Code ****

P1121E	4+2 Arm Code for Radio User 1 (Default=61)	Page 58
P1122E	4+2 Arm Code for Radio User 2 (Default=62)	Page 58
P1123E	4+2 Arm Code for Radio User 3 (Default=63)	Page 58
P1124E	4+2 Arm Code for Radio User 4 (Default=64)	Page 58
P1125E	4+2 Arm Code for Radio User 5 (Default=65)	Page 58
P1126E	4+2 Arm Code for Radio User 6 (Default=66)	Page 58
P1127E	4+2 Arm Code for Radio User 7 (Default=67)	Page 58
P1128E	4+2 Arm Code for Radio User 8 (Default=68)	Page 58
P1129E	4+2 Arm Code for Radio User 9 (Default=69)	Page 58
P1130E	4+2 Arm Code for Radio User 10 (Default=70)	Page 58
P1131E	4+2 Arm Code for Radio User 11 (Default=61)	Page 58
P1132E	4+2 Arm Code for Radio User 12 (Default=62)	Page 58
P1133E	4+2 Arm Code for Radio User 13 (Default=63)	Page 58
P1134E	4+2 Arm Code for Radio User 14 (Default=64)	Page 58
P1135E	4+2 Arm Code for Radio User 15 (Default=65)	Page 58
P1136E	4+2 Arm Code for Radio User 16 (Default=66)	Page 58
P1137E	4+2 Arm Code for Radio User 17 (Default=67)	Page 58
P1138E	4+2 Arm Code for Radio User 18 (Default=68)	Page 58
P1139E	4+2 Arm Code for Radio User 19 (Default=69)	Page 58
P1140E	4+2 Arm Code for Radio User 20 (Default=70)	Page 58

**** Disarmed by Radio Pendant User # 4+2 Reporting Code ****

P1141E	4+2 Disarm Code for Radio User 1 (Default=71)	Page 58
P1142E	4+2 Disarm Code for Radio User 2 (Default=72)	Page 58
P1143E	4+2 Disarm Code for Radio User 3 (Default=73)	Page 58
P1144E	4+2 Disarm Code for Radio User 4 (Default=74)	Page 58
P1145E	4+2 Disarm Code for Radio User 5 (Default=75)	Page 58
P1146E	4+2 Disarm Code for Radio User 6 (Default=76)	Page 58
P1147E	4+2 Disarm Code for Radio User 7 (Default=77)	Page 58

P1148E	4+2 Disarm Code for Radio User 8 (Default=78)	Page 58
P1149E	4+2 Disarm Code for Radio User 9 (Default=79)	Page 58
P1150E	4+2 Disarm Code for Radio User 10 (Default=80)	Page 58
P1151E	4+2 Disarm Code for Radio User 11 (Default=71)	Page 58
P1152E	4+2 Disarm Code for Radio User 12 (Default=72)	Page 58
P1153E	4+2 Disarm Code for Radio User 13 (Default=73)	Page 58
P1154E	4+2 Disarm Code for Radio User 14 (Default=74)	Page 58
P1155E	4+2 Disarm Code for Radio User 15 (Default=75)	Page 58
P1156E	4+2 Disarm Code for Radio User 16 (Default=76)	Page 58
P1157E	4+2 Disarm Code for Radio User 17 (Default=77)	Page 58
P1158E	4+2 Disarm Code for Radio User 18 (Default=78)	Page 58
P1159E	4+2 Disarm Code for Radio User 19 (Default=79)	Page 58
P1160E	4+2 Disarm Code for Radio User 20 (Default=80)	Page 58

COMMUNICATOR INTRODUCTION

The communicator facility of this version 6 Elite controller has been designed to provide optimum flexibility in the way in which alarm events are reported. This flexibility includes options for reporting to a central monitoring station using Contact ID format, a domestic reporting option using alternating siren tones, a format for reporting alarms to an alpha numeric pager and a powerful speech dialler.

In accordance with the statutory requirements of the Telepermit standards we must bring the following points to your attention;

A readily accessible disconnect device shall be incorporated into the 230V fixed wiring.

In the event of any problem with this device, the by-pass switch should be operated. The user is to then arrange with the installer of the device to make the necessary repairs. Should the matter be reported to Telecom as a wiring fault, and the fault be proven to be due to the alarm panel, a call out charge will be incurred.

Should the Elite control panel require relocation the Telecom connection must be disconnected before the power is disconnected. Similarly when reconnecting the dialler, it is necessary to power up the Elite before connecting the dialler to the Telecom Network.

Connection to the Telecom network should be made in accordance with Access Standards Newsletter #65 dated November 1993. This connection is to be readily accessible to allow disconnection in the event of a fault. An example of this connection method is shown below.

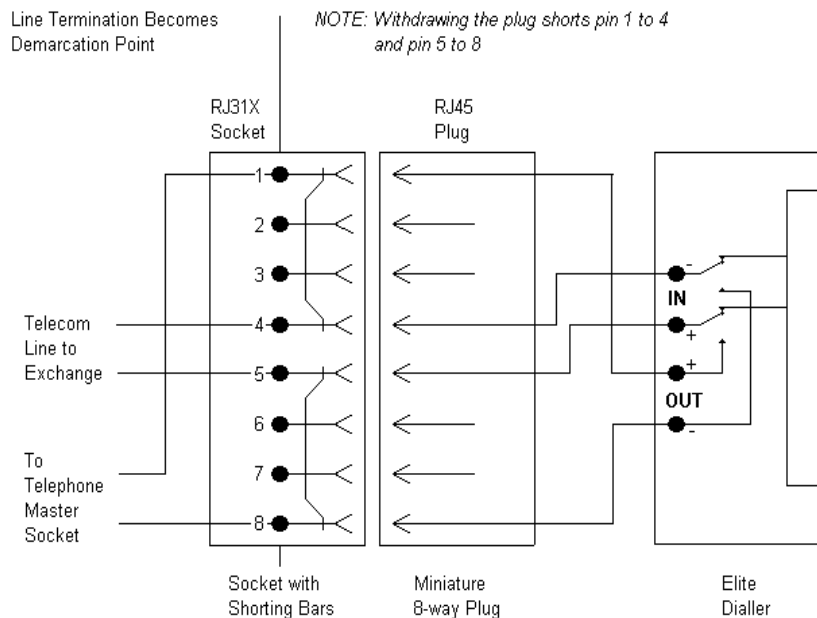

NOTE: The telephone line must not enter the cabinet through the same cable entry hole as any 230 volt mains cables. A separate cable entry must be used for 230 volt cabling

When using one of the knock-outs around the side of the cabinet for supply entry, a suitable bushing must be used where the supply cables pass through a knock-out.

The transmit level from this device is set at a fixed level and because of this there may be circumstances where this device does not give its optimum performance. Before reporting such occurrences as faults, please check the line with a standard Telepermitted telephone, and do not report a fault unless the telephone performance is impaired.

This automatic dialling equipment shall not be set up to make calls to the Telecom "111" Emergency Service

The flexibility of the system is further extended by the way in which you can assign different reporting formats to each of the **six** possible phone numbers.

CONTACT ID CODE SUMMARY

In addition to the programmable Contact ID Event Code assignments defined at P601E - P636E there are a number of fixed event codes. The programmable and fixed event codes are all listed in the table below. Associated with the fixed and programmable event codes, there are a number of extension codes, that are also listed below. This extensions list is for your reference only and can not be changed in programming.

Event	Code	Extension	Comment
Cabinet Tamper	137	120	Panel & Sat Tamper etc
Zone Tamper - Low (short circuit)	137	001 to 008	Zones 1-8
Zone Tamper - High (open circuit)	137	009 to 016	Zones 1-8
Keypad Tamper (Wrong Code)	137	101	At keypad #1
		102	At keypad #2
		through to 108	At keypad #8
		120	At keypad #1
Keypad Panic	120	101	At keypad #1
		102	At keypad #2
Duress Alarm	121	through to 108	At keypad #8
		001	At keypad #1
Arm by "ARM key (shortcut)	408	000	User number zero
Arm by user code	401	001	User #1
		002	User #2
		through to 024	user #24
Arm by Radio-key	407	001	Radio User #1
		002	Radio User #2
		through to 020	Radio User #20
Arm by Command Control (remote set)	401	090	Command Control user
Arm by Time Zone	403	000	Time Zone arming
Arm by Key-switch	409	001	Key-switch Arm/Disarm KS#1
Arm by Key-switch	409	002	Key-switch Arm/Disarm KS#2
Arm by Up/Download	400	000	Remote User Number
Arm by DTMF remote control	400	000	Remote User Number
Radio-key Panic	120	001	Radio User #1
		through to 020	Radio User #20
		130	Zone 1
Radio PIR / Reed Switch Activation	130	001	Zone 1
		002	Zone 2
		through to 016	Zone 16
System Battery Low	302	000	Control Panel Battery low
Mains Fail	301	000	230v mains to control panel lost
12V Supply fuse Fail	312	000	12V Fuse F1 or F2 blown
Radio PIR / Reed Switch Battery Low	384	001	Zone 1
		002	Zone 2
		through to 016	Zone 16
Radio-key Battery Low	384	051	Radio-key #1
		052	Radio-key #2
		053	Radio-key #3
Radio Zone Supervised Failure	381	through to 070	Radio-key #20
		001	Radio Zone #1
Zone Inactivity Alarm	391	through to 016	Radio Zone #16
		001	Zone #1
TEST Calls	602	000	24 hour test
Zone Bypasses	570	001	Bypass Zone 1
		002	Bypass Zone 2
		through to 016	Bypass Zone 16
Phone Line Failure	351	000	Reported when line is restored
Stay Mode (part set)	441	000	Arm by "Stay" Button
		001	User 1
		through to 024	User 24
Duress Alarm	121	101	Duress at Keypad #1
		102	Duress at Keypad #2
		through to 108	Duress at keypad #8

